

# Optimizing soil moisture for plant production

The significance of soil porosity

FAO  
SOILS  
BULLETIN

79

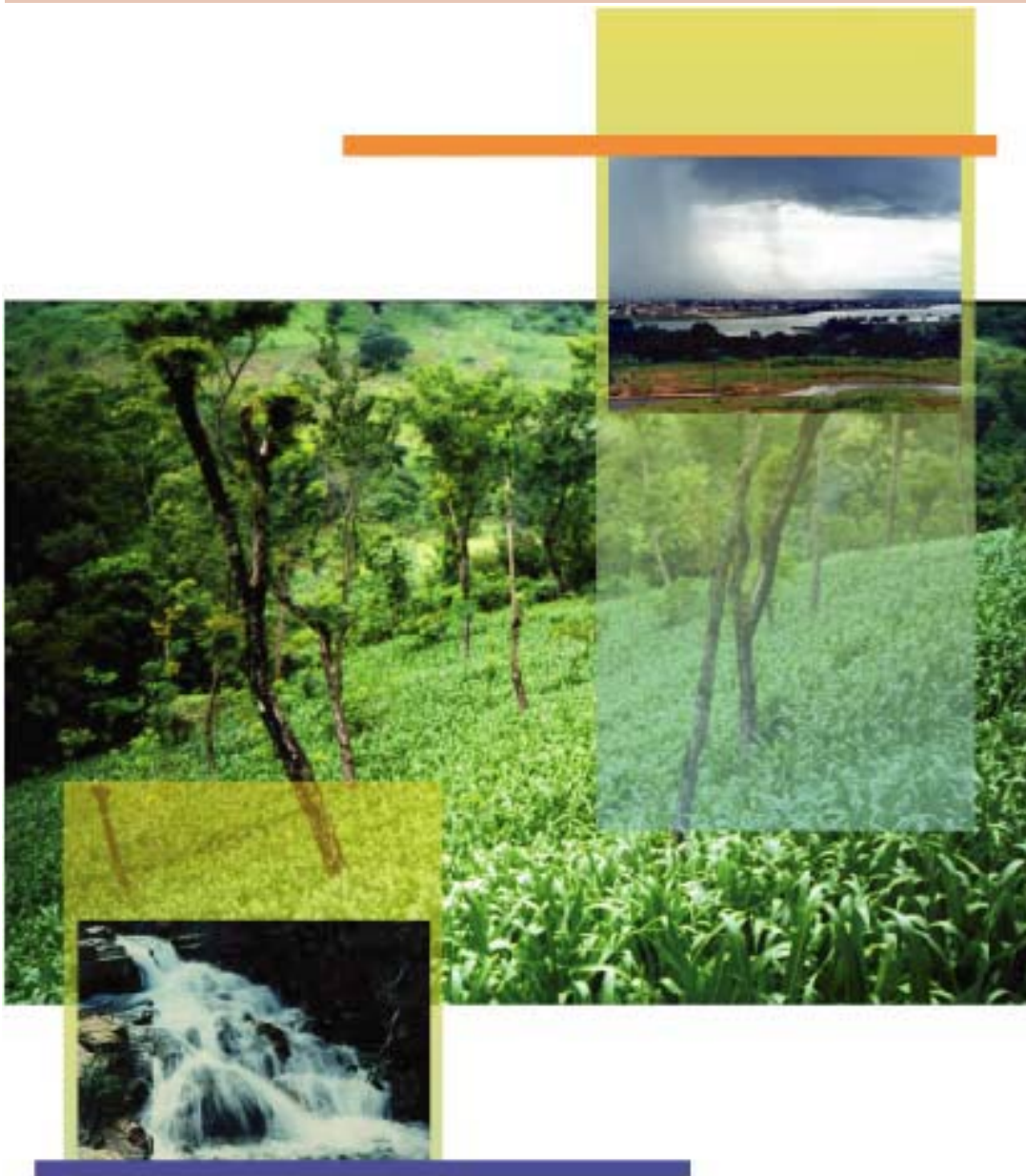

## Preface

As the human population grows, notably in the tropics and subtropics (where many rural people live in poverty), the difficulties of increasing food production also increase. In these areas, average crop yields are in gradual decline. In spite of improved plant breeding, the rates of rise in potential yield are slowing down. Problems caused by erosion and lowland flooding are more frequent, providing evidence of ecological instability in upland areas. Water tables are falling as a result not only from drought, but also from overuse. People without formal land rights cultivate ever-larger areas of steep slopes and other marginal land.

As good land for the lateral expansion of agriculture becomes scarcer, there will be increasing need to intensify land use without causing a decline in productive potential.

There are experiences in a growing number of countries indicating that an agricultural revolution based on principles of better soil management can have a significant positive impact on the sustainability and productivity of agriculture.

Soil moisture is often neglected, but improved soil moisture management is crucial for sustainable improvement of food production and water supply. A wider perception of soil productivity and the reasons for soil erosion and runoff will contribute to achieving higher, profitable and sustainable plant production and to improve the regularity of streamflow.

Reduction of a soil's capacity to accept, retain, release and transmit water reduces biomass productivity, whether of crops, pasture species, shrubs or trees. Soil porosity is closely linked with yields, with the economics of farming and with the sustainability of farm families' livelihoods. Farmers are aware that land cleared from previously undisturbed vegetation provides "free fertility" from which the first crops benefit. But they also know that after a few seasons, productivity declines and that part of this decline is associated with the degradation of soil physical conditions. It is less commonly recognized that this soil damage and the loss of organic matter results in increased surface runoff and reduced soil moisture status.

People are aware of problems of water shortage and soil loss, but despite continued efforts, effective means of overcoming them have not become widespread. However, there are examples in parts of Brazil, Niger and Kenya where better understanding and care of the land are avoiding or reducing water shortages. This is being achieved by increasing rainwater infiltration into the soil, where it is retained for plant use or moved below the root zone to the groundwater.

Where surface runoff is a problem, it can indicate that the soil has become unreceptive, less porous and that much of the rainfall is ineffective in supporting plant growth and regular streamflow. The challenge is to enable the entry of as much rainfall into the soil as possible by promoting conditions that simulate an absorptive forest floor. Such conditions will stabilize the landscape, limit erosion and maximize the usefulness of rainfall. It is important to stress that while inadequate soil water supply is a major cause of low crop productivity, the nutritional aspects of crop productivity are also important. Consequently, an integrated approach to solving low crop productivity should always aim at an adequate supply of both soil water and nutrients.

Scientific endeavour will continue to increase our knowledge of the components of these problems and offer partial solutions. However, unravelling details of problems will not automatically result in workable means of solving them. This is because there is too little understanding of some key ecological and ever-changing linkages. For example, it is the complex set of interactions among weather, plants, soils, water and landscape that results in the crop yields each season. Conventional approaches to crop production offer limited scope for future progress. There is a need to think laterally, to see if there are other ways of looking at old assumptions to identify new ways forward.

This book, intended for extension staff and other technicians, as well as farmer leaders, aims to provide a solid basis for sound, sustainable soil moisture management.

This document has been made more user-friendly by presenting a guide for field workers with activities, exercises and discussion topics in non-technical language, and by interspersing the text with illustrations and diagrams. The complete materials of this guide are included on the CD-ROM that accompanies this document. The emphasis in this CD-ROM is on the use of careful field observations of soil and plant indicators to identify soil water problems.

## Contents

1. INTRODUCTION	1
A way forward	6
The hydrological cycle	9
2. HYDROLOGY, SOIL ARCHITECTURE AND WATER MOVEMENT	9
Catchments and watersheds	11
Soil architecture and the importance of pore spaces in soils	17
Soil water movement	19
Infiltration of rainwater into soil	20
Percolation of rainwater through soil	21
Loss of water vapour from soils	21
Water movements into and through a plant	21
Water stress – nutrient interactions	22
Causes of restricted rooting	23
Indicators of restricted rooting	25
3. RAINWATER, LAND PRODUCTIVITY AND DROUGHT	27
Rainwater for improving yields	27
Deteriorating water supply	28
Indicators of deteriorating water supply	29
Soil productivity and soil erosion	29
Soil productivity	29
Soil erosion	33
Plant-damaging drought	36
Making droughts worse	37
Shortening the duration of drought	37
Changing the perspective on saving soils	39
Care about roots, soil organisms and water	40
4. MINIMIZING WATER STRESS AND IMPROVING WATER RESOURCES	43
Improving restricted rainfall infiltration	43
Improving the infiltration capacity of the soil surface	43
Using surface residue covers to increase infiltration and reduce runoff	44
Mechanisms by which surface residue covers enhance rainwater infiltration	46
Advantages of surface residue covers	46
Constraints to using surface residue covers	47
The amount of residues needed	47
Conditions favouring the adoption of surface residue covers	47
Fallowing under cover crops or natural vegetation	47
Temporary closure of grazing lands and subsequent protection	48
Importance of forest protection for water infiltration	48
Increasing the period for infiltration by detaining runoff with physical structures	49

---

Contour field operations	50
Constraints of surface irregularities formed by contour field operations	51
Conditions favouring the adoption of contour field operations	51
Narrowly spaced contour planting ridges and tied ridges	51
Advantages of narrowly spaced contour ridges and tied ridges	52
Constraints of narrowly spaced contour ridges and tied ridges	53
Conditions favouring the adoption of narrowly spaced contour ridges and tied ridges	53
Impermeable and permeable contour barriers at discrete intervals downslope	53
Conditions favourable for adoption of impermeable cross-slope barriers for water conservation	55
Permeable cross-slope barriers	55
Bench-type terraces	55
Deep tillage to increase subsoil porosity and permeability	56
Reducing water losses from evaporation and excessive transpiration	56
Minimizing evaporation from the soil surface	57
Reducing excessive transpiration	57
Weed control	57
Windbreaks	58
Conditions favouring the adoption of windbreaks	59
Shade	59
Reducing rainwater drainage beyond the rooting zone	60
Soils without restricted rooting	60
Increasing available water capacity of soil	60
Dry planting	60
Improving plant nutrition for early root development	61
Introducing deep-rooting crops	61
Improving soils with restricted rooting	61
Conditions favouring the adoption of biological methods	63
Mechanical solutions to physical root restriction	63
Mechanical disruption of shallow root-restricting layers	63
Mechanical disruption of moderately deep root-restricting layers	64
Mechanical disruption of very deep root-restricting layers in the subsoil	66
Conditions favouring the adoption of mechanical methods	69
Chemical solutions to restricted root growth	69
Maximizing usefulness of low and erratic rainfall	69
Match land use to soil characteristics	69
Use of drought-resistant and drought-escaping crops and varieties	70
Increase crop water use efficiency	71
Selecting water-efficient crops	71
Adjusting plant population to expected rainfall	72
Applying fertilizers	72
Weed control	73
Seed priming	73
Early planting	73
Accumulate moisture from one season to the next	74
Water harvesting	74
Zai pits or Tassa	76
Half moons (demi-lunes)	78

---

Contour stone lines	78
Contour earth ridges and bunds	79
Retention ditches	79
Retention pits	80
Retention basins	80
Farm ponds	80
Floodwater harvesting and water spreading	80
Collaborative stakeholder participation	80
Need for a facilitator	81
Need to tackle root causes	81
Participatory identification and prioritization of soil water problems	81
Participatory identification of the root causes	81
Participatory identification of possible solutions for testing	82
Participatory selection of possible solutions for testing	82
Participatory testing and evaluation of possible solutions	84
5. CONSERVATION AGRICULTURE	85
Improving soil conditions	85
Residue-based zero tillage in Brazil and Paraguay	85
History	87
Implementing conservation agriculture	88
Effects of conservation agriculture	91
Effects on crop yields	91
Effects on soil moisture	91
Effects on some other soil health indicators	93
Effects on erosion and runoff	94
Effects on catchment hydrology	95
Effects of zero tillage systems on farm economics	95
Observations about residue-based zero tillage systems in Latin America	97
Constraints of conservation agriculture and some approaches to overcome them	98
REFERENCES	101

## Acknowledgements

The authors wish to express their appreciation and gratitude to José Benites, AGLL for the advice on preparing this publication. The authors would also like to thank Peter Craufurd of the Department of Agriculture, The University of Reading for information and help on soil water relations and plant physiology, as well as John Gowing for supplying illustrations.

The authors also highly appreciated the valuable comments provided by Amir Kassam, SDRC , P. Koohafkan, AGLL and Bob Steward, West Texas A&M University on draft versions. Special thanks are due to Peter Brinn and Sandrine Vaneph for their comments and the consequent editing they provided. Also valuable were the inputs, final editing and proof reading by Robert Brinkman.

Finally, the authors thank to Antonio Castellanos for his efficient preparation of the text and Lynette Chalk for formatting of this document.



## List of figures

1. Human-induced soil degradation	3
2. Simplified diagram of the hydrological cycle	9
3. The sequence of destinations of rainwater	10
4. Catchment vs. watershed as distinct but interrelated features of the landscape	11
5. A nested hierarchy of interrelated constructed and natural catchments	12
6. Typical available water capacities of different textured soils	15
7. Runoff and percolation: two routes for rainwater	15
8. Sideways development of tap-root of a wild okra weed growing in a maize field; the change in growth habit of the root is caused by a compacted hoe pan at the base of the ridges formed by hoeing to the same depth (and the passage of feet during the rains) over many years	24
9. Examples of rooting pattern and growth habit when roots are physically impeded or prevented from penetrating a root-restricting soil layer	26
10. Soil structure and its impact on soil processes and agricultural sustainability	31
11. Where the soil is not crusted and is protected by litter from the force of raindrops more water enters the soil than where the surface is bare	31
12. Yield after erosion is related to the quality of soil remaining, not to quantity and quality of soil removed	34
13. Within-season droughts with annual rainfall totals of 1 275 mm (1915), 776 mm (1965) and 340 mm (1972) in Hyderabad, India	38
14. Root systems of two young tea plants of the same clone (MT12) without and with irrigation, after 9 months in the field	39
15. Fate of rainwater for three soil management practices	53
16. Fanya Juu terrace at construction and after several years	55
17. Example of a paraplow	65
18. a) Shows the depth of shank penetration for in-row subsoiling in relation to the root-restricting horizon, b) shows a cross-sectional view of the effect on crop root development	66
19. Example of concentrated runoff harvesting by diverting ephemeral flows into retention ditches or basins	75
20. Permeable rock dams with contour stone bunds for floodwater harvesting and water spreading	75
21. Example of possible solutions to the problem of high runoff	82
22. Example of a problem-cause tree for high runoff	82
23. The growth of residue-based zero tillage in Brazil 1972 –1999	88
24. Soil moisture available to plants at different depths during the vegetative phase of wheat growth, under three methods of soil preparation	92
25. Frank' Anna farm's production graphs 1978-2000 in Paraná, Brazil	93



## List of tables

1. Arable land and permanent crops area (1 000 ha) per 1 000 capita by region	1
2. Decline in average yields of unfertilized maize in kg/ha – local/traditional varieties, Malawi	2
3. Decline in response of local maize to fertilizers in Malawi	2
4. Three-year running means of five major crops' yields (kg/ha), Lesotho	2
5. Differences in available water capacities between two East African soils	15
6. Functions and sizes of soil pores	18
7. Dimensions of roots of three grasses in sample of 0.688 litre taken to a depth of 15 cm	30
8. Annual rainfall totals at Indore, India	36
9. Length of growing period for different soil available water capacities in bimodal rainfall areas of semiarid India	69
10. Effect of P fertilizer and soil depth on rainwater use efficiency and sorghum grain yield in Botswana	73
11. Effects of improved zaï on sorghum yields over 2 years	77
12. Yields, net value of production and returns to labour from existing tassa/(zaï) and demi-lunes, Niger	78
13. Checklist of possible solutions to soil water problems that will need validating and adapting with farmers	83
14. Yields of wheat and soybean, averaged across rotations, under three different soil preparation methods in Londrina, Brazil	91
15. Changes in mean diameter and stability of soil aggregates after 7 years of rotation under residue-based zero tillage (ZT) and conventional tillage (CT) in Paraná, Brazil	93
16. Buildup of soil organic matter under ZT compared with conventional cultivation	94
17. Influence of different methods of soil preparation on population of earthworms in Paraná, Brazil	94
18. Number of maize roots to depth of 1 m after 15 years of zero tillage (ZT) and conventional tillage (CT) in Paraná, Brazil	94
19. Losses of soil and water under conventional tillage (CT) and residue-based zero tillage (ZT)	94
20. Comparative short- and long-term economic results on typical 135 ha farms with tractor power, from conventional tillage (CT) and residue-based zero tillage (ZT) in San Pedro and Itapua regions, Paraguay	96
21. Summary of farming system results on small farms with cotton, soybeans, tobacco, maize	96

## Acronyms

ABLH	Association for Better Land Husbandry
ABRACOS	Anglo-Brazilian Amazonian Climate Observation Study
AWC	Available Water Capacity
CA	Conservation Agriculture
FAO	Food and Agriculture Organization of the United Nations
FC	Field Capacity
FEBRAPDP	Federação Brasileira do Plantio Direto na Palha
IAPAR	Paraná State's agricultural research station, Brazil
Instituto CEPA/SC	Santa Catarina State's Institute for Planning and Agricultural Economics, Brazil
MAI	Moisture Availability Index
NGO	Non-Governmental Organization
PWP	Permanent Wilting Point
SUREHMA	Paraná State's agency for water resources and the Environment, Brazil
SWC	Soil and Water Conservation
TRIEA	Tea Research Institute of East Africa
WSC	Water and Soil Conservation
ZT	Zero Tillage

## Glossary of soil moisture terms

*Field Capacity (FC)* – refers to the relatively constant soil water content reached after 48 hours drainage of water from a saturated soil. Drainage occurs through the transmission pores (greater than about 0.05 mm diameter; but note that field capacity can correspond to pores ranging from 0.03 to 0.1 mm diameter). The FC concept only applies to well-structured soils where drainage of excess water is relatively rapid; if drainage occurs in poorly structured soils, it will often continue for several weeks, and so poorly structured soils seldom possess a clearly defined FC. FC is best determined in the field by saturating the soil and measuring its water content after 48 hours of drainage have elapsed. Soil at field capacity feels very moist to the hands.

*Permanent Wilting Point (PWP)* – refers to the water content of a soil that has been exhausted of its available water by a crop, such that only non-available water remains. The crop then becomes permanently wilted and cannot be revived when placed in a water-saturated atmosphere. At this point the soil feels nearly dry or only very slightly moist.

*Available Water Capacity (AWC)* is the water available for plant growth held between Field Capacity and Permanent Wilting Point.

*Saturation* – refers to a soil's water content when practically all pore spaces are filled with water. This is a temporary state for well-drained soils, as the excess water quickly drains out of the larger pores under the influence of gravity, to be replaced by air.

## List of background documents (available on CD-ROM)

1. Preliminary activities: community maps and transect walks
2. Activities: exploring soil hydrology, biology, porosity, etc.
3. Discussion topics for farmers' groups
4. Assessing project success: the significance of farm families' comments
5. Reinterpreting reports
6. An example of how to begin the steps of improvement
7. Soil moisture use under different land uses and vegetation
8. "The soil maker of Chile"
9. List of publications about cover crops
10. Demonstrating the importance of soil porosity

**System requirements to use the CD-ROM:**

- IBM compatible with Microsoft® Windows 95 / 98 / 2000 / Me / NT / XP
- 64 MB of RAM
- 50 MB of available hard-disk space
- Internet browser such as Netscape® Navigator or Microsoft® Internet Explorer
- Adobe Acrobat® Reader 5.0 (included on CD-ROM); to be installed in case of problems with previous versions of Adobe Acrobat® Reader

# Chapter 1

## Introduction

In many parts of the subhumid and semiarid tropics, crop yields are declining on response to inputs such as fertilizers, and droughts and shortages of irrigation water are increasingly evident.

Sub-Saharan Africa and Asia pose two different challenges in raising food production to meet their food needs:

- Much of the agriculture in sub-Saharan Africa and Asia is not irrigated but rainfed, with the associated uncertainty as to the onset, reliability and amounts of rainfall each year. Limitations to the expansion of the existing cultivated area are increasingly those of uncertain rainfall and of the topographic and chemical hazards associated with taking marginal lands into cultivation. In sub-Saharan Africa a growth rate in food production of about 4 percent per year is needed to keep up with population growth to 2030, whereas over past years only about 2 percent rate per year has been achieved (FAO, 1996b).
- The main crop in much of Asia is rice, both irrigated and rainfed in wet valley lands and also grown on rainfed uplands. Three major problems limit the expansion of irrigated rice production into the future: (i) increasing competition for irrigation water from non-agricultural uses; (ii) even with the development of high-yielding rice varieties and hybrids yields are rising more slowly than previously and appear to be approaching a plateau of productive potential; (iii) only about 5 percent of the original total of potentially irrigable land might still remain by 2030 for expansion of irrigated rice (except in India) (FAO, 2000a).

The problem of lower annual increases in yield per hectare is a not confined to irrigated rice. Wheat and maize are also apparently reaching similar plateaus. For the three major staple crops (paddy rice, wheat and maize) the average yield increases between 1963 and 1983 were respectively, 2.1, 3.6 and 2.9 percent per year; but in the 10 years 1983-1993 the rates of increase had fallen respectively to 1.5, 2.1 and 2.5 percent per year (FAO, 1996b).

Some 40 percent of all food is produced under irrigation, from about 18 percent of the world's area of arable land plus permanent crops, with 60 percent produced under rainfed agriculture. As populations have risen this arable land and permanent crops area per head has been falling, except in the case of Europe (Table 1).

There is evidence that yields per hectare of some unfertilized rainfed crops are declining – as indicated in Table 2.

Fertilizer trials with local maize varieties have shown that responses to fertilizers have also been declining for years (Table 3).

**TABLE 1**  
**Arable land and permanent crops area (1 000 ha) per 1 000 capita by region (FAOSTAT Database, 2002)**

Region	1975	1995
Africa	0.42	0.29
Asia & the Pacific	0.21	0.18
Europe	0.30	0.43
Latin America & Caribbean	0.39	0.33
North America	0.95	0.75
World	0.35	0.27

In the State of Paraná in southern Brazil, from the time of clearing the land from native forest decades ago, yields of crops under conventional tillage fell between 5 to 15 percent in 10 years. This was accompanied by severe losses of soil, associated organic matter and applied nutrients, resulting in downstream flooding, sedimentation and other damage (Plates 1 and 2).

Records from Lesotho show that mean yields of major crops (generally without added fertilizers) declined between 1978 and 1986, related to a combination of adverse weather conditions, decline in soil conditions, and recurrent erosion and runoff. A three-year running mean of yields has been used, in order to smooth the effects of between-year weather variations (Table 4).

TABLE 4

**Three-year running means of five major crops' yields (kg/ha), Lesotho**  
(after Lesotho Government, 1987)

Year	Maize	Sorghum	Beans	Wheat	Peas
78/79–80/81	953	1 031	607	926	889
79/80–81/82	843	761	453	811	651
80/81–82/83	769	654	395	653	521
81/82–83/84	714	607	290	562	447
82/83–84/85	732	668	253	530	428
83/84–85/86	723	663	242	556	441

At the same time, it has been widely observed that ongoing land degradation across topographic catchments has resulted in increasingly irregular streamflow, with more floods of muddy water in the rainy season and declining volume and duration of streamflow during the dry season (Plates 3, 4 and 5).

Human-induced agricultural land degradation is widespread in irrigated and rainfed land and in both tropical and temperate zones. Land degradation represents a challenge to the sustainability of farming systems in all regions, even those of low population densities (after FAO, 2001a). In rainfed lands, compaction, erosion and runoff are significant problems. On irrigated lands, problems are often those of poor drainage control, salinization and compaction leading to nutrient deficiencies (Figure 1).

Such problems are not confined to tropical areas. Clear-felling of trees (Plate 6), grazing on very steep slopes (Plate 7) and the compacting effects of farm machinery (Plate 8) result in excess water runoff and erosion in temperate zones. Plate 9 shows a soil that has been compacted at about 8-10 cm depth by repeated disking, which has the effect of reducing its effective depth. Under native vegetation, this soil is deep and water absorptive. The difference in the growth of the soybean plants between the top left and upper right of the photo can be related both to the effects of erosion and to induced soil moisture shortage in the root zone.

Estimates of damage caused by compaction and erosion in the Eurasian region suggest that about 327 million hectares of land in Eurasia have been severely affected by wind and

TABLE 2

**Decline in average yields of unfertilized maize in kg/ha – local/traditional varieties, Malawi** (Douglas, 1994)

District	1957–1962	1985/1986–1986/1987
Lilongwe	1 760	1 100
Kasungu	1 867	1 120
Salima	1 693	1 060
Mzuzu	1 535	775

TABLE 3

**Decline in response of local maize to fertilizers in Malawi** (Malawi Government, 1957–1985)

District	Mean response rate 1957–1962 (kg maize/kg N)	Mean response rate 1982–1985 (kg maize/kg N + P <sub>2</sub> O <sub>5</sub> )
Lilongwe	23	13
Kasungu	24	18
Salima	25	17
Mzuzu	32	18

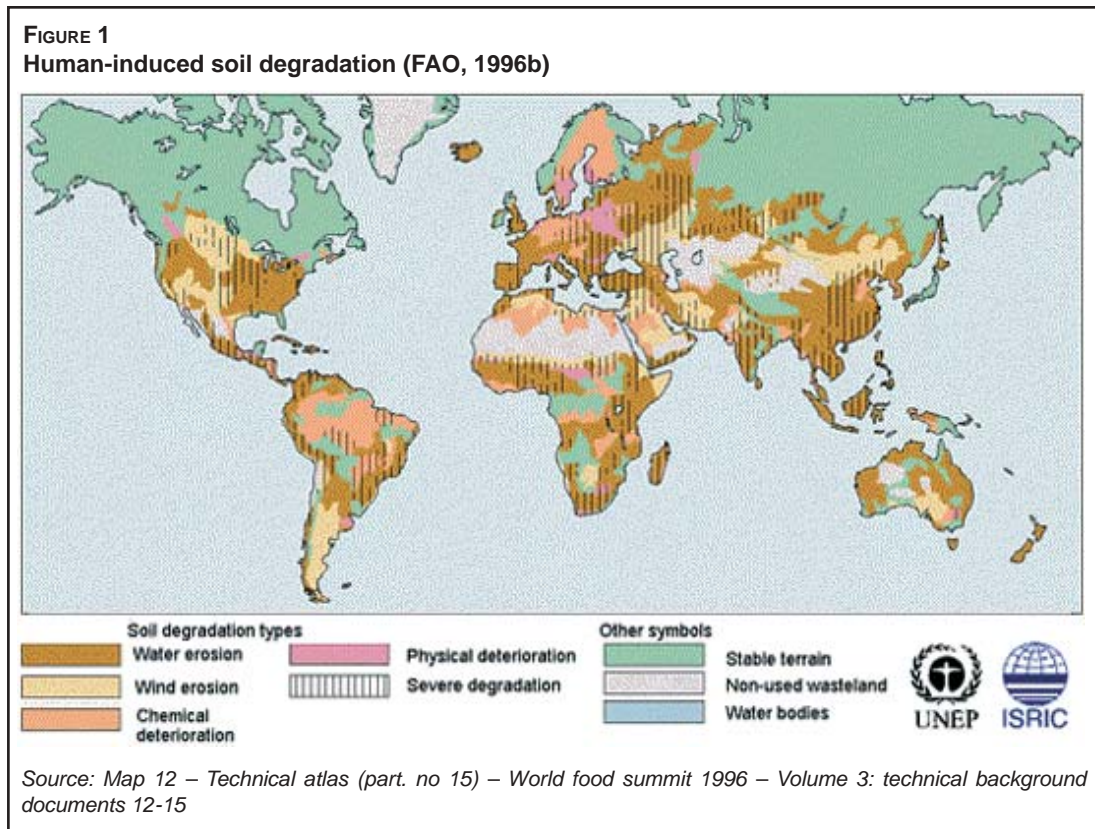
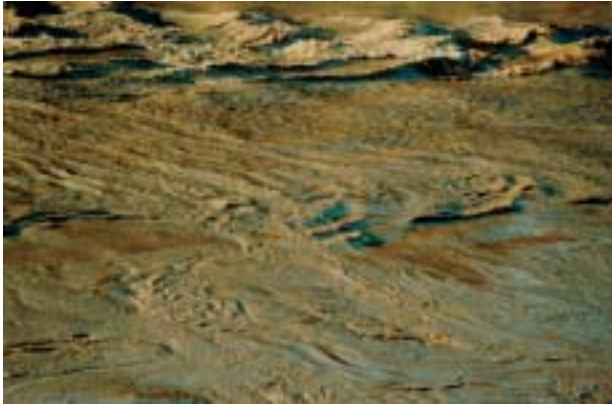

**PLATE 1**  
**Clear water, from stable absorptive land. Cerrado, Brazil**  
 [T.F. Shaxson]

water erosion. Approximately 170 million ha of land have been affected by soil compaction. Conservative estimates calculate a production loss of 15 million tons of grain, two million tons of sugar beet and 500 000 tons of maize. Others calculate a 16-27 percent decrease in production as a result of compaction, with a loss of 50 million tons of grain production alone (Karabayev *et al.*, 2000).

A study of the effects of soil compaction on wheat production in New Zealand showed that as the soil becomes increasingly degraded, costs rise as yields fall, squeezing margins of profit per hectare (Shepherd, 1992). This indicates a wider problem that, as yields begin to decline, farmers may apply more fertilizer, masking the underlying decline into unsustainable and uneconomic production. A survey of small resource-poor farmers in central Paraguay showed that as erosion and runoff continued, yields of cotton, tobacco, maize and other crops declined.





**PLATE 2**  
 This floodwater is turbid with eroded soil: it did not enter the ground first to emerge clean into the river. Caledon River, Lesotho  
 [T.F. Shaxson]

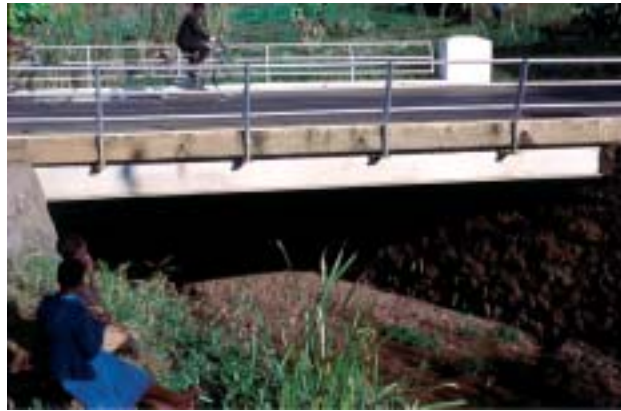

**PLATE 3**  
 The Namadzi stream, arising in a poorly managed cultivated hilly catchment, is empty of water in the dry season. Namadzi, Malawi  
 [T.F. Shaxson]



**PLATE 4**  
 From the same viewpoint upstream of the road-bridge, in the rainy season just after a storm the Namadzi stream is a raging, soil-filled torrent. Namadzi, Malawi  
 [T.F. Shaxson]

**PLATE 5**  
 These mature trees must have grown up along and above the riverbank. But destruction of soil porosity and permeability by bad husbandry in the catchment has resulted in heightened flood peaks which have eroded away the riverbanks and left the trees marooned in the middle of the river bed. Mikolongwe, Malawi  
 [T.F. Shaxson]



**PLATE 6**  
**Clear-felling of planted forest and destruction of ground cover on steep slopes bares the soil and encourages runoff and erosion. Palmerston North, New Zealand**  
 [T.F. Shaxson]



**PLATE 7**  
**Reduction of ground cover due to severe grazing by sheep causes landslips, with loss of plants, water and soil. Palmerston North, New Zealand**  
 [T.F. Shaxson]

As a result net farm incomes fell and farmers could no longer afford to buy equipment or inputs that might help to reverse the downward trend. This has led to farms being abandoned and desperate families migrating to the cities in search of income that farming could no longer provide (Sorrenson *et al.*, 1998).

Potential sources of growth in overall output are: (1) expansion of arable land area (2) increases in cropping intensities to give greater harvested area; (3) growth in yield per hectare (FAO, 2000a). Considering the present problems with production noted above, these expectations are optimistic if areas of already-damaged soils continue to be managed in the same way as in the past. Expansion of arable land will be limited because almost all lands of good and moderate quality have been settled. Expansion of the cultivated area will be onto land with increasing difficulties and hazards, which will reflect negatively on the yields and economics in crop production of both rainfed and irrigated crops. Increases in cropping intensity with shorter (or even no) regular recuperative periods during which damaged soils can recover their soil fertility will result in continued and worsening land degradation. Rates



**PLATE 8**  
**Use of heavy farm machinery can compact soil and encourage runoff even where rainfall is never very intense. Abbotsbury, England**  
 [T.F. Shaxson]



**PLATE 9**  
**Effects of compaction on root habitat of soybean**  
*[T.F. Shaxson]*

of yield increase are tending to fall and upper limits of potential yield, at least of key grain crops, are apparently being approached where high inputs are used on the best soils.

### **A WAY FORWARD**

Intensification is the only option to increase usable biomass and available water per unit area of land. The challenge is to achieve intensification without causing more damage to soils and to the quantity and reliability of water supplies. Unfortunately, past attempts to intensify production using conventional methods have often resulted in damage to the soil.

The sustainability of agriculture depends not only on the soil continuing to be a fit place for crops, pastures and trees, but also on young people being enthused by farming to provide a continuity from one generation to the next, developing and carrying forward up-to-date knowledge and relevant skills in the husbandry of plants, animals and land.

How can farming return to being a way of life which is satisfying to many and which encourages them to remain in the rural areas? How can sufficient water be ensured, both for plant growth and for the regular flow of rivers, when much recent experience shows increasingly severe effects of drought on crop plants and a decline in the regularity and volume of river flow? How to achieve not only greater total output, but also better quality and improved food security over the year? How to produce a greater variety of foods to improve nutrition and health and reduce poverty by generating income? Conventional approaches seem to be inadequate for the task, despite the efforts of many to date.

Key parts of any strategy to address these issues include:

- *Recognizing the soil as a key and living component of the environment.* To date it has received far less attention in comparison with the above-ground components, which are more readily perceived.
- *Encouraging the inherent capacities of life itself.* Particularly the ability of bacteria, fungi, soil fauna and plants to continually colonize and modify habitats.
- *Prolonging the usefulness of rainwater and organic matter.* By recycling through different biotic processes as many times as possible.

In 1971 D.A. Poole wrote:

*“We must begin to regard our individual disciplines as part of a whole – an ecological whole – as one of the several moving parts that, depending on how applied, either catalyses or obstructs the working of the whole. We must recognize and promote the ecology of our individual disciplines, none of which can afford to act alone. The public cares less about the technical aspects of soil conservation, forestry, wildlife or any other discipline than it does about their environmental effects. People will support – with money and voices – those professionals whose programs truly assure them of environmental improvement. And they will resist – as they are doing so strongly today – those programs based more on textbook philosophy than on environmental acceptability.”*

This is as true now as when it was written more than 30 years ago.



## Chapter 2

# Hydrology, soil architecture and water movement

### THE HYDROLOGICAL CYCLE

An understanding of the hydrological cycle is essential for the effective management of rainwater and soil water. Water occurs not only as a liquid, but also as a solid (e.g. hail, snow) and as a gas - water vapour. The total amount of water in the world is constant, but water is continuously changing from one form to another and is continuously moving at different speeds. These interrelationships are shown in a simplified form at a regional scale in Figure 2.

Heat from the sun causes water at the surface of oceans, lakes and rivers to change into water vapour in a process called evaporation. Transpiration in plants is a similar process, in which water is absorbed from the soil by plant roots and transported up the stem to the leaves, from where it is released (transpired) as water vapour into the atmosphere.

As the water vapour produced by evaporation and transpiration rises into the atmosphere, so the temperature decreases and water vapour changes into water droplets (condensation), which accumulate as clouds. Depending on their size, these may be released as rainfall.

Once rainfall reaches the land surface it can infiltrate into the soil, run off over the surface as overland flow, or accumulate on plant leaves or in puddles from where it evaporates back to the atmosphere. A combination of these processes is commonly the case.

The rainfall that infiltrates into the soil forms part of the soil water, of which some may be used by plants for transpiration, some may return to the atmosphere through evaporation from the soil surface, and some – if sufficient infiltration occurs – may move beyond the rooting zone to the groundwater. Annex 7 deals with soil moisture use under different land uses and vegetation.

The groundwater moves laterally and slowly towards the sea to complete the hydrological cycle, but part of it will seep into springs, streams, rivers and lakes on the way. In this way the groundwater maintains the water level in wells, and the continuity of river and streamflow during dry periods (referred to as base flow).

**FIGURE 2**  
Simplified diagram of the hydrological cycle (Adapted from Ward, 1975)

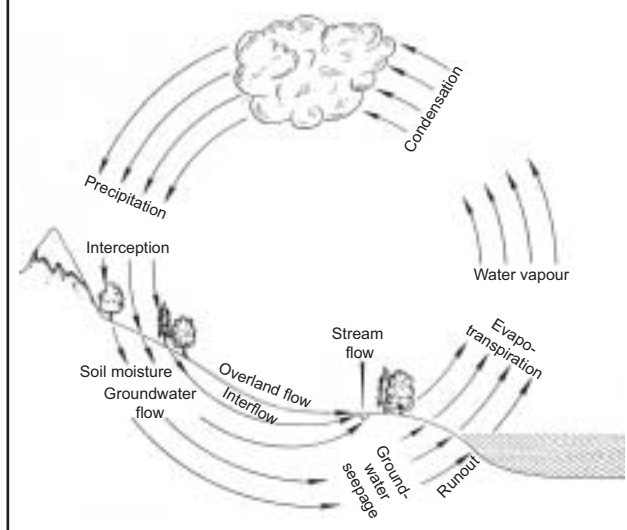

Rainwater that runs off the land moves rapidly downhill towards river courses, contributing to peak flows, and is of great concern. Runoff is not only a waste of rainfall that could have contributed to crop production and groundwater supplies, but it frequently causes floods or damage to roads and farmland, and erodes soil that is redeposited in river courses and reservoirs downstream.

Groundwater is derived from rainwater that has infiltrated into the soil and drained beyond the rooting zone in excess of both the quantity needed for the crop or the vegetation and the water-storage capacity of the soil (FAO, 1995a and FAO, 2002).

Groundwater moves very slowly through subsoil materials in the direction of the dominant drainage course. If its upper surface, the water table, does not sink below the level of the streambed, water is released to springs that feed streams and tributaries. This occurs throughout the year and in this way groundwater acts as a buffer in maintaining stream base flows and water levels in wells during dry periods.

In soils with relatively impermeable subsoil layers beneath more highly permeable layers, perched water tables may develop above the groundwater, due to water being held up by the impermeable layers. The water in a perched water table, sometimes referred to as interflow, will slowly move laterally and may emerge into stream courses or springs at lower elevations. It does not contribute directly to the groundwater. The presence of groundwater or a perched water table is indicated by saturated soils, and usually by a dominance of light grey, bluish-grey, bluish or greenish colours. These colours are typical of certain iron compounds that only form in waterlogged soils where oxygen is lacking.

The amount of rainfall that percolates beyond the lower limit of the rooting zone towards the groundwater will depend on the amount of water used for transpiration by the crops or vegetation. For a particular climate and soil type, forest transpires more water than grassland, which generally uses more water than crops. The high water use by forest is due to its generally greater transpiration rate, the longer period of transpiration compared with crops, and the deeper roots enabling it to absorb water from greater depths. Changes in land use can therefore affect the quantity of water transpired and hence the quantity reaching the groundwater. Replacing forest vegetation with grassland or annual crops may increase deep drainage and so provide higher base flows in streams and rivers. Changes in soil management can also affect the quantity of deep drainage replenishing groundwater. The introduction of poor management practices that increase the

**FIGURE 3**  
The sequence of destinations of rainwater (Shaxson, 2001 after FAO, 1995b)

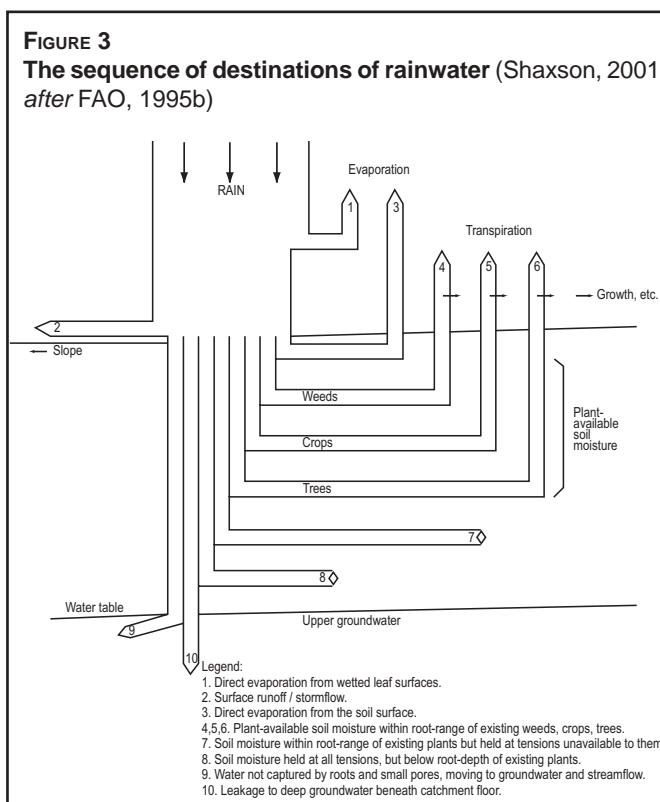

proportion of rainfall lost as runoff will reduce base flows and increase peak flows and the incidence of flooding. Conversely, an improvement in soil and nutrient management will lead to higher grain and foliage production, higher transpiration rates, and hence less recharge.

In order to consider rainwater for plants and for groundwater as parts of a sequence, it is important to have a mental picture of its journey. After passing through the atmosphere in response to gravity, water from rain or irrigation travels to some or all of the following destinations (Figure 3).

Management of the soil can significantly affect runoff; direct evaporation from the soil surface; the amount of soil moisture available to plants within range of their roots; and the depth to which roots can penetrate. How much water reaches each of these destinations over a given period depends on the physical condition of the soil and its influence on infiltration and runoff, and on the atmospheric conditions as they affect evaporation and transpiration.

### Catchments and watersheds

Water caught by a catchment will flow towards the lowest point at the outlet, where it may join water emerging from other catchments. The outer boundaries of a catchment are defined by ridgelines along the crests of the surrounding uplands. From the sides of a valley surface runoff tends to flow perpendicularly to the slope from crest to streamline.

A watershed is the area of land dividing two streamlines. Water moves away from the crest line towards the streamlines on either side. Thus a hill slope can be considered as either the inner slope of a catchment or the outer slope of the watershed. Catchments and watersheds are indicated on maps by the contour lines and by the course of drainage lines (Figure 4).

Underlying geological formations, together with weathering and uplift processes, affect the form of landscapes. They influence the steepness or shallowness of slopes, whether the streamlines are of relatively sinuous shape or with abrupt changes of direction. The flow of water along the streamlines tends to cut the heads of streamlines back into the underlying materials (Plate 10).

For the purposes of enabling rainwater to soak into the soil and controlling the rate of flow of any excess runoff, we can subdivide a given catchment into a more detailed hierarchy of

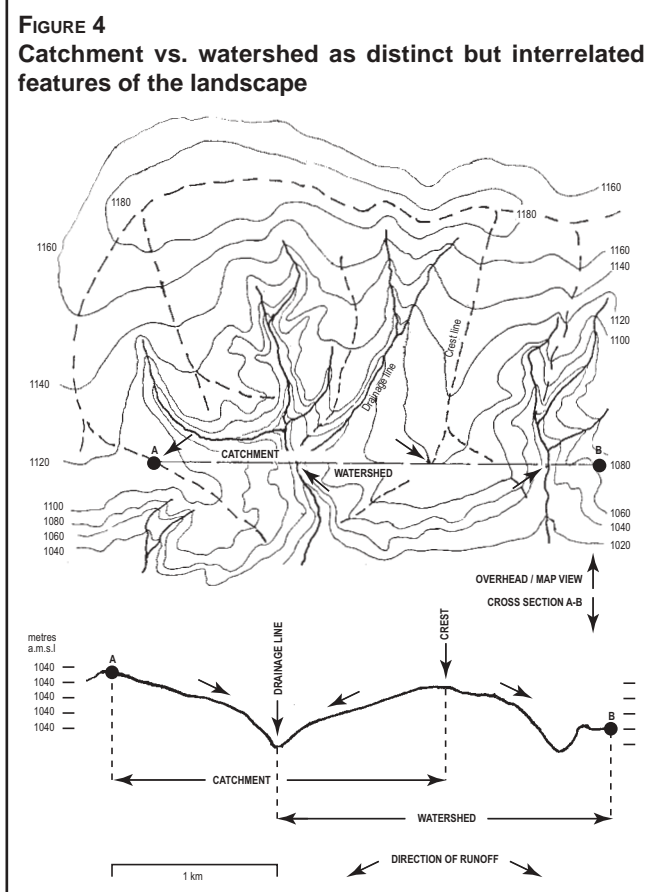



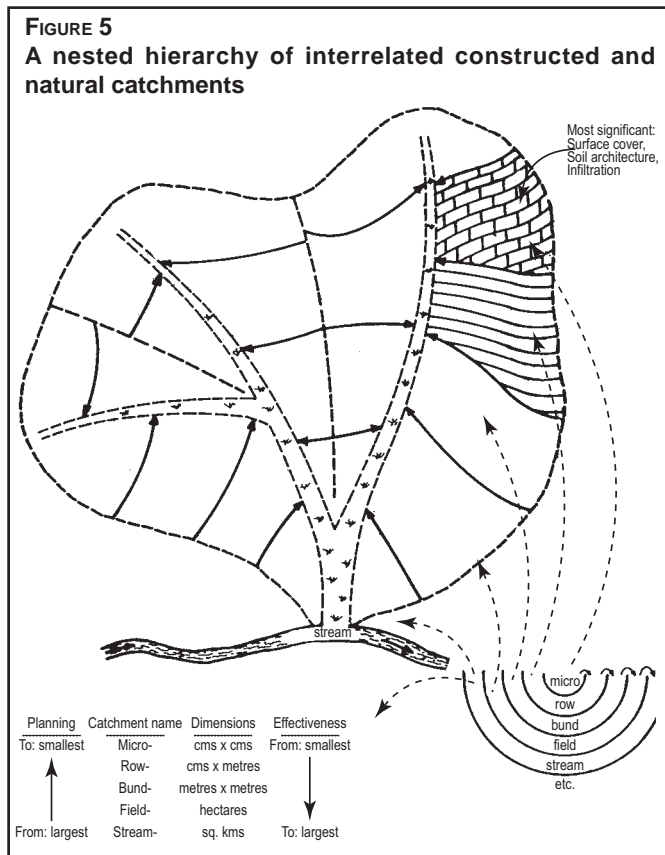

catchments, in which the smallest subdivisions may be measured in square centimetres, the larger in hectares, within catchments of square kilometres. Rainfall entry into the soil depends on the porosity of the soil at any scale, while management of runoff and erosion across the surface also depends on any physical works that may be constructed when rainfall rates exceed even the best infiltration rate (Figure 5).

Overlapping pairs of vertical aerial photographs viewed with a stereoscope provide a three-dimensional view of the landscape and surface features (Shaxson *et al.*, 1977; Carver, 1981). Plate 11 is a stereogram that shows a layout of roads along topographic crests and of conservation banks close to contours that has been designed in conformity with the natural catchments of the landscape. This pattern provides a framework within which planting rows will have been contour-aligned relative to the conservation banks. The maintenance of soil porosity by mulch cover will allow the highest proportion of rainfall to be available as soil moisture for the crops and groundwater for the streams.



**Plate 10**  
**Repeated flows of water cut streambeds downwards and back into an ancient plateau landform; the crests between them divide one catchment from another. Paracatú, Brazil [T.F. Shaxson]**

A stream catchment may be large or small, of steep or shallow slope and composed of natural subcatchments and then of field catchments. Plate 12 shows two of these field catchments, which also form the left-hand side of a watershed whose crest runs along the ridge seen at top right.

In cropping agriculture the next smaller subdivision is the bund catchment, between any pair of physical conservation banks with its ridges and furrows (formal or informal) along planting rows (Plate 13). The physical conservation banks, vegetated with a fodder grass, subdivide the field catchment as well as separating the bund catchments. The aim of these structures is to

conserve water and soil, though their effects on yield are disappointing. Their most significant function is to provide guidelines for contour planting of crop rows.

The smallest subdivision to trap rainwater and give it time to soak in is the microcatchment with its mulch (Plate 14).

In forestry, because the young trees are more widely spaced, the same effect can be obtained by a set of half moon shaped microcatchments, one at each planting position (Plate 15).

Within this overall framework, the key to infiltration is to keep the soil porous with a cover of crop residues, which prevents damaging raindrop impact and provides a substrate for soil organisms (Plate 16).

The conservation effects of forests are due not so much to the presence of the trees themselves but to the litter of fallen leaves, twigs and branches, plus any low-growing vegetation. If the soil surface has not been damaged by trampling, less rainwater will

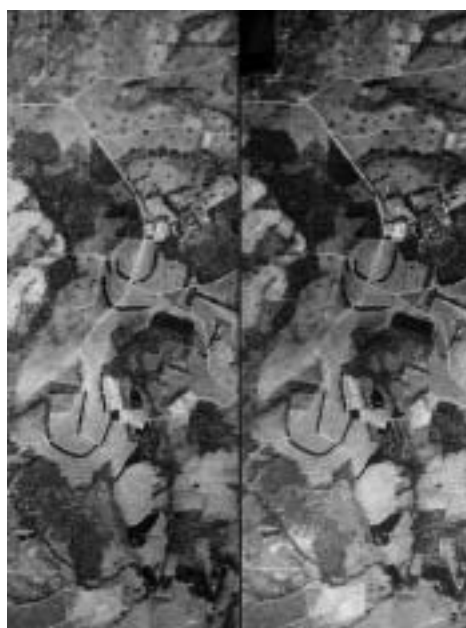

**PLATE 11**  
**Stereogram of a landscape. Malawi**  
*[Government of Malawi]*



**PLATE 12**  
**Two field catchments – parts of the stream catchment whose drainage line runs along the left of the photo. Santa Catarina, Brazil**  
*[T.F. Shaxson]*

**PLATE 13**  
**Two bund catchments interlined with “row catchments” along the planting lines. (Caxambú, Brazil)**  
*[T.F. Shaxson]*





PLATE 14

**A row of microcatchments: one furrow cross tied for water retention, the other covered with a mulch to facilitate rapid infiltration of rainwater; the unmulched furrow also provides a dry-season firebreak between the rows of young tea. Mulanje, Malawi**  
[T.F. Shaxson]



PLATE 15

**Half moons around newly planted *Acacia* seedlings catch and detain rainwater, in similar manner to the cross tied furrows in the previous photo. Dungarpur, India**  
[T.F. Shaxson]

run off and more will infiltrate into the soil (Plates 17 and 18).

How much plant-available soil moisture remains at a given time depends on the texture and porosity of the soil, the previous volume of soil moisture, the volume removed by direct evaporation, evapotranspiration and deep drainage. Irrigation (if available) is normally required when about two thirds of the available water - between field capacity (FC) and permanent wilting point (PWP) - has been depleted. If irrigation is not an option, it makes sense to manage the soil to develop and retain a maximum amount of soil pores of a wide range of sizes. This will maximize the capacity for water retention and enable plants to withstand drought for longer periods. Loam textures generally have the largest available water capacity, while sand on the one extreme has a small available water capacity, as does clay at the other (Figure 6).

Available water capacity coupled with soil depth determines the volume of water usable by plants at a particular site. This is illustrated by comparing relevant characteristics and consequent amounts of available water for two soils on which tea is grown, one at Timbilil in Kenya, the other at Marikitanda in Tanzania (Table 5).

Flood flows in streams and rivers, which rise quickly after heavy rainfall derive mostly from rapid overland flow of water. Flood flows are often muddy with eroded materials. Clear streamflow originates from rainwater, which has infiltrated the soil and percolated through pores of a range of sizes at different slower speeds (Figure 7).

The Plates 19–22 show streamflow during the rains from a cultivated catchment without any effective conservation measures (Plate 19) and a nearby forested catchment (Plate 20), both on the slopes of the same mountain, within 1 km of each other. The clear water, which runs throughout the year, more voluminous in the rainy than in the dry season, has percolated through the litter of fallen leaves and branches on the forest floor, which both protects the surface from rainfall impact and nourishes the soil organisms that maintain soil porosity. This water has travelled the slow route down through the soil to the groundwater, which moves into the stream via springs and seepages along the streambanks.

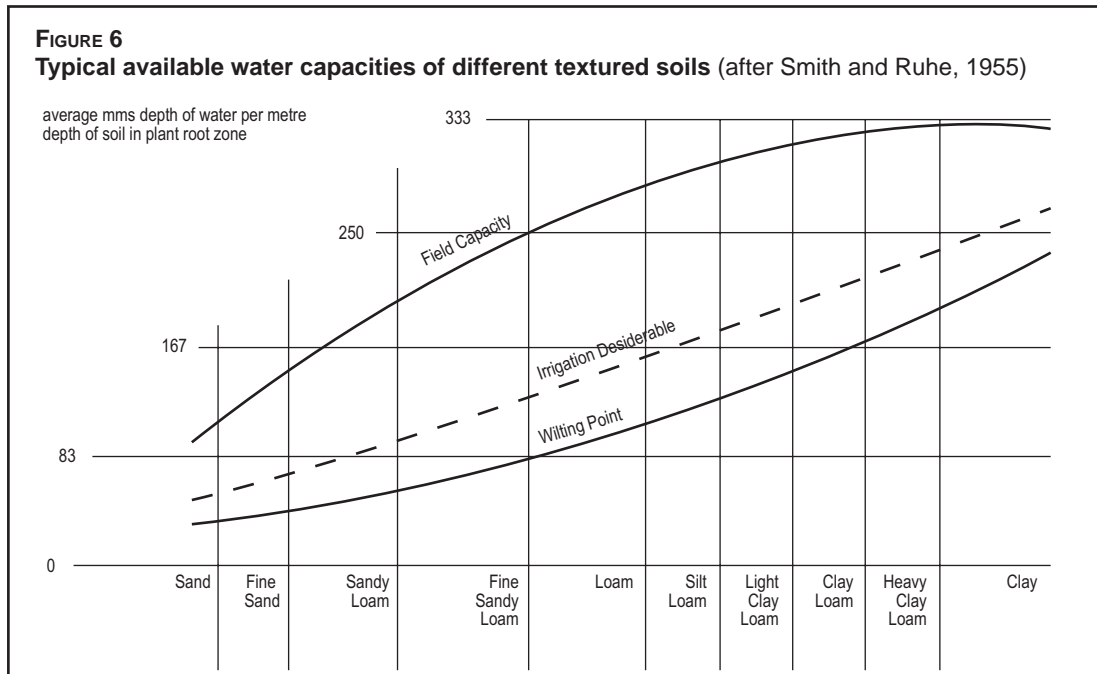

**TABLE 5**  
**Differences in available water capacities between two East African soils** (Tea Research Institute of East Africa, 1973)

	Soil depth (cm)	Bulk density (g/cc)	Total pore space (% volume)	Depth of water held at FC (mm)	Depth of water held at PWP (mm)	Water available to plants (mm)
Timbilil (Kenya)	300	0.95	64	1 632	1 001	631
Marikitanda (Tanzania)	210	1.46	45	616	384	232

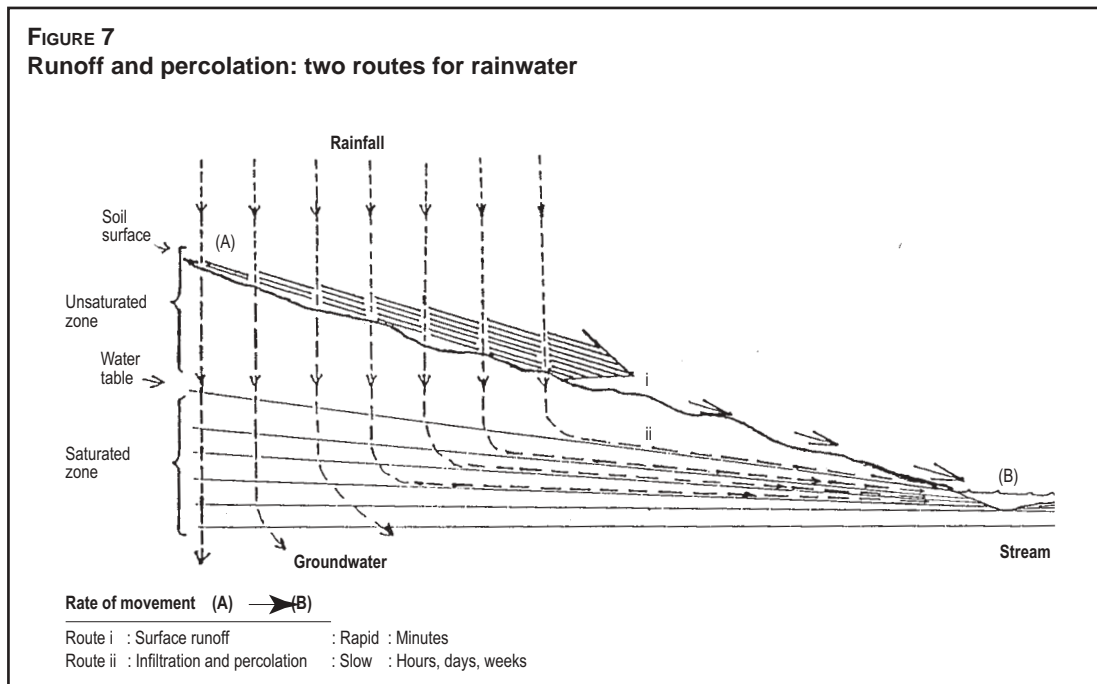





**PLATE 16**  
**Mulching within a microcatchment. Mauá, Brazil**  
 [T.F. Shaxson]



**PLATE 17**  
**The soil's water absorbing capacity in this *Eucalyptus* plantation is protected by the litter of leaves and twigs, and little runoff is likely to occur. Tupanssi, Brazil**  
 [T.F. Shaxson]

**PLATE 18**  
**Much rainfall is likely to runoff this unprotected and probably compacted, bare surface beneath trees of the same genus (*Eucalyptus*) as in the previous photo; little rainwater will be able to infiltrate and soil moisture will be scarce. Potosí, Bolivia**  
 [T.F. Shaxson]



**PLATE 19**  
**Runoff and soil loss immediately after a rainstorm, Naisi catchment. Zomba Mountain, Malawi**  
 [T.F. Shaxson]



**PLATE 20**  
**Clear streamflow from the Mlunguzi**  
**catchment. Zomba Mountain, Malawi**  
*[T.F. Shaxson]*



**PLATE 21**  
**Detention of sediment-laden runoff by**  
**a dam wall has been used to provide**  
**limited areas of flat cropland (here under**  
**rice); this may have been one of the**  
**purposes of the dam. Sharam, India**  
*[T.F. Shaxson]*

**PLATE 22**  
**The catchment for a dam is in good**  
**condition: Clean runoff can be stored**  
**for many purposes. Sharam, India**  
*[T.F. Shaxson]*



As dug wells provide direct access to shallow groundwater, on which many rural communities rely, it is important that enough rainwater penetrates and pass through the soil to replenish groundwater (Plates 23 and 24).

Exceptional rainfall such as during typhoons or hurricanes on already saturated soil can result in floods and erosion that change the landscape, no matter how well the land and the crops, grassland or forest are managed (Hamilton, 1986).

### **SOIL ARCHITECTURE AND THE IMPORTANCE OF PORE SPACES IN SOILS**

Although we generally think of soil in terms of its solid parts, i.e. the sand, silt, clay and organic matter, it is the spaces between these solid particles that are as important as the solid particles. This is because it is the spaces where all the action takes place, just as in a house, where all the important activities occur in the rooms rather than in the walls and floors. It is therefore the



**PLATE 23**  
Dug wells such as this one may go dry because the water table falls below the depth to which the well was dug. Palampur, India  
[T.F. Shaxson]

architecture of the soil that is important. The pore spaces in a soil vary in abundance according to the type of soil and how it has been managed. Soils under natural vegetation generally exhibit high porosity because of high biological activity and lack of interference by man. Consequently they have superior physical qualities compared with most soils used for crops or grazing. Plate 25 illustrates the contrasting porosity in forest and cultivated soils.

Pore spaces in soils vary in size, and both the size and continuity of pores have an important influence on the types of activities that occur in soil pores. Table 6 shows the functions of pores of different size ranges, and their names, together with the size of crop roots.

Pore sizes from 0.0002 to 0.05 mm diameter retain water that can be absorbed by crops and are referred to as storage pores, whereas smaller pores (the residual pores) hold water too tightly for plants to be able to extract it. Pores larger than about 0.05 mm diameter, referred to as transmission pores, allow water to drain through the soil and enable air to enter the pores as the water drains out.



**PLATE 24**  
Shortage of water puts extra burdens of time and effort on people. Palampur, India  
[T.F. Shaxson]

**TABLE 6**  
Functions and sizes of soil pores (Hamblin, 1985)

Pores size (mm diameter)	Description of pores	Functions of pores
< 0.0002	Residual	Retain water that plants cannot use
0.0002–0.05	Storage	Retain water that plants can use [PWP = 0.0002 mm; FC = 0.05 mm; but FC can vary from 0.03 to 0.1 mm diam. equivalent to 10 to 33 kPa]
> 0.05	Transmission	Allow water to drain out and air to enter
> 0.1 to 0.3	Rooting	Allow crop roots to penetrate freely. [Root sizes: seminal roots of cereals > 0.1 mm; tap-roots of non-cereals (dicots) > 0.3 mm; root hairs 0.005 to 0.01 mm]
0.5–3.5	Worm holes	Allow water to drain out and air to enter
2–50	Ant nests and channels	Allow water to drain out and air to enter



**PLATE 25**

**Contrasting porosity, compaction and organic matter content between the topsoil (0-20 cm) of a forest soil (on the right) and from the same soil type, immediately adjoining the forest site, after 4 years cultivation (on the left). Saaverda, Bolivia**

[R.G. Barber]



Pore spaces are also needed for roots to freely penetrate soils in order to take up nutrients and water. The sizes of roots vary with the type of crop, but the smallest roots, apart from root hairs, have diameters of 0.1 to 0.3 mm and so soils must have pore spaces of at least this size if the smaller roots are to penetrate freely. In most soils roots grow partly through existing pores, the transmission pores, and partly by moving aside soil particles. Roots can only force their way into smaller pores if the soils are sufficiently compressible; the compressibility of soils increases with increasing water content, since water provides a form of lubrication between soil particles.

### SOIL WATER MOVEMENT

The amount of water present in a soil, which is available for crop production, will depend on how much of the rainwater remains in the soil after the losses by runoff, evaporation, and deep drainage. The amount of rainfall that reaches the groundwater and thus contributes to water security, will depend on the extent to which the rainfall infiltrating the soil is in excess of that needed to replenish the soil's water holding capacity and satisfy the transpiration needs of the crops. Good rainwater management aims to maximize the amount of rainwater that enters the soil, and to make best use of it while it is there for use by crops and for recharging the groundwater. Any truly unavoidable surface runoff is conducted away safely in such a manner that it does not cause erosion problems.

When a well drained soil is saturated to the limit of its rooting zone, the rainwater that does not drain out of the root zone within 48 hours will be retained in soil pores smaller than about 0.05 mm diameter (the critical pore size may vary from 0.03 to 0.1 mm diameter). The quantity of water retained after 48 hours corresponds to the soil's field capacity (FC). The forces (or suctions) with which this water is held will vary according to pore size. The largest pores still to retain water will hold the water at about a tenth to a third of the pressure of the atmosphere (or 0.1 to 0.33 bar<sup>1</sup>), depending on what suction corresponds to the soil's FC; this will vary with soil type and depth of the water table.

The maximum suction most crops can exert to withdraw water from soil varies with the crop, but the generally accepted value is equivalent to about 15 times the pressure of the atmosphere (i.e. 1.5 Mpa). This is approximately equivalent to the pressure that would be experienced when supporting a tonne weight on the palm of the hand. When soil water has been exhausted down to 15 bars, the water remaining in the soil will be that stored in pores smaller than 0.0002 mm

<sup>1</sup> 1 bar = 100 kPa = 0.987 atmospheres = 1 020 cm head of water.

diameter, and will correspond to the soil's PWP. Water held at suctions greater than the PWP is not available for plant growth. Consequently, it is water held between FC and PWP which can be used by crops for transpiration, and is termed the soil's Available Water Capacity (AWC). However, after a heavy rainstorm some of the water in excess of the soil's FC may be used by a crop while this excess water is percolating through the rooting zone.

The available water held within the range FC to PWP is retained with different strength, and about a third of it is not easily or rapidly available to crops, especially if the crops are transpiring strongly. The higher the transpiration demand, the more available (i.e. the less strongly held) the soil water must be to avoid crop water stress. In contrast, for a slowly transpiring crop even water held at higher suctions can be used without causing stress.

The maximum amount of available water that a soil can retain (i.e. the available water capacity) will vary with the soil's texture, organic matter content, rooting depth and structure. Soil organic matter is particularly important in that it can retain about 20 times its weight of water. Organic soils and medium textured loamy soils with high contents of very fine sand and silt generally have the highest AWCs, clayey soils intermediate values, and soils with high contents of coarse sand the lowest AWCs. The stone content of soils can also be very important depending on the nature and abundance of the stones. Some ironstone gravel > 2 mm diameter can contain more than 20 percent water ( $\text{m}^3/\text{m}^3$ ) at FC and porous limestone and chalk can also make significant contributions to the AWC of a soil. In contrast, a high content of non-porous stones will greatly diminish the AWC of a soil.

For any given soil, the greater the rooting depth, the larger will be the quantity of soil water available to the crop. This is particularly important for annual crops as they have less time to develop deep and extensive rooting systems than perennial crops. The available water capacity may influence the length of growing period for crops grown on that soil. Soils of high available water capacity will permit longer growing periods because of their ability to provide greater quantities of stored water during dry periods than soils of low available water capacity (FAO, 1995a). Shallow soils have little available water, and even in wet years they will be unable to benefit by storing any more water.

### **Infiltration of rainwater into soil**

In most areas where water shortages occur, maximizing the infiltration of rainfall into soil is indispensable to achieving food and water security. Land management should encourage infiltration as opposed to runoff. Exceptions are where rainwater harvesting is necessary for crop production and where high infiltration can lead to risks of landslides or other forms of mass movement.

The amount of rainfall that infiltrates will be governed by the intensity of the rainstorm in relation to the soil's infiltration rate. Excessive tillage and loss of soil organic matter often result in reduced infiltration rate due to loss of surface porosity. When storm intensity is greater than soil infiltration rate, runoff will occur, resulting in a waste of water that should have been used for crop production and for recharging the groundwater. The rate at which rainfall infiltrates into soil is influenced by the abundance, stability and size of the pores at the soil surface, their water content and by the continuity of the transmission pores into the rooting zone. In many soils the number of surface pores is rapidly reduced by the impact of raindrops, which break surface soil aggregates into small particles that clog surface pores and form surface seals or crusts with very few pores. The destructive raindrop action is avoided where there is a protective cover of crop foliage, residues, mulches or even weeds at or over the soil surface.

Other factors that can reduce the number, proportion and continuity of transmission pores are traffic by machinery, humans and animals, which destroys large pores by compaction, and tillage which disrupts the continuity of transmission pores through the smearing and compression of pores during plough pan formation in the subsoil. Infiltration rates are also affected by (1) the quantity of water present in the soil at the time of the rainstorm, which will depend on when the last rainstorm occurred and the permeability of the soil, and (2) the soil's capacity to retain water, which will vary with soil depth, stoniness, and texture.

### **Percolation of rainwater through soil**

When a heavy rainstorm falls on a well-structured soil, rainwater percolates down through the dry soil as a wetting front, temporarily saturating the soil and displacing air. This is accompanied by the rapid drainage of water from the larger pores (greater than 0.05 mm) through gravity and the pressure of the mass of rainwater above. These larger pores exert only small forces of attraction on soil water. After about two days of drainage field capacity will have been attained and air will have re-entered the larger pores.

In poorly structured soils, rainwater will drain much more slowly. Drainage often continues for several weeks depending on the depth to the slowest horizon and the continuity of the larger pores with depth. In fine textured soils with cracks drainage water will flow down through the cracks in heavy rainstorms before the soil is saturated and while parts of the soil profile may still be dry. If the drainage water subsequently enters a smaller pore while passing through the soil, it will be retained, otherwise it will continue until it reaches the water table and contributes to the recharge of groundwater.

Once the drainage water has been lost from the rooting zone, further water movement within the root zone is slow and is referred to as capillary movement. This movement is caused by forces of attraction, known as surface tension forces, which are exerted by soil particles on water. This movement can occur in any direction and includes the upward movement of water from water tables. Surface tension forces pull water into pores within the soil and the smaller the pores the more strongly the water is attracted and held.

### **Loss of water vapour from soils**

Water is also able to move through soils as water vapour. The most important example of this is the loss of water vapour by evaporation from soil surfaces. This occurs when the concentration of water vapour in the soil close to the surface is higher than that in the atmosphere immediately above. Water vapour will then move from the soil into the atmosphere. The drier and hotter the atmosphere compared with the surface soil, the greater will be the rate of evaporation from the soil, provided sufficient water can be supplied to the surface by capillary movement from below. Fine textured soils have an abundance of small pores and so more capillary movement of water to the surface will generally occur in fine textured than in coarse textured soils.

### **Water movements into and through a plant**

Crops use large quantities of water, which under rainfed conditions come entirely from water in the soil, which in turn is derived from rainfall that has infiltrated the soil. A maize crop may use 400 to 750 mm of water depending on the rainfall and evaporation conditions. This corresponds to 4 000 to 7 500 cubic metres of water per hectare over the growing season.

Almost all the water absorbed from the soil by crop roots passes up through the stem into the leaves, where it evaporates and passes into the atmosphere in a process known as transpiration. This process accounts for almost all of the water absorbed by plant roots (about 99 percent, the remaining 1 percent being used directly in cell processes). Transpiration is essentially the same as the process of evaporation. Evaporation is what happens when a bowl of water is left in the sun. The liquid water disappears as it becomes converted into water vapour, and the higher the temperature, the drier the air, and the greater the wind speed, the greater will be the rate of evaporation. Evaporation occurs whenever water is exposed to the atmosphere, i.e. from lakes, rivers and puddles, and from the raindrops that accumulate on a leaf after a rainstorm.

To ensure an efficient uptake of sufficient water by crops it is important that the crop roots are well distributed and able to penetrate deeply into the soil. As a soil dries out from the surface downwards, so roots in the deeper layers tend to increase in number to compensate. When soil water reaches the surface of a root or root hair, it moves across the root into the xylem, which contains narrow tubes running through the root and extending up through the stems into the leaves. On reaching the leaves, water passes from the xylem into leaf cells where it evaporates into air spaces within the leaf. These air spaces are saturated with water vapour, and are connected to the normally drier outside air by very small openings in the leaves called stomata. During the day the stomata open, which allows carbon dioxide to enter the leaf. Sunlight is used to make sugars within the plant: a process known as photosynthesis. Part of the sugars are used to produce energy by a process called respiration, part are converted into substances forming the various plant organs.

Photosynthesis occurs only during daylight, whereas respiration occurs all the time. When the stomata open to allow carbon dioxide to enter, water vapour escapes into the drier air outside. For transpiration to occur there must be a continuous supply and movement of water from the soil to the plant to the atmosphere. The driving force responsible for this movement is the same as for evaporation, and can be simply described as the tendency for water to move, either as a liquid or a vapour, from where it is more abundant to where it is less abundant. In transpiration, water vapour moves from the very humid (i.e. high water vapour content) air spaces within the leaf into the drier atmosphere outside the leaf where the water vapour concentration is lower.

The movement of water vapour out of the leaf creates a suction (or “pull”) on the water in the leaf cells, the xylem, the roots and the soil, so water moves into the root, up the xylem and into the leaves, to replace that which has been lost from the leaves. In addition to the transpirational suction, which causes water to move from the soil into the root, there is another force attracting water into the root known as osmosis. In osmosis, water moves from where it is more pure to where it is less pure across a semi-permeable membrane. A semi-permeable membrane is a very thin skin, which has pores large enough for water to pass through into the root but not large enough for dissolved salts to pass out of the root.

Water therefore passes from the soil where the water is more pure (i.e. contains few dissolved salts) across the root surface (a semi-permeable membrane) into the root where the water is less pure (i.e. contains more dissolved salts).

### **Water stress – nutrient interactions**

Many areas with low and erratic rainfall where crop water stress is common are also deficient in nutrients, and the lack of nutrients is frequently the second most limiting soil factor. An interaction often occurs between soil water and nutrients, which means that soil water can

influence the availability of nutrients, and the availability of nutrients can influence the uptake of soil water and a crop's resistance to drought. Thus, both factors can influence each other.

Plants contain a certain amount of water within them, which acts as a buffer against times of water shortage, but the amount is too small to last long. In contrast, plants store sufficient quantities of nutrients within their tissues to provide a buffer for longer periods when nutrients are not being absorbed. Consequently, water deficiencies become more quickly apparent and damaging than nutrient shortages. This suggests that conserving water may often be of prior and quicker benefit than attempting to conserve soil particles *per se*.

In addition, a lack of water also reduces the uptake of nutrients by a crop. This is largely because nutrients can only move to roots through water films within the soil, and so there must be continuous water films connecting the nutrients with the roots. A lack of soil water continuity, due to drought for example, will severely reduce the rate of nutrient uptake by crops.

A lack of soil water will also diminish nutrient availability by reducing microbial activity, which is responsible for the liberation of nitrogen, phosphorus and sulphur from soil organic matter.

When there is a drought it is the surface soil, (which generally contains the bulk of the plants' roots and the soil's nutrients) which dries out first, and so while a crop may still be able to absorb water from the subsoil, it may suffer from a lack of nutrients.

A lack of available nutrients in the soil can restrict crop water uptake, especially when nutrients are limiting root development. This occurs most often in soils that are deficient in phosphorus. Applying P fertilizer to P-deficient soils will often promote root development, and as a result crop water uptake. Consequently the beneficial effects of applying P fertilizers are often relatively greater in seasons of lower rainfall than in those of higher rainfall.

The effects of drought and nutrient availability on crop yields are difficult to predict, because the effect will depend on when the water or nutrient shortage occurs in relation to the crop's stage of growth, and its needs and sensitivity to a lack of water or nutrients at that time. It is therefore often difficult to assess which factor, e.g. water or nutrients, is the more limiting to yield. The most limiting factor can vary from season to season depending, for example, on when water shortages occur, and even during a season there will probably be periods when water is the main limiting factor, and other periods when nutrients are most limiting.

Water shortages often affect whether or not there is a response to fertilizers, and how much fertilizer should be applied. This is particularly common with N fertilizer, where the optimum response is frequently higher in good seasons than in poor seasons. For example, when there is no shortage of soil water an application of 40 kg/ha may prove to be the optimum application rate, but when water is lacking only 20 kg/ha may be the optimum amount to apply.

This creates difficulties in rainfed agriculture: since it is not possible to reliably predict the distribution and amount of rainfall, farmers cannot know how much fertilizer to apply. One approach that can help to overcome this problem is to apply a modest amount of N fertilizer at the beginning of the season assuming low rainfall, and then to apply additional quantities N later if the season appears promising.

### **Causes of restricted rooting**

The most common cause of restricted rooting is physical restriction due to soil compaction, which results in the collapse or diminution of pore spaces and a localized increase in bulk





**PLATE 26**  
**The beginnings of a plough pan formed**  
**on a sandy clay loam after 8 years of disc**  
**ploughing and harrowing. Ibamirapinta,**  
**Camiri, Bolivia**  
*[R.G. Barber]*

density. Once pores have been compacted to less than about 0.2-0.3 mm diameter, it is difficult for crop roots to freely penetrate the soil. Although the strength of compacted layers decreases as soil water content increases, a high water content can quickly limit the supply of oxygen to roots, so that roots then become restricted by a lack of oxygen. Certain crops, such as cotton and sunflower, appear to be more susceptible to restricted rooting from compacted layers than others. Compaction often reduces pore sizes sufficiently to inhibit root penetration but not sufficiently to affect the drainage of water through the soil. Pores of 0.2-0.3 mm diameter can restrict roots but water can drain under gravity through pores as small as 0.01 mm diameter (Russell, 1973).

In mechanized cropping systems the continual use of tillage implements, especially disc ploughs, disc harrows, mould-board ploughs and rotovators, over long periods of time frequently results in the formation of dense plough pans containing few pores large enough to be penetrated by crop roots (Plate 26). The plough pans develop just below the depth to which the soil is tilled and often have smooth upper surfaces with sealed pores, caused by the smearing action of mould-board ploughs. The degree of compaction depends on the pressure exerted by the implements on the soil.

Land preparation when soils are wetter than the optimum moisture content for tillage promotes soil compaction, because the soils are then much more compressible. This is particularly likely to occur on soils that have deficient drainage, or are difficult to till in a dry state without pulverizing because of their very hard consistence (e.g. hardsetting soils). Compaction is also more likely when farmers use many passes to prepare the seed bed, or when they have only limited tractor power available and are unable to use wide sets of equipment and therefore produce compacted wheel ruts at closer spacing across the field surface. Compaction can also develop in the subsoil from the passage of heavy

**FIGURE 8**  
**Sideways development of tap-root of a wild okra weed**  
**growing in a maize field; the change in growth habit of**  
**the root is caused by a compacted hoe pan at the base**  
**of the ridges formed by hoeing to the same depth**  
**(and the passage of feet during the rains) over many**  
**years (Adapted from a picture of G. Evers)**

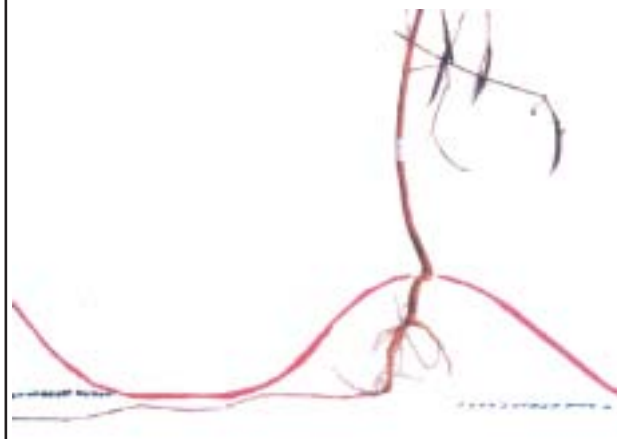

**PLATE 27**

**Heavy rain two weeks after sowing caused this unstable sandy soil to slump and develop a dense layer, which inhibited the growth of young soybean roots. Las Brechas, Santa Cruz, Bolivia.**

[R.G. Barber]



machinery such as combine harvesters and lorries loaded with grain, especially in wet conditions. The degree of compaction will depend on the total axle load of the machinery.

Soil compaction can also develop from hand tillage. Thin hoe pans just 2-3 cm thick can develop just below the depth of hoe penetration and thus restrict root penetration (Figure 8). When mounds or ridges are formed every year, the combination of hoeing at the same depth and the traffic of people within the furrows during wet conditions may accentuate the compaction.

A similar effect to that of compaction can occur when structurally unstable soils, known as hardsetting soils, slump on becoming saturated by intense rainstorms to form dense layers. On drying the dense soil layer becomes very hard and restricts root penetration (Plate 27).

Restricted rooting may also be caused by naturally occurring dense horizons containing few pores large enough for roots to penetrate. These horizons may be found in soils formed from river, lake or volcanic sediments and in semiarid and arid areas where chemically cemented calcrete and gypsic horizons are formed.

In some situations root restriction can be caused by a seasonally fluctuating water table. During the rainy season the crop roots are confined to a shallow zone immediately above the high water table. If, when the water table falls during the dry season the crop roots have already completed their development, the roots will remain where they were, close to the surface, and without access to available water in the deeper subsoil. Roots may also be restricted to shallow depths by chemical factors, such as the presence of toxic aluminium or manganese, or by severe nutrient deficiencies in the subsoil. Problems of water stress may be the result of restricted rooting combined with various other factors as illustrated in Box 1 (Barber, 1995).

### Indicators of restricted rooting

The most obvious indicator of restricted rooting when a crop is present is the distribution of the

#### **Box 1: THE CAUSES OF INCREASED WATER STRESS IN THE SANDY SOILS OF EASTERN BOLIVIA**

In the lowlands of Santa Cruz in eastern Bolivia about half of the soils in the central zone are seriously compacted, and suffer from restricted rooting and low porosity. They are predominantly sandy soils that have become very prone to crusting and wind erosion. Consequently they have become increasingly susceptible to water stress because of the combined effects of:

- restricted rooting due to compaction caused by disc ploughing and hardsetting;
- reduced rainfall infiltration due to surface crusting;
- a decreased supply of soil water available for crop growth due to:
  - loss of water-storage pores due to compaction and hardsetting;
  - incorporation of fine-sandy deposits due to wind erosion;
  - accelerated loss of organic matter due to excessive tillage.
- increasingly erratic rainfall and greater incidence of droughts.



crop roots. When roots are physically restricted by a dense layer containing few pores suitable for root penetration, individual roots often develop characteristic growth patterns immediately above the restricting layer as shown in Figure 9. The most common of these is the abrupt change in the direction of growth from vertical to horizontal, and a thickening of roots that do manage to penetrate the restricting layer just above the upper boundary of that layer.

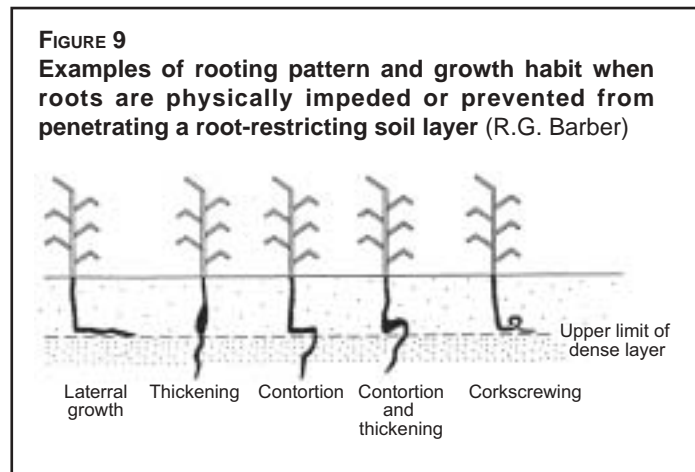

In mechanized agriculture, plough pans are usually formed at 12-30 cm depth, depending on the implement used and its normal working depth. Naturally occurring dense layers may occur at any depth. The optimum time to observe roots is after flowering when most of the roots will have largely completed their growth.

When no crop is present, it is much more difficult to identify the existence of potentially root-restricting layers in a soil. However, the rooting pattern of mature weeds, either rooted or uprooted, that remain in the field after the crop has been harvested can be used to reveal the existence of a root-restricting layer.

When neither a crop nor weeds are present, the presence of a dense soil layer of high strength and containing very few visible pores will often be a useful indicator. The presence of dense layers is often revealed when digging by the abrupt increase in resistance to the spade or hoe when the restricting layer is reached. However, sudden increases in soil resistance can also be experienced when the soil changes from moist to dry. To avoid this problem, it is advisable to wet the soil to 30 cm depth two days prior to carrying out the field examination.

Physically restricting layers can be identified by the scarcity of visible pores. The smallest pore visible to the naked eye (0.1 mm diameter) coincides reasonably well with the smallest pores into which the seminal roots of cereals (0.1 to 1 mm) and the tap-roots of dicotyledons (0.3 to 10 mm) can penetrate. When the density of visible pores observed in fragments of the dense layer from a soil pit is less than about six in an area of 10 cm x 10 cm, root restriction is likely to be severe, and responses to breaking up the restricting layer are likely. Other indicators of potentially root-restricting layers that can be used in the field in the absence of a crop are soil strength determined with a penetrometer, and soil bulk density determined from undisturbed soil samples of a known volume. Critical penetrometer resistance and bulk density values at which the roots of most annual crops are restricted have been established for soils of different textures.

## Chapter 3

# Rainwater, land productivity and drought

### RAINWATER FOR IMPROVING YIELDS

Much of the future food needed by the increasing numbers of people in developing countries will have to come from rainfed rather than irrigated lands, because the possibilities for increasing the area under irrigation are limited. Subhumid to semiarid areas are characterized by rainless periods, both within and between rainy seasons, which are generally unpredictable. Because of this the output of crops, pastures and streamflow is affected not only by the total amount of rainfall in a particular season, but also by the frequency, duration and severity of water stress in the plants at different stages of growth.

Greater attention to the value, capture and use of rainwater in increasing production from rainfed lands in the tropics and subtropics is justified on two main counts:

- Increasing numbers of the rural poor live in areas where they must depend on rainfall alone for both crop production and domestic water needs.
- Since yields of crops in small farmers' fields are on average far below those possible on well-managed plots on experimental stations even modest actual increases in production are probably achievable, whereas proportionately larger increases from irrigated areas seem unlikely to be achieved.

Soil productivity should be maintained and improved overtime. Two features are fundamental, for without them plant growth will be limited and the productivity of soils will not be sustainable:

- Sufficient soil water, in optimum proportions with pore space and solids, and of sufficiently long persistence at plant-available tensions, is vital for plants to complete their full sequence of growth.
- For damaged soils, achieving and maintaining optimum porosity, plus raising and maintaining biological self-recuperation capacity, are effective ways of improving crop production where rainwater is a limiting factor (Shaxson, 1993).

Successful water management in a dryland farming system is based on: (1) retaining precipitation on the land; (2) reducing evaporation; (3) utilizing crops that have drought tolerance and fit rainfall patterns (Stewart, 1985). This raises three questions:

- Can water get into the soil fast enough to avoid runoff?
- Is the soil in a condition to allow water uptake through plants without their suffering damaging water stress in their tissues and to allow downwards transmission of excess to the groundwater?
- How is it possible to raise people's skills in soil and crop management to close the yield gaps between research-station experience and in-field practice?

To effectively address the rising concerns about the land's capacity to produce crops and sustain streamflow, it is no longer sufficient to consider macroscopic factors alone. A

framework for action must be based on understanding at microlevel as well. This will include understanding of how plants and soils function together and how they are likely to react to proposed improvements, e.g.:

- The collapse or compaction of pores of all sizes is the prime reason why water may not enter the soil and runoff can occur.
- A key factor for soil sustainability is the maintenance of biological capacity for self-recuperation and how to encourage this biological activity in the field.

More widespread understanding of such factors may lead to a greater respect for the soil as an environment for biological activity, for meso- and micro-organisms as much as for roots themselves.

### **Deteriorating water supply**

A deterioration of water supplies refers to diminished quantities of groundwater and surface water as well as to deteriorating water quality. Poor quality water may be the result not only of inappropriate land use and soil management practices which result in materials being transported by surface runoff, but also of industrial and urban pollution due to inadequate processing controls and poor sanitation.

Increased runoff at the expense of rainfall infiltration is a major cause of declining groundwater, as less water is then available to percolate through the soil down to the groundwater, i.e. less recharge occurs. Increased runoff is often the result of changes in land use that reduce the protective ground cover and decrease surface soil porosity, as for example when forest vegetation is converted into inadequately-managed annual cropping. Such land use changes often arise when rising population pressures force people to cultivate or graze land that is poorly suited to the use to which it is being put.

Changes in land use that increase the quantity of water used in transpiration, such as reforestation programmes, will be expected to diminish the frequency and amount of groundwater recharge, assuming no changes in the amount of rainwater lost by runoff or other processes. Conversely, deforestation followed by the cultivation of annual crops would be expected to decrease transpiration and so increase groundwater supplies, as long as no extra runoff occurs as a result.

Drainage of swampy areas in middle and upper watershed positions can also reduce the amount of water reaching the groundwater through deep drainage due to the diversion of water into drainage canals. Falling groundwater levels may arise as a result of increased water consumption by irrigation schemes. The lack of proper drainage in irrigation schemes may lead to deteriorating groundwater quality due to the accumulation of salts.

Greater runoff can also result from urbanization because of the replacement of agricultural land by extensive areas of tarmac and concrete, such as roads, pavements and buildings. These prevent water infiltration and generate high proportions of runoff. In many developing countries, as populations grow and industrialization and urbanization increase, the demand for water grows and eventually exceeds the quantities available. San Salvador for example, has suffered serious water shortages due to various factors, including increased urbanization and industrialization (PRISMA, 1995; Barry and Rosa, 1995).

Throughout the world's continents water tables are falling, and it has been estimated that by 2025 more than half the world's population will be living in regions suffering from a shortage

of water (Rockstrom, 1999). The combination of falling groundwater and greater runoff will reduce the base flows of rivers and streams, and will greatly increase peak flows and the incidence of floods. High runoff often affects the quality of surface water by its load of eroded soil sediments, may make the water unsuitable for drinking, and may increase the costs of water treatment. High sediment loads in the reservoirs of hydroelectric schemes will reduce the life span of dam sites and increase turbine maintenance costs.

The recommended amount of water needed for one person per day for cooking, drinking and washing is about 50 litres, but the amount of water needed every day for a crop to transpire and produce sufficient grain for one person is some 10 to 20 times larger. Therefore, water shortages will have most effect on food production, rather than on the availability of water for domestic use.

### **Indicators of deteriorating water supply**

The following are simple visual indicators of deteriorating quantity and quality of water supplies (FAO, 2000a).

Indicators of the lowering of groundwater tables from 1 year to another:

- drying of wells
- drying of springs
- extending the depth of boreholes
- dying trees at river margins

Indicators of reduced surface water:

- diminished base flows in rivers
- increased deposition of sediments in river beds
- more meandering streamflows in river beds
- greater frequency and severity of flooding
- greater deposition of large rocks and boulders

Indicators of reduced quality of surface water:

- pollution and discolouration of water by sediment
- algae
- bad smells

Indicators of reduced quality of groundwater:

- high salt contents
- bad smells
- algae

### **SOIL PRODUCTIVITY AND SOIL EROSION**

Increased possibilities for safe and sustainable intensification of production can be identified if the nature of soil productivity and the process and the effects of soil erosion are examined.

#### **Soil productivity**

Fertility is the inherent capacity of a soil to supply nutrients in adequate amounts and suitable proportions, whereas soil productivity is a wider term referring to the ability of a soil to yield



**PLATE 28**  
**Root systems exposed at a roadside cutting (Burgay, Ecuador)**  
*[T.F. Shaxson]*

crops (Brady, 1974). The chief factors in soil productivity are soil organic matter (including microbial biomass), soil texture, structure, depth, nutrient content, water-storage capacity, reaction and absence of toxic elements. A brief description would indicate that soil productivity depends on physical, hydric, chemical and biologic characteristics and their interaction.

Much can be known about the above-ground growth and development of plants by observing and measuring them and their functions. We know much less of what goes on beneath the surface in the soil ecosystem, where plants' roots are important constituents. In order to function unimpeded through cycles of growth to maturity, land plants require water to pass through them from soil to atmosphere.

Plate 28 shows the length of roots relative to the above-ground parts. The smaller roots and their root hairs also constitute a large part of any root system, but are not easily visible.

Root systems are of astonishing dimensions, as illustrated by comparative figures from the same-sized samples of soil (Table 7). In favourable conditions, roots of some plant species may grow by as much as 10 mm/day.

The relative proportions of solids, liquid and gases in the rooting environment are as important as the manner in which they are arranged. In this respect, the biotic content of soil is also important because together with plant roots it contributes to restructuring soil and the improvement of porosity after damage by compaction, pulverization or structural collapse.

Without good conditions for roots very high-yielding crops will be unable to express their full potentials. The key role of soil porosity is shown in Figure 10.

Many degraded soil situations have arisen because of mould-board or disk plough-based farming practices, which have resulted in:

- decline in soil organic matter
- compaction of the soil causing reduced porosity

**TABLE 7**  
**Dimensions of roots of three grasses in sample of 0.688 litre taken to a depth of 15 cm (after Russell, 1961)**

	Soybean	Oats	Rye	Kentucky Bluegrass
<b>Roots</b>				
Total length	29 m	46 m	64 m	384 m
Total surface area	406 cm <sup>2</sup>	316 cm <sup>2</sup>	503 cm <sup>2</sup>	2 128 cm <sup>2</sup>
<b>Root hairs</b>				
Total number	6.1 million	6.3 million	12.5 million	51.6 million
Total lengths	0.6 km	8.1 km	16.8 km	51.7 km
Total surface area	0.03 m <sup>2</sup>	0.3 m <sup>2</sup>	0.7 m <sup>2</sup>	15.8 m <sup>2</sup>



- reduced plant-available soil moisture at critical times
- loss of soil depth

Each of these four factors negatively affects soil as a habitat for plant roots. The view that such conventional tillage methods limit the development of an optimum habitat for rooting is borne out by the experience of alternative agriculture systems.

The amount of moisture in the soil depends on how much rainfalls and enters the soil. Under rainfed agriculture, the amount of water entering the soil depends on what percentage is diverted above the surface as runoff. It may not always be possible to prevent all runoff, but improvement of soil physical conditions will help to reduce it to the unavoidable minimum.

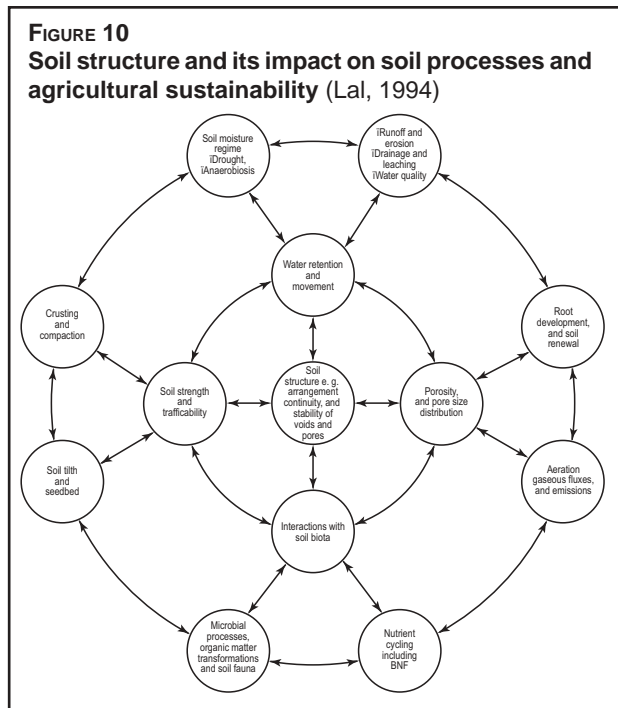

A thin surface crust or subsurface compaction can be enough to reduce the rainwater infiltration rate, to provoke runoff and to cause loss of water, soil and consequently potential soil moisture (Plates 29 and 30). However, when the soil is covered with litter, more water enters and the soil surface is protected from the force of raindrops (Figure 11).

Infiltration and availability of water to plants depends on how the water is held between, firstly, individual particles of the soil (e.g. microscopic plate-like clay particles, irregular coarse-sand particles etc.) and secondly, on the distribution of different sizes of pore space in soil. If the majority of pore spaces is very small, whether because of the inherent properties of the soil such as in a very clayey Vertisol, or because the soil has been compacted, the water may be held so tightly that plants

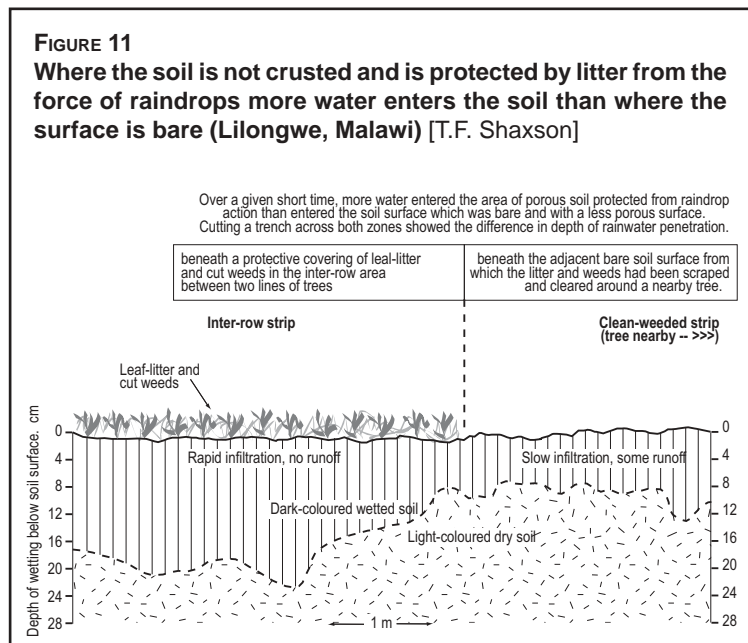

cannot extract much of it. On the other hand if the soil has a predominance of large spaces, such as in coarse-textured sandy soils, much or all of the rainfall may enter the soil and pass easily and rapidly down through the profile without much of it being retained. A wide range of pore sizes is therefore desirable for enabling both retention and transmission of rainwater.



**PLATE 29**  
**A thin surface crust caused by raindrop impact on a bare soil of poor structure (Tabatinga, Brazil)**  
*[T.F. Shaxson]*

**PLATE 30**  
**Crusting and subsurface compaction can result in serious losses of water and soil (Khotbotle, Lesotho)**  
*[T.F. Shaxson]*



**PLATE 31**  
**Roots of a cotton plant stunted and diverted sideways by a very compact subsurface layer (São Paulo, Brazil)**  
*[T. F. Shaxson]*

Reduction of pore space may be at least as important as losing soil particles with respect to yield. It affects water movement and the soil's tenacity of water retention, root expansion and gas exchange of  $O_2$  and  $CO_2$  with the atmosphere. Its loss is similar to losing spaces in a block of apartments when they are demolished: the same quantity of materials remains, but the value of the architecture is lost because there are no longer usable voids/rooms.

Field observations in Malawi, Zambia and Tanzania indicate that repeated tillage to the same depth with hand hoes can cause subsurface pans of compacted soil at the base of the tillage layer. After a few years, they may become so dense that neither roots nor water can penetrate them easily. This increases surface runoff, severely limits soil depth and causes stunting of roots (Plate 31). With root access to soil moisture restricted to the shallow soil layer above the compacted layer, plants are prone to suffer water stress after only a few days of dry weather.

Much of the blame for this damage to soils can be attributed to inappropriate tillage practices. Such problems are found not only in tropical areas but also are now widely seen as well in temperate zones across North and South America, Europe, Asia, Australia and New Zealand. In temperate zones damage is due to compaction by machines.

In tropical regions much damage is also done by high-intensity rainfall on unprotected soils.

Physical degradation of the soil is the precursor of excessive runoff, reduced soil moisture and root restriction, and is a primary limitation to crop growth. There are already widespread and serious problems in soils as rooting environments, characterized not so much by erosion as by unexpectedly poor performance of crops in large parts of the world, in both rainfed and irrigated areas.

### Soil erosion

Runoff and erosion occur because soil porosity has been damaged, whether at or below the surface of the soil. They are the consequences, not primary causes of land degradation. In many instances tillage aimed at loosening the soil to let in more rainwater can also result in soil collapse, which then leads to increased erosion and loss of potential soil moisture through runoff.

It is sometimes assumed that yield reductions following soil erosion can be directly related to the quantities of soil materials lost. This may not always be the case, for example where erosion removes a similar quantity and quality of material from three soils with different subsoils, yields may be different from each other and equal, lower or higher than before the erosion (Figure 12). Where a subsurface layer is of better quality for rooting than that which overlays it, erosion could be followed by higher, not lower, yields though such situations are not common.

The differences in yields are related to the differences in the characteristics of the subsurface habitats in which the roots will grow before and after the erosion i.e. differences in depth, organic matter content, infiltration capacity, plant nutrient supply, biotic activity and architectural stability (Plates 32 and 33).

**PLATE 32**  
Erosive loss of the pale surface soil would expose the dark soil layer whose characteristics might provide a completely different quality of potential seed bed (Thabana Morena, Lesotho)  
[T.F. Shaxson]



**PLATE 33**  
Runoff, due to damage to soil porosity, removed the topsoil and the subsoil is exposed; accumulation of fine soil fractions and organic matter at the lower margin (bottom left of the picture) is at the expense of soil depth and quality at the upper side (Iracemápolis, Brazil)  
[T.F. Shaxson]

**FIGURE 12**  
**Yield after erosion is related to the quality of soil remaining, not to quantity and quality of soil removed (Shaxson, 1997a)**

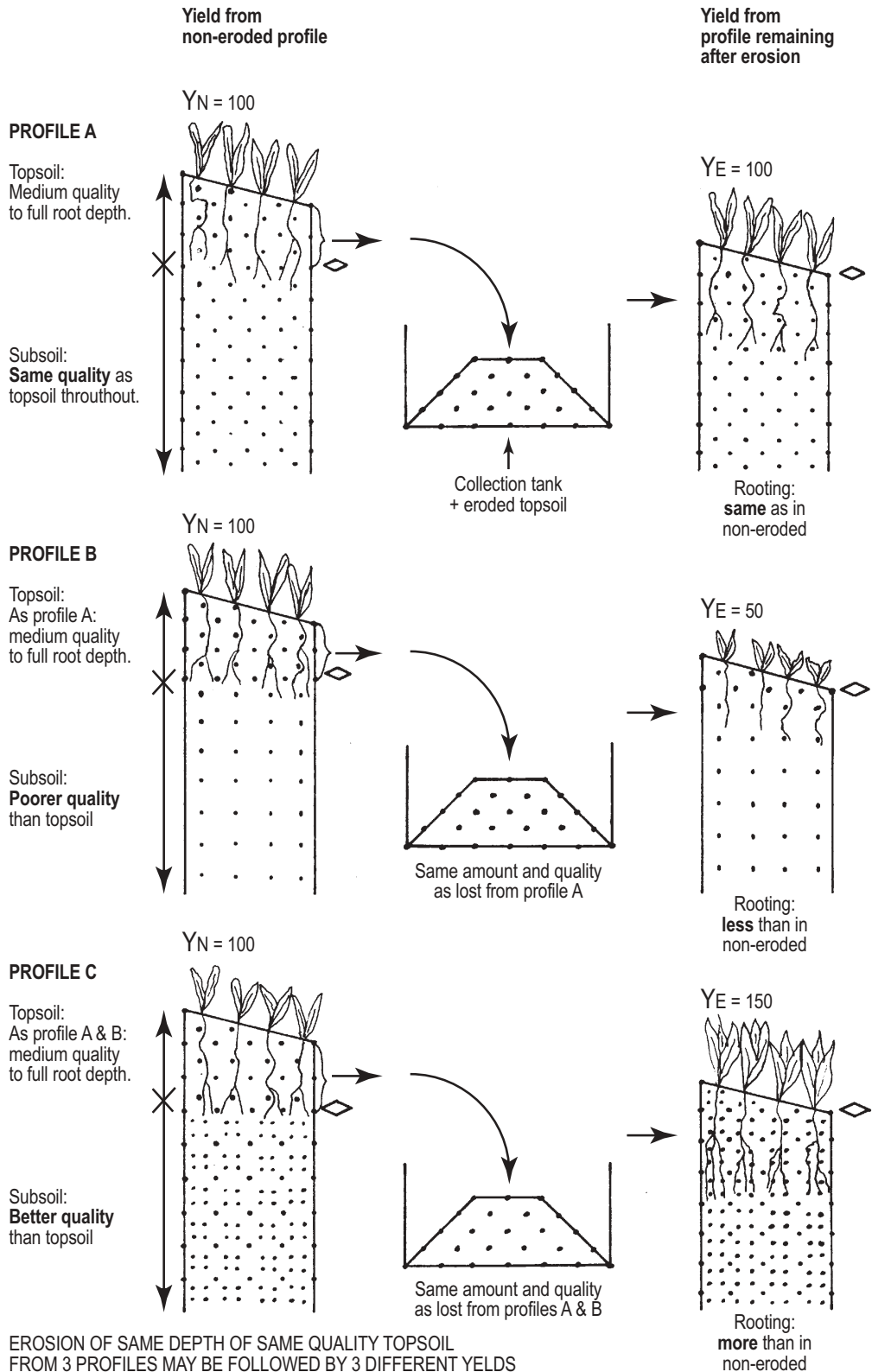



Differences in soil surface porosity affect water infiltration rates. Compaction of the soil by trampling or machinery has the same effect, changing the hydraulic conditions of the soil. Loss of porosity in the soil increases surface runoff, increasing infiltration increases soil moisture. A failure to understand this relationship has often led to inappropriate actions to stop erosion, such as construction of physical works or overuse of fertilizers (Box 2).

Conventional physical means of Soil and Water Conservation (SWC) have often proved less than satisfactory and not widely acceptable to farmers, because they tried to halt runoff and erosion rather than concentrating first on improving the absorptive capacity and productivity of the soil *in situ*, thereby minimizing runoff and erosion as a consequence. As an example Plate 34 shows a field where compaction caused by excessive disking has created a subsurface pan, which has reduced the effective depth to about 4 cm, resulting in a waste of rainwater from excessive runoff. In undisturbed conditions under native vegetation, the effective rooting depth for this soil is more than 3 metres. Breaking the pan to restore favourable conditions for rooting and water infiltration would have been more appropriate than using sandbags.

Each time erosion occurs, the rooting environment for the subsequent crop is altered. This understanding shows the need to:

- protect the soil surface from damaging forces of rain and wind;
- increase rainwater infiltration;
- encourage biological restoration of newly exposed surface layers;
- minimize desiccation, which damages both roots and micro-organisms.

#### Box 2: ADDRESSING EROSION AND LOSS OF SOIL FERTILITY IN THE PHILIPPINES

In the Philippines, investigations were made of loss of soil productivity associated with erosion. This problem is widely recognized by small farmers who have observed natural terraces forming between contoured buffer strips on agricultural land with 20-30 percent slopes. They noted that crop performance on the upslope side of these terraces was not as good as that on the lower side. To rectify this difference, they applied up to three times their usual rates of N, P and K fertilizers on the degraded upper parts of the strips between the buffers.

But even though the eroded soil had accumulated along the lower side, as in Plate 33, the yield increase owing to the fertilizers was insufficient to make up for the drop in yields averaged between those from the upper and lower halves of these terraces taken together. It was then found that placing all the residues from the previous maize crop on the upper part of the terrace significantly increased fertilizer efficiency on the degraded zones of the terrace; adding lime – to reduce the acidity of the soil – also helped to raise yields and increasing soil organic matter was recommended as a long-term measure to sustain crop yields.

This experience suggests that part of the problem was the poor physical, chemical, hydric and biological condition of the soil for rooting, which could not readily be improved until more water reached the roots and the soil quality had been improved (Stark, 2000). Comparable observations have been made in other countries, including in El Salvador

(Vieira *et al.*, 1999).

**PLATE 34**  
**Hardpan, runoff and inappropriate physical measures (Tabatinga, Brazil)**  
*[T.F. Shaxson]*





This approach is radically different from and should precede any physical measures that may still be necessary to catch and redirect runoff once it has begun. Soil characteristics, which favour water infiltration and gas exchange are the same as those that minimize runoff and erosion. In this way conservation concerns can be fully integrated with the production process.

### Plant-damaging drought

The figure for the annual average rainfall is no indicator of the frequency of drought, either between or within years, as shown in Table 8. The mean rainfall between 1956 and 1977 was 1 025 mm, but the variation was from 507 to 1 917 mm.

Drought periods within a particular year may show up as a delay in the onset of a rainy season; as dry spells of a week or more at critical periods of crop growth within the season; or as an earlier-than-expected end of the rainy season.

Unreliability of rainfall within the rainy season can be shown graphically (FAO, 1999a). Figure 13 shows an example of short-duration droughts within the monsoon season in Hyderabad (India) with serious consequences for annual crops.

**TABLE 8**  
**Annual rainfall totals at Indore, India**  
(Shaxson *et al.*, 1980)

Year	Rain mm	Year	Rain mm
1956	808	1967	964
1957	632	1968	903
1958	1 208	1969	1 054
1959	1 743	1970	910
1960	860	1971	926
1961	1 246	1972	598
1962	1 103	1973	1 917
1963	998	1974	952
1964	1 084	1975	1 209
1965	507	1976	1 221
1966	696	1977	1 025

#### **Box 3: WATER SUPPLY AND DEMAND IN PRECARIOUS BALANCE IN KARNATAKA (INDIA)**

In three watersheds, there has been a dramatic increase in groundwater extraction for irrigation during the last 10 years. This has been driven by the relatively higher profitability of irrigated agriculture when compared with rainfed agriculture. Although there may be some small areas of unexploited aquifer in two of the watersheds, the evidence points to the conclusion that current levels of groundwater extraction are approximately equal to annual recharge. Over large areas, wells are pumped for irrigation each year until they fail.

As a direct consequence of increased groundwater extraction, groundwater levels have fallen and shallow wells have failed as tube wells have been constructed and as extraction from the deep aquifer has become the norm. Falling groundwater levels have led to changes in the surface hydrology of the project watersheds. Springs and seepage zones have dried and now only flow or become saturated after exceptionally wet periods. Flow in ephemeral streams is less prolonged after large rainfall events and as a consequence flows into reservoirs are reduced.

Although runoff for individual or sequences of rainfall events is often higher than the 2 and 6 percent average annual runoff recorded from plots and fields, this finding shows that there are no large volumes of additional surface water that can be harvested in the project watersheds.

Estimates of groundwater use on a village-by-village basis show that extraction is far from uniform. Levels of groundwater extraction in some villages are more than 2.5 times higher than recharge values.

In some villages there are already problems of water shortage in the dry season. In these cases, it is the poor, particularly women and children, who suffer most. Even more worrying is the prospect of a major groundwater drought in the region. Levels of groundwater extraction are such that, in many areas, there is no longer a groundwater buffer that can be used as a source of supply during periods of meteorological drought when no recharge will take place.

The results of the study show clearly that the focus of [the project] should be on water resource management as opposed to water resource development. Water resources in the watersheds are close to being fully developed and, in general, constructing check dams or new wells will only change the pattern of water abstraction and use, but will not make additional water resources available.

A fundamental need is to consider trade-offs associated with changing patterns of water use and select options that maximize the social and economic value of water in any given setting at the watershed scale. In most cases, this means giving drinking-water the highest priority and then allocating water to uses that have the next highest social and economic value.

(Adapted from Batchelor *et al.*, 2000)

### Making droughts worse

Only rainwater that enters the soil can be effective with respect to plant growth and dry season streamflow. Avoidable surface runoff can reduce soil moisture and groundwater. Induced drought means that plants may become stressed earlier than need be, even though there is sufficient rainfall above-ground to provide for the crop.

A recent study in Karnataka, India shows that a precarious situation develops when the combined demands for soil moisture for plants and liquid water exceed average recharge of soil and groundwater (Box 3).

Areas may be increasingly desertified by land management practices, which result in soil damage (Box 4).

### Shortening the duration of drought

Climatic drought is unavoidable. Extending the period in which soil moisture remains available to plants shortens the duration of potentially damaging water stress in plants. At the same time this shortens the length of the non-producing period of the year during which the stored food will be eaten before the next harvest.

In seasonally dry regions the focus of attention should be on how much rainwater can be caught and stored in the soil much more than on emphasizing how much runoff has occurred across the land surface. Root systems are more extensive when water is not a limiting factor, as illustrated by differences in root growth by plants of the same clone of tea grown under rainfed and irrigated conditions (Figure 14). After 9 months, the root systems of one representative plant from each treatment were exposed by root washing and drawn to scale on paper. Dry periods within the 1968-1969 rainy season led to inhibition of root growth in the rainfed treatment, whereas the regular provision of sufficient irrigation water avoided water stress in the other treatment and resulted in a more profuse root system. Roots grow and extend within those volumes of soil where soil moisture is available.

This indicates that enabling more rainwater to enter the soil and minimizing losses from runoff and evaporation from the surface will be beneficial for root growth, provided that other factors such as nutrient levels and physical barriers to root growth are not limiting.

The development of a wide range of stable pore spaces cannot be achieved by mechanical tillage and can only result from soil biological activity. Soil organisms make

#### Box 4: MORE RUNOFF, MORE DROUGHT

Near Arusha in Tanzania there have always been drier and then wetter years, and the long-term average did not show a decline. But despite this people complained about worse droughts occurring. This is an increasingly common phenomenon in many parts of the world, where usually due to land mismanagement the soil surface layers become less porous, allowing smaller proportions of rainfall to infiltrate with increasing runoff. Soil moisture therefore is not replenished to the extent indicated by rainfall figures alone (Christiansson, 1988). The mean annual rainfall (500 to 800 mm) near Kondo used to support dense vegetation. The erosion has been terrible following clearing, excessive cultivation and overgrazing. The waste of potential soil moisture and groundwater over the years, more than the erosion process itself, has resulted in an impressive reduction and change of vegetation (Plate 35).

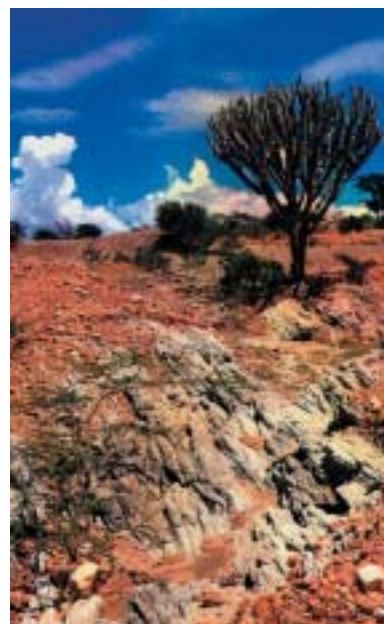

**PLATE 35**  
**Mismanagement of the forests of Ugogo (Tanzania) has led to a major reduction in vegetation density and a change towards more drought-tolerant species**  
*[C. Christiansson]*

FIGURE 13

Within-season droughts with annual rainfall totals of 1 275 mm (1915), 776 mm (1965) and 340 mm (1972) in Hyderabad, India (Krantz and Kampen, 1978)

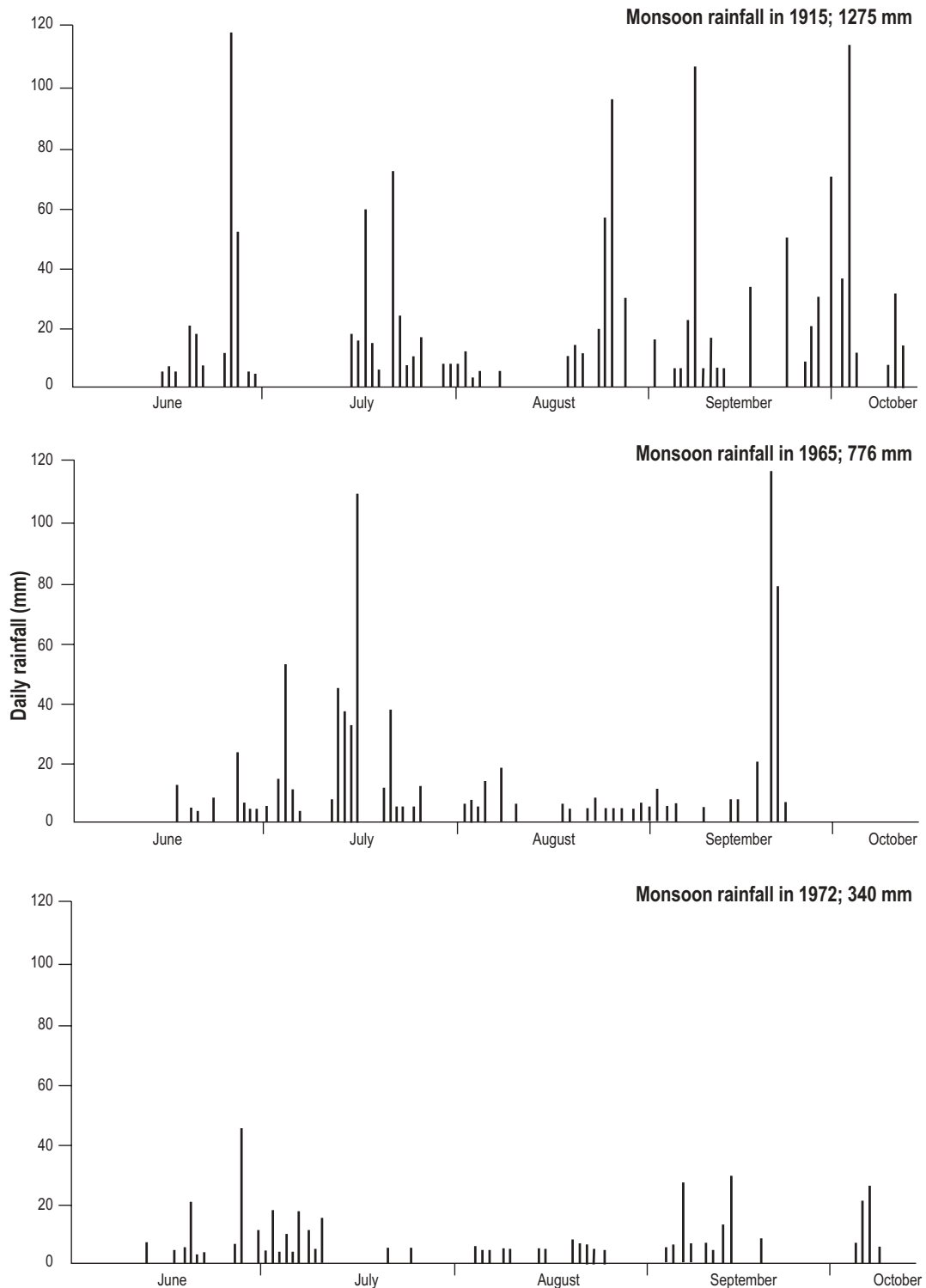

a major contribution in developing and maintaining porosity and may allow plant survival even after water stress may have caused active growth to cease. Considered in this way, the severity of climatic drought can be diminished, inasmuch as plant persistence can be extended and the possibility of post-drought recovery is increased. The provision of permeable soil cover, preferably crop residues, moderates high temperatures in the upper root zone. Soil cover also prevents rain splash and encourages infiltration and markedly reduces the rate of evaporation of water from the upper layer of the soil. This conserves moisture, delaying the onset and shortening the duration of severe stress.

Even where little residue cover is available, soils in good condition under minimal tillage may provide better conditions for seedling growth and survival than those damaged by inappropriate heavy cultivation. For instance, in the dry wheat-growing lands of Western Australia, it was stated that in 2000: “...even no-tilled crops suffered severely with drought. However, their revival was markedly better than in situations where the soil structure had been damaged by tillage. Tilled soil did not receive the rain as well as soil that had softened through the years of no-tillage...

*The crusts from tilled soils are in strong contrast to the soft furrows [made by press-wheels at drilling-time] in the paddocks with a history of no-till. ...*(Western Australia No-Tillage Farmers Association, 2001.)

**FIGURE 14**  
Root systems of two young tea plants of the same clone (MT12) without and with irrigation, after 9 months in the field (Fordham, 1969)

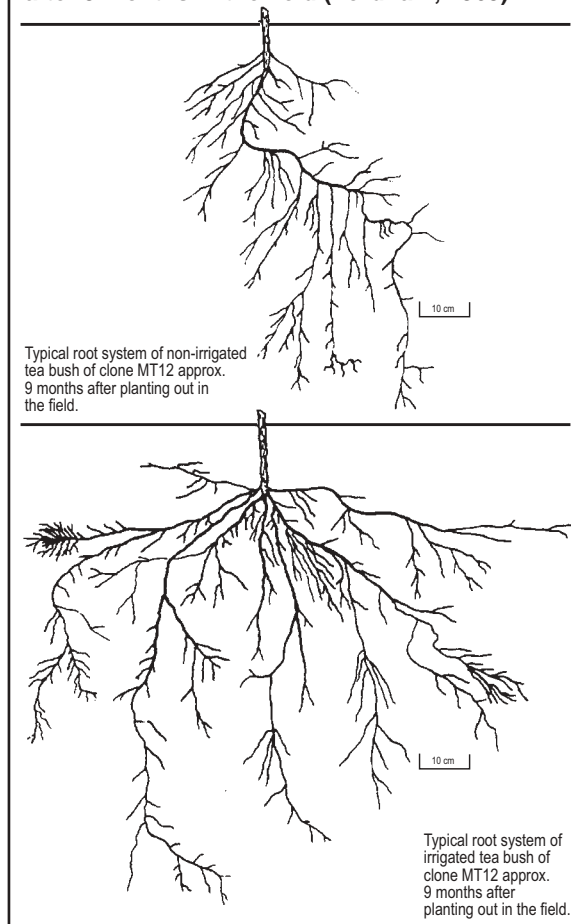

### CHANGING THE PERSPECTIVE ON SAVING SOILS

From this different viewpoint, important changes in emphasis include:

- Focus on saving pore spaces, more than saving solid particles.
- Emphasize increasing infiltration more than reducing runoff.
- To minimize erosion, maintaining a cover of plant residues on the soil is a better first action than building cross-slope banks at intervals downslope.
- On seeing a muddy river in flood, it is more sensible to ask “why so much water?” than to exclaim at the sediment being transported.
- Consider Water and Soil Conservation (WSC) rather than Soil and Water Conservation (SWC).



**PLATE 36**  
**Roots, other organisms and organic materials develop the soil ecosystem from the top downwards – here, on chalk. Purbeck, England**  
*[T.F. Shaxson]*



**Plate 37**  
**Topsoil as a rooting environment developing in an exposed marine clay, through the action of roots and of organic solutes (Poole, England)**  
*[T.F. Shaxson]*

- Think about the principles of what is to be achieved first, before choosing specific practices.
- Reduce risks of failure due to drought, rather than bemoaning increased severity of drought.
- Build soil from the surface downwards, particularly by favouring biotic activity, rather than merely waiting for it to deepen from the bottom upwards (Lovelock, 1991) (Plates 36 and 37).

### CARE ABOUT ROOTS, SOIL ORGANISMS AND WATER

The way the soil is managed as an environment for roots influences the onset, duration and severity of drought, since the roots are suppliers of water and nutrients to the other parts of the plant. Without sufficient water to satisfy plants yields may be limited after even a few days in hot weather. The more severe and prolonged the dry period, the greater the damage to final yields (FAO, 1999a).

A good understanding of the below-ground environment and of how this ecosystem functions is necessary so that it can be managed more appropriately. The key propositions for this understanding are:



- There is a synergy (reflected in plant growth) among the components of the root zone (including the roots themselves) which occurs when their arrangement in the soil volume and the conditions for their dynamic interactions are optimized.
- Minimal disturbance of an optimized arrangement of soil particles, aggregates and pore spaces is crucial to optimum performance of the roots, including the best use of available water in irrigated as well as in rainfed situations. Conversely, disturbance and soil damage in both irrigated and rainfed areas is detrimental to root function.
- To achieve sustainable restoration of damaged soil architecture and of the pore space the soil should be protected from rainfall impact and disturbance by tillage, and should receive regular additions of organic materials.

The organisms in the soil ecosystem break down and transform organic materials, and contribute to:

- the soil's porosity through burrowing and the formation of aggregate-binding gums;
- the soil's water holding capacity via that porosity and water retention by humus;
- the soil's capacity to retain and slowly release plant nutrients;
- the fixation of atmospheric nitrogen.

Soil organisms are subsurface workers, who perform many soil improving activities without cost to the farmers. They deserve more attention than they generally receive on how best to provide for their requirements.

Rainwater for plants' needs should be retained by saving it in the soil where it may benefit all inhabitants of the root zone. Water in excess of these requirements should be able to pass further downwards to contribute to the groundwater, available for use downstream.

These three 'care' suggestions propose an approach aimed at determining the needs of the soil ecosystem of which plant roots are part. This is a necessary step in deciding ways to increase land use intensity without damage to the basic natural resources of water and soil.

## Chapter 4

# Minimizing water stress and improving water resources

### IMPROVING RESTRICTED RAINFALL INFILTRATION

Infiltration depends on there being sufficient porosity in the surface soil for rainfall to infiltrate, and in the subsoil and parent material (if shallow) for rainwater to percolate. When the porosity of the surface soil is too low to accept rainfall, or subsoil porosity is too low to allow rainwater percolation (i.e. permeability is too slow), then infiltration will be restricted and rainwater will be lost as runoff.

The porosity of surface soil may have been reduced by clogging of pores with particles detached from soil aggregates under the impact of raindrops, or by the deposition of detached particles on the soil surface as impermeable crusts or seals. The porosity of subsurface soil may be naturally low, or may have been reduced by compaction and tillage practices that have disrupted or destroyed pore spaces causing a zone of low permeability at the base of the tilled layer. The degree to which soil porosity is reduced by tillage is frequently sufficient to limit root penetration, but is less often so severe that permeability to water is significantly diminished.

The overriding approach should be to instil in society, and in farmers, extensionists and researchers in particular, the will to create and sustain soil conditions that encourage the infiltration of rainfall where it falls, and to counteract the causes of runoff (Jonsson *et al.*, 1999). This implies that the porosity of the soil must be at least maintained, or increased.

The approaches for overcoming restricted infiltration may be categorized according to the cause of the problem as shown in Table 13 at the end of this chapter. Where soil has already been damaged, a combination of two or more of these approaches may be necessary to initiate soil improvement at and beneath the surface.

### Improving the infiltration capacity of the soil surface

Porosity of the soil surface is best maintained by first protecting it from the disruptive action of raindrops through a protective cover, usually of residues from the previous crop, a cover crop or mulch, and by ensuring the soil is not disturbed by tillage. This is best accomplished through what is called Conservation Agriculture, which is described in Chapter 5. The effects of conservation agriculture on higher infiltration and reduced runoff and flooding have been well documented in Brazil in particular (FAO, 2000e).

If the whole concept cannot be applied immediately, improvements in soil moisture status of the soil can still be achieved, though probably not to the same extent, by other measures aimed at prolonging the useful life of rainwater. These include the use of surface residue covers alone, fallow periods under cover crops or natural vegetation, protection or temporary closure of grazing lands and forests from overgrazing, and operations on the contour, complemented by physical measures to detain rainwater.

The regular use of shallow tillage with disc or tined implements to break-up surface crusts to increase surface porosity and enhance rainfall infiltration is not recommended. The increase in surface porosity is only temporary and on crusting-susceptible soils tillage will need to be repeated after every rainstorm. Tillage leads to the disruption of pore spaces in the soil, and the use of discs, in particular, often causes compaction, which may impede root growth and rainwater percolation. Tillage also accelerates the loss of soil organic matter leading to a progressive deterioration of soil architecture and a reduction in the number and stability of pores that allow growth of roots and movement of rainwater.

Regular tillage therefore is not recommended as a solution to restricted infiltration caused by low porosity of the soil surface.

### **Using surface residue covers to increase infiltration and reduce runoff**

A residue cover absorbs most of the energy of the raindrops that fall on it and by the time this rainwater reaches the soil below, its ability to disintegrate soil aggregates and detach fine particles is greatly reduced. Consequently, there is little or no clogging of surface soil pores by detached particles, and little deposition of soil particles that would form a crust on the surface.

The benefits of a residue cover are most apparent on soils initially in reasonable physical condition, but even under these conditions runoff can sometimes occur despite a good soil cover. For example, runoff will occur when rainfall intensity is greater than the soil's infiltration rate, or when the soil's pore spaces are already filled with water because the soil is shallow, its water holding capacity is low, or its subsoil is only slowly permeable.

When a residue cover is applied to a soil with a very degraded surface of low porosity, the beneficial effect of the cover on infiltration may be initially limited. In such situations, it is advisable to accelerate the recuperation of surface porosity before applying residue covers by tilling the soil once to break-up the crust and any subsurface pans, followed by a fallow period under a cover crop to enhance the formation and stabilization of soil porosity. Annex 9 provides a list of publications about cover crops.

The choice of a cover material depends on what is locally available. Residue covers may consist of:

- Crop residues left in the field after harvesting the previous crop.
- Cover crops sown the previous season and left on the soil surface after slashing or applying a herbicide.
- Leaves and branches lopped from trees growing within the cropping area.
- Mulches of grasses, shrubs, weeds, litter, husks and other organic waste materials.

The last option (mulches) requires residues to be collected from elsewhere, transported to the cropping area and then applied in the field, whereas in the other options, the residues are produced within the cropping area.

Examples of materials that may be used as mulches are grasses and sedges, banana leaves and pseudostems (Plate 38), shrubs such as *Lantana* and wild sunflower (*Tithonia*), forest litter and tree loppings (Plate 39). Other materials occasionally used are weeds, rotten thatch and coffee husks. Where soils have a cover of stones, these may be left on the surface as a protective cover provided they do not interfere with planting or weeding operations. Mulching is most commonly practised on horticultural crops that produce negligible residues (foliage), or are completely harvested for their foliage, or are completely harvested (e.g. tuber + foliage).

In the steeply sloping Guaymango area of El Salvador, efforts were made in the 1960s and 1970s to improve crop production by encouraging small farmers to adopt a combination of hybrid seeds, nitrogenous and phosphatic fertilizers, increased plant densities and application of herbicides and insecticides to maize, sorghum, sesame, rice, beans. These recommendations were not particularly successful and in 1973 recommendations for soil conservation were added. These included no burning of crop residues; uniform distribution of residues across the field; use of living or dead barriers; and sowing on the contour in a zero tillage system.

Improvements in crop yield and quality of soil occurred and a high proportion of farmers adopted these measures. Although erosion control was cited as the farmers' main reason for not burning crop residues any more, an important pointer to the benefits due to improved soil moisture conditions was evident in 1997. In that year there was a serious drought during the rainy season associated with the El Niño weather phenomenon. But according to the farmers, they were able to harvest almost as much maize as in a more normal year because of conservation of moisture in the soil as a consequence of the better soil status, while neighbours who had not adopted the system lost their crops to drought. Nor did they lose their crops the following year during hurricane Mitch and the associated torrential rainfall, which caused disastrous flooding. The farmers noticed that the same mulch prevented the seeds from being washed away by rainstorms and facilitated rainwater infiltration so that they did not have problems of decaying plants during the heavy rains (FAO, 2000c). A cross-check on this beneficial effect under the same extreme weather conditions comes from Honduras, where hurricane Mitch caused much erosive devastation on many hillsides, but less on those hillsides where soils were well protected by crop residues (Hellin *et al.*, 1999).

In a limited area of western Honduras the Quesungual traditional agroforestry system has been used by small farmers to produce maize, sorghum and beans. As rising population pressure makes the traditional slash-and-burn system increasingly unsustainable, there is increasing



**PLATE 38**  
**Mulching of bananas with their own leaves and pseudostems and with grasses in western Uganda**  
[R.G. Barber]



**PLATE 39**  
**Example of tree loppings used as a mulch in the Quesungual system (Honduras) to reduce the loss of rainwater through runoff and evaporation**  
[R.G. Barber]

interest among farmers in the Quesungual system. It combines pruning of naturally regenerating indigenous trees and shrubs with normal agroforestry methods for growing high-value timber and fruit-trees. Before sowing, vegetation is cut down by hand without burning and is spread across the field together with the branches and leaves from pollarding. Crop seeds are then scattered or jab-planted with a stick through the mulch layer. Weeds are cleared infrequently, by hand or using a herbicide.

### Mechanisms by which surface residue covers enhance rainwater infiltration

The physical contacts between a residue cover and the soil surface obstruct the movement of the runoff, slowing it down, giving more time for infiltration and so reducing the volume of runoff. Thus two aspects of surface cover can be distinguished:

- *all surface cover* absorbs the energy of raindrops and so prevents the loss of pore spaces into which rainwater can infiltrate;
- *contact cover* slows down any runoff, giving more time for infiltration.

The degree of contact cover is important especially on steep slopes, on soils with naturally low infiltration rates, and on degraded soils with surface crusts or seals of low porosity. Furthermore, it is the contact cover that is immediately accessible to soil macro-organisms and can stimulate their activity. Thus greater numbers of biopores are likely to be formed, leading to more rapid infiltration and percolation. This is why major disturbances such as tillage or incorporation of residues, mulches or other organic matter drastically reduces these positive effects.



**PLATE 40**

**Maize on a steep slope with a degraded soil surface covered by stiff long-stawed stems of a bush. Despite a 90 percent aerial cover there was high runoff because of the restricted contact between the vegetation and the soil surface, and the low surface porosity of the soil, Morazan, El Salvador**

[R.G. Barber]

Pliable materials of short length, such as leaf or grass mulch, which can be easily flattened by raindrops, will develop a high degree of contact cover and will substantially slow down the speed of runoff flow, generally resulting in reduced volumes of runoff. In contrast, inflexible long materials, such as woody branches of tall bushes that are not easily flattened by raindrops, will develop a low contact cover and so have less influence on the speed of runoff flow (Plate 40).

### Advantages of surface residue covers

The advantages of mulches are the same as for crop residue, i.e. increased infiltration, decreased runoff (Lal, 1976), and greater soil water availability. They both provide additional benefits, notably less soil water losses by evaporation, less weed incidence and water losses by transpiration, softer and more workable soils, increased earthworm activity (Lal *et al.*, 1980), the incorporation of additional nutrients (FAO, 1999b) and frequently increased yields.

In western Kenya, mulching with *Tithonia* has given substantial yield increases of maize, kale, tomatoes and French beans. Net profits from mulching kale ranged from US\$91 to US\$1 665 per ha (ICRAF, 1997). In the semiarid zone west and north-west of Mount Kenya, maize yields



increased by a factor of 4.4 when 3 t/ha of mulch were applied (Liniger, 1990). Termites were not a problem in this area, probably because of the cool climate.

### **Constraints to using surface residue covers**

The main disadvantage of applying mulch is the cost or labour of collecting, transporting and applying the mulch. This is not the case with crop residues, which are produced on-site. Often, there will be no suitable mulching materials in the vicinity of the farm, or there is insufficient labour available. Transporting large quantities of mulch for large-scale cropping is seldom economic and mulches cannot be applied after emergence to closely spaced crops.

When a cover crop is used as mulch, there is the cost of slashing the cover crop or applying a herbicide. Similarly, lopping trees and distributing the branches and leaves over the cropping area requires considerable labour. On steep slopes, the application of residue covers is not easy and requires much labour as well. Moreover, these materials are easily washed downhill on steep slopes.

Mulching materials and crop residues are often grazed by cattle belonging to the farmer, the community or the landowner (in the case of tenant farmers), fed to livestock, or sold as fodder. Sometimes these materials are in demand for thatching or fuel; in many semiarid areas they are rapidly consumed by termites, and in hot humid climates, they decompose rapidly. Another disadvantage of mulches is a progressive decrease in soil fertility where the mulching materials are produced, unless manures or fertilizers are applied. In parts of Uganda, the residues of cereals grown on hillsides are used to mulch bananas on the lower slopes or valley bottoms, which become enriched in nutrients at the expense of the cereal areas. Soil erosion may also degrade the source areas when the cover provided by the vegetation is removed for use as mulch.

### **The amount of residues needed**

In relation to increasing infiltration, studies over two seasons in Nigeria on slopes of 1 to 15 percent have shown that 4 t/ha of rice straw mulch, equivalent to about 80 percent cover, will reduce runoff to 5 percent of the seasonal rainfall (Lal, 1976). A similar result has been found on a 12 percent slope with a well-structured freshly cultivated soil in Kenya, where 4 t/ha of grass mulch equivalent to 79 percent cover, reduced the runoff from simulated rainfall to 5 percent. On the basis of these data an 80 percent cover, equivalent to about 4 t/ha maize straw, would appear to be appropriate for increasing rainwater infiltration.

### **Conditions favouring the adoption of surface residue covers**

The use of soil covers is more common in subhumid and humid zones because of the greater availability of vegetative materials. Nevertheless, they are particularly suited to semiarid areas when materials are available and in the absence of severe termite problems. Mulches are often applied to limited areas of high-value horticultural crops and home gardens in easily accessible fields with gentle slopes.

### **Fallowing under cover crops or natural vegetation**

When soils are so badly degraded that they must be taken out of production, soil porosity can be restored through the action of biological processes. This can be achieved by fallowing for 1 or several years under natural vegetation, natural vegetation enriched with fast-growing leguminous

trees, or planted fallows. The accumulation of large amounts of biomass on the soil surface from the fallow vegetation associated with high biological activity and strongly developed root systems promote the biological recuperation of soil porosity. Biological incorporation of residues into the surface soil results in higher soil organic matter in the upper few millimetres, which progressively extends into deeper layers overtime. The permanent cover of surface residues encourages soil faunal activity, which combined with higher soil organic matter contents leads to improved soil porosity (FAO, 1995c).

A well-adapted, deep-rooting leguminous cover crop often speeds up the recuperation of soil porosity compared with a natural vegetation fallow because larger amounts of biomass are rapidly produced by the cover crop. Whereas a natural vegetation fallow may require 3-5 years, a cover crop may recuperate soil porosity in 1 year. When degraded soils are severely compacted, deep tillage with a subsoiler immediately prior to sowing the cover crop encourages establishment and development of the cover crop. If the degraded soil is severely deficient in phosphorus the application of P fertilizer will be necessary to encourage the establishment of the cover crop.

A constraint of soil recuperation by natural vegetation fallows in mechanized production systems is the problem of eliminating trees and excavating roots before returning to cropping. If a manual system is to be adopted, the problem is less serious. Herbaceous and shrubby cover crops can be eliminated much more easily by slashing, mowing or application of a systemic herbicide, and the subsequent crop may be sown directly into the residues of the cover crop.

### **Temporary closure of grazing lands and subsequent protection**

Low infiltration and high runoff can occur on grazing lands even on slopes less than 2 percent, as for example at Sebele, in Botswana. In this area, vegetation cover was considered to be the most important factor controlling infiltration and runoff, and catchments with a cover in excess of 70 percent generally had lower runoff compared with those with less than 70 percent cover (LWMP, 1992).

Although the percentage of grass cover in grazing lands has an important influence on rainfall infiltration, soil surface porosity can be more important, especially when overgrazing has degraded the soil, resulting in surface compaction and very low porosity (Plate 41). On degraded grazing lands at Iiuni, Kenya, for example, even with 57 percent vegetative cover the runoff was in excess of 60 percent (Moore *et al.*, 1979). The presence of algae growths on bare surfaces that were resistant to wetting encouraged runoff, whereas stone covers reduced runoff due to the creation of water-storage areas between the stones where the rainwater is detained, allowing more time for infiltration (Barber and Thomas, 1981).

### **Importance of forest protection for water infiltration**

Forest provides an excellent protective cover made up of the canopy, low-storey bushes, herbs and surface litter, which combine to protect the soil surface from loss of porosity by direct impact of raindrops. The litter also serves as a food and energy source for soil organisms, which encourages the formation of soil organic matter and faunal passages leading to high infiltration rates.

Where forests are not protected from grazing and litter is consumed by livestock, removed for use as mulch as in parts of Nepal, or is lost in fires, the surface cover may be diminished to such an extent that the soil becomes bare. This is likely to be more serious under trees that

**PLATE 41**

The land in the foreground is a clay soil with an unstable surface and an argillic horizon; it was previously arable land, but after developing a plough pan at 12-15 cm depth, it was abandoned to grazing. A surface crust of very low porosity has developed which encourages runoff, strongly reducing the amount of moisture available for use by grasses. This combined with heavy grazing has resulted in a denuded land surface – Machakos, Kenya

[R.G. Barber]

**PLATE 42**

Example of compacted soil beneath a *Tectona* (teak) plantation, which resulted in high runoff and erosion – Jocoro, El Salvador

[R.G. Barber]

discourage the growth of understory herbs and shrubs, such as teak (*Tectona grandis*) and some species of *Eucalyptus* due to shade, high water use – especially by *Eucalyptus* – and to a lesser extent because of the acid nature of the litter. If the tree canopy is high, accumulated rainwater drops that fall off the leaves may be larger than normal raindrops and can fall with sufficient velocity to cause more damage to the soil than if there were no tree cover. This can lead to a pronounced loss of soil porosity, as can trampling by livestock, resulting in restricted infiltration and high runoff despite the high canopy cover (Plate 42).

The protection of forests from overgrazing is an important management issue in overcoming restricted infiltration, and the establishment of forest user groups is often a crucial step in effectively controlling overgrazing and the loss of surface soil porosity. Forest user groups are most likely to be successful where indigenous forest management systems have existed (Kandel and Wagley, 1999).

### **Increasing the period for infiltration by detaining runoff with physical structures**

Alternative, but less favourable solutions to restricted infiltration are the use of physical structures, which may be necessary under certain situations:

- When it is not immediately feasible to implement conservation agriculture or simple soil cover because, for example, crop residues are used as fodder.
- As backup measures to support conservation agriculture where the problem of restricted infiltration is due to rainfall intensities that are higher than soil infiltration rates even in the presence of a residue cover.



**PLATE 43**  
**Contour cultivation creating small ridges and depressions parallel with the low marker-ridge at top right – Umuarama, Brazil**  
 [T.F. Shaxson]

**PLATE 44**  
**Despite earth bunds constructed approximately parallel to the contour, planting tobacco in a downslope direction has led to serious gully formation from right to left, resulting in breakage of the bunds – Kasungu, Malawi**  
 [T.F. Shaxson]



In these situations, the volume of water soaking into the soil may be increased by giving more time for infiltration by slowing down runoff, by means of physical or vegetative structures constructed across the slope and parallel to the contour.

Closely spaced structures on the contour (e.g. ridge and furrow series of planting lines and irregularities formed by contour tillage and crop management operations) may be formed over the whole field so that rainfall is detained where it falls. Widely spaced structures at intervals down the slope (e.g. fanya juu terraces, stone walls, earth bunds, live barriers and trash lines) used on their own without contour field operations between them will result in rainwater running downslope until it is detained or slowed down at the next barrier.

Details of the layout, design, construction and maintenance of these structures appear in many Soil and Water Conservation (SWC) handbooks, such as *Soil conservation* (Hudson, 1995), *Soil and water conservation manual for Kenya* (Thomas, 1997), *FAO Soil Bulletin 70* (FAO, 1996a), *A land husbandry manual* (Shaxson *et al.*, 1977) and other documents produced by governmental and other agencies for specific countries or particular environmental conditions.

## CONTOUR FIELD OPERATIONS

On sloping land all field operations such as tillage, planting, weed control, spraying and harvesting should be carried out along the contour. Ridges and mini-depressions along the contour create small storage volumes where rainwater can accumulate, allowing more time for infiltration (Plate 43). Field operations conducted in a downslope direction can cause a devastating impact resulting in high runoff losses and soil erosion (Plate 44).



Narrowly spaced contour planting ridges with and without cross ties have the advantage of detaining rainwater where it falls so that there is more time for soak-in, and can be an effective means of encouraging infiltration and preventing runoff in semiarid and the drier subhumid areas. An additional advantage is that working along the contour makes operations such as harvesting easier and quicker.

### **Constraints of surface irregularities formed by contour field operations**

The surface depressions have limited capacity to retain water and on sloping land the effective storage volume rapidly diminishes as slope increases. On slopes greater than 5 percent the effective storage volumes are considerably reduced. Reductions in storage volume will also occur on soils with a low structural stability, as the small ridges slump into depressions on becoming wet. Substantial runoff can occur even on land of 1-2 percent slope when the soils are of low stability and susceptible to crusting. Even on structurally stable soils, depressions may be quickly overtopped by the accumulation of rainwater from all but the lightest of rainstorms.

### **Conditions favouring the adoption of contour field operations**

The only exceptions to contour cultivation may be in high-rainfall areas where the soils have high infiltration rates and high susceptibilities to mass movements, e.g. landslides and mudflows. In these situations high soil water content increases the risk of mass movements, and so it may be better to encourage controlled runoff of some of the rainfall. Since the effectiveness of contour field operations in reducing runoff is limited on all but the gentlest slopes, it should be considered as just one of the practices necessary to increase water availability.

### **Narrowly spaced contour planting ridges and tied ridges**

In tied ridges the ties are constructed at intervals across the furrows formed by the contour ridges (Plate 45). These structures are usually constructed with animal traction or tractor power and may be formed annually or can be semi-permanent (Plate 46). They may also be made by hand but labour demands are high. The precise form and management of contour ridges and tied ridges vary considerably, with the optimum design and management being dependent on the crop, rainfall and soil type.

Contour ridges run the risk of being overtopped if too much rainwater accumulates within the furrows. They also may be breached or collapse at low points where large volumes of runoff accumulate from along the furrows (Plate 47). If large volumes of water frequently accumulate a subsurface pan or horizon of restricted permeability may be present beneath the furrows.

**PLATE 45**  
**Example of graded contour ridges with cross ties lower than the main ridges to retain water between the cross ties, but allow excess rainwater to flow between the ridges rather than spill over or break the main ridges**  
*[T.F. Shaxson]*







**PLATE 46**  
**Making cross ties – Makoka, Malawi.**  
*[T.F. Shaxson]*

These risks can be reduced by carefully laying out and maintaining the ridges and furrows to ensure there are no low points and by constructing tied ridges to prevent lateral movement of water along the furrows towards any low points that may exist. The ties should be spaced at 1 to 3 metre intervals along the furrows and no more than half to two-thirds the height of the ridges. Although tied ridges require additional work, they provide good insurance against the collapse of ridges at low points during heavy rains and the loss of rainwater by discharge from the ends of the furrows if a slight gradient exists.

The furrows of contour ridges are normally aligned parallel to the contour. However, if very large volumes of runoff are periodically expected, tied ridges should be installed and the furrows constructed on a slight gradient (never steeper than 2 percent in the direction of a natural watercourse) so that excess rainwater is discharged along the furrows to prevent overtopping of the ridges. In these circumstances well-designed discharge points will be necessary at the furrow outlets. The size and spacing of the ridges should coincide with the crop's recommended spacing, furrow width and depth.

Ridges and tied ridges may be constructed prior to, or after, planting. Maize is often planted on the flat, and the ridges constructed at the time of the first weeding about 30 days after planting, which saves labour. Clearly, the earlier ridges are constructed the more rainwater they will be able to detain, and the greater the probability of a good yield. The time when ridges are constructed is also a convenient time to simultaneously incorporate manures.

#### **Advantages of narrowly spaced contour ridges and tied ridges**

The main advantage of contour ridges and tied ridges is the greater accumulation of rainwater within the furrows due to the retention of potential runoff (Njihia, 1975) (Figure 15). The concentration of water in the furrows encourages deeper percolation, but for this to be useful to the crop, the soil's AWC must be sufficiently high to retain the accumulated water within reach



**PLATE 47**  
**Example of the effects of excessive rainwater breaching contour ridges at low points resulting in loss of rainwater by runoff and severe soil erosion – Mua, Malawi**  
*[T.F. Shaxson]*

of the crop roots. Sandy soils with a low AWC may permit a large proportion of the rainwater to drain beyond the zone penetrated by the roots.

### Constraints of narrowly spaced contour ridges and tied ridges

The continual formation of ridges each year by hand or by mechanization, combined with trampling along the furrows, may result in the formation of a compacted horizon at the base of the ridges, which can prevent roots from penetrating into deeper layers. This will counter the advantages provided by the ridges of increasing the supply of available water. The exposure

of the soil surface leads to an accelerated loss of soil organic matter and surface crusting due to the effects of tillage, raindrop action and direct exposure to the sun, and very little macrofaunal activity. Consequently, the soils rapidly become degraded.

Another constraint is the time required to construct contour ridges, with even more time needed for tied ridges. The manual construction of contour ridges needs about 100 hours per hectare (Morse, 1996), and heavy textured soils will be even more demanding. To form ridges by hand or by animal traction in hardsetting soils will generally only be possible once the first rains have moistened the soil. The process of manually constructing contour ridges on sloping land, where the farmer faces uphill and pulls the soil into ridges with a hoe, causes soil to move downhill, so encouraging soil erosion (Plate 48).

### Conditions favouring the adoption of narrowly spaced contour ridges and tied ridges

Contour ridges and tied ridges are most suited to areas suffering from water deficits where it is not feasible to provide a soil cover to enhance infiltration and reduce runoff through the use of crop residues, mulching materials or cover crops (Plate 49).

The manual implementation of these structures will only be possible where sufficient labour is available and where farmers consider that the high labour requirement is justified by the value of the crop. These structures are particularly suitable for the production of tuber crops.

### Impermeable and permeable contour barriers at discrete intervals downslope

These structures include stone lines, walls, earth banks, fanya juu terraces, trash lines, live barriers and similar constructions. They have usually been installed to prevent small rills developing into gullies by limiting the area over which runoff collects, with or without sideways diversion

**FIGURE 15**  
**Fate of rainwater for three soil management practices (Morse, 1996, adapted from Moyo and Hagmann, 1994)**

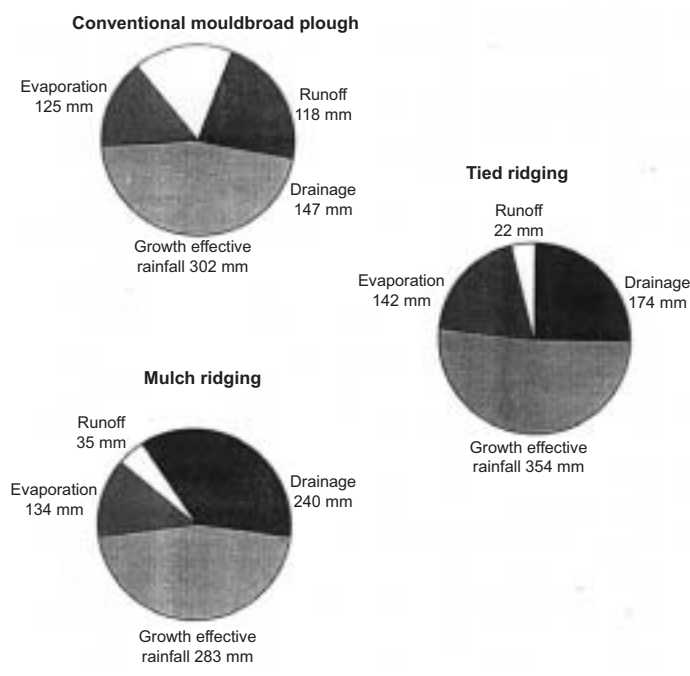



**PLATE 48**  
Farmer constructing ridges for potato cultivation in southwest Uganda. The action of pulling the soil downhill to form ridges is contributing to soil movement and erosion  
[R.G. Barber]

**PLATE 49**  
Mulch, cross tied planting ridges and an earth bund (as backup) provide multiple means of catching rainwater for the benefit of young tea. Weeping lovegrass has been planted along the bund to provide future mulch. Mulanje, Malawi  
[T.F. Shaxson]



**PLATE 50**  
Earth bund stabilized with *Phalaris* sp. and combined with zero tillage – Chapecó, Brazil  
[R.G. Barber]

**PLATE 51**  
A broad-based earth bund set on the true contour can cause local waterlogging if the collected runoff cannot soak in or flow away. Kasungu, Malawi  
[T.R. Jackson]



into prepared waterways for safe disposal downslope. The barriers, which they provide may, if well maintained, accumulate soil which has been eroded from upslope.

In many situations, the chief benefit of laying out structures along the contour, at discrete intervals downslope, is their use as guidelines for the alignment of contour field operations in the cropping areas between them (Plate 50). The capture and soak-in of runoff along the upper sides of these structures may be considered as an added, rather than a primary, benefit.

The more closely spaced the banks, the more frequently runoff will be intercepted, but the more of the farmer's land will be taken out of production, unless some useful crop is planted along the earth bank. In semiarid areas structures can be designed for the purpose of water harvesting, which provides the extra water needed for adequate yields, if only from a relatively narrow strip.

If the strip of land immediately upslope of the barrier has been made impermeable by passage of machinery or of feet, or the soil itself is relatively impermeable, temporary or more long-lasting local waterlogging can be induced (Plate 51).

If more runoff accumulates than the structure can hold back on its upslope side, it will overtop and may break, with the resulting concentrated flow of accumulated water often causing more damage downslope than if the structure had not been there at all.

### Conditions favourable for adoption of impermeable cross-slope barriers for water conservation

In areas of moderate to high rainfall, such barriers may be appropriate where they complement water-absorptive conditions, good surface cover and/or ridge and furrows, with or without tied ridges. If they are laid out on the level contour they may have some small additional effect on increasing water in the soil (Figure 16).

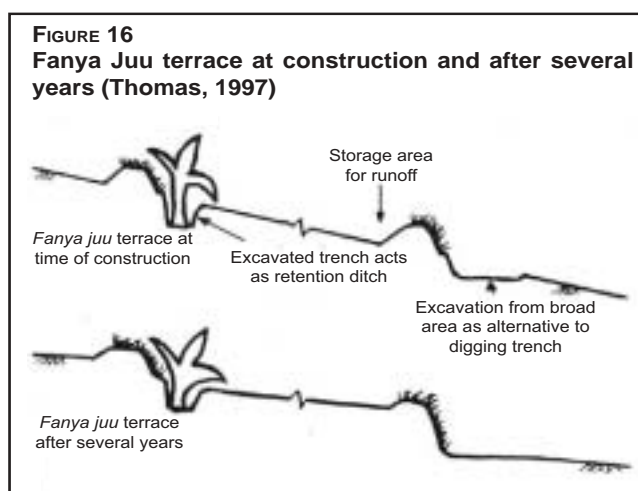

### Permeable cross-slope barriers

Permeable barriers, which may be accumulations of stalks, branches, crop residues, leaves (trash lines) without or with a line of one or more crops, forage grasses, shrubs or trees (live barriers) may impede but not stop runoff. The lower speed as runoff passes tortuously through the material provides an opportunity for infiltration. The live barrier may benefit from the additional soil moisture, but the additional transpiration through deep-rooted plants may minimize the volume, which could flow beyond the roots to groundwater. If the farmer receives no benefit from the live barriers, then the competition effects for light and moisture would be a disincentive (Plate 52).

### Bench-type terraces

These structures are a total modification of natural land slopes into a series of platforms which are almost level or slope at shallow gradient across or along the terrace. Controlling the gradient





**PLATE 52**  
**Example of a live grass barrier of a hybrid**  
**between *Pennisetum* sp. and *Phalaris* sp.**  
**associated with an earth bund. Chapecó,**  
**Brazil**  
 [R.G. Barber]



**PLATE 53**  
**Bench terracing for horticultural crops**  
**– Costa Rica**  
 [R.G. Barber]

in this way allows management of water movement on what were formerly steep slopes. The cultivation platform may be continuous along the slope (bench terrace, Plate 53) or discontinuous (orchard or platform terrace). The surface of the intervening uncontrolled slopes is preferably covered with a close-growing grass or legume as a soil-protecting cover.

Bench-type terraces are arduous and expensive to construct, requiring up to 700 person-days per hectare. Their capacity to receive and store rainwater depends on the depth, condition and quality of the soil into which they have been constructed. In semiarid areas they may be able to catch and detain all the rain that falls. In places with greater volume and frequency of rainfall, provision may have to be made for disposal of excess water down very steep waterways, and there is also an added danger of landslips if the benches become saturated.

### **Deep tillage to increase subsoil porosity and permeability**

Rainwater infiltration may be restricted in soils where the pore spaces rapidly become saturated with water because of the presence of dense subsoil horizons of low permeability. In these situations an initial deep tillage of the whole field with a tined implement, subsoiler or paraplow to break-up the dense horizon may improve subsoil permeability and so allow more rainwater to infiltrate. By improving subsoil permeability the rate of oxygen supply to the crop roots will also improve. However, the beneficial effects of deep tillage may only last 2 to 3 years.

### **REDUCING WATER LOSSES FROM EVAPORATION AND EXCESSIVE TRANSPIRATION**

The most effective solution to high evaporation losses of soil water is a cover of plant residues on the soil surface. Agronomic practices that increase shading of the soil surface, and physical



structures that concentrate rainwater, encouraging percolation to deeper layers, also reduce evaporation losses. Wasteful transpiration losses may be the result of weeds or excessive crop transpiration in hot windy conditions, and can be reduced by appropriate weed control practices and windbreaks, respectively.

### **Minimizing evaporation from the soil surface**

Surface residues reduce soil water losses through evaporation by acting as an insulating layer. This diminishes the temperature of the surface soil and eliminates the effect of wind. Heat from the sun is only slowly transmitted from the surface of the residues through the air trapped within the layer of residues to the soil surface. Consequently the soil surface remains cooler and the rate of evaporation of soil water is slowed down. The thicker the layer of trapped air, the greater will be the insulating effect, and the quantity of residues required to reduce evaporation losses is considerably greater than the quantity needed to ensure that most rainfall infiltrates where it falls.

For example, in Uganda, farmers traditionally apply between 8 and 40 t/ha of mulch to bananas (Briggs *et al.*, 1998), whereas 4-5 t/ha are probably sufficient to minimize runoff and allow most of the rainfall to infiltrate. Banana yields respond very favourably to mulching, and applying 5-10 cm depth of maize stover and *Paspalum sp.* to bananas at Sendusu, Uganda, increased yields from 4.3 to 10.8 t/ha (Speijer *et al.*, 1998). Experiments in Uganda have shown that yields approximately doubled when 30-40 t/ha of mulch were applied compared with applications of 10-20 t/ha (Briggs *et al.*, 1998). This yield increase was mainly attributed to lowered evaporation losses. Protecting the soil surface from wind also slows down evaporation by reducing the rate at which water vapour is removed from the soil surface.

The use of residue covers for conserving soil moisture in the topsoil and increasing yields is particularly important in regions with limited rainfall and high evaporation rates. It is also important for shallow-rooted crops, e.g. bananas, tea, coffee, pineapple, and vegetables such as onion, lettuce, cabbage and carrots. Residue cover can also be very beneficial in reducing water losses by evaporation from soils with a shallow water table (less than 1 to 2 metres), from which there may be capillary rise of the subsurface water. Such soils are often used in horticultural production.

However, the main disadvantage of using residue covers for reducing direct evaporation is the large quantities of residues required to significantly reduce evaporation. Often, the regions with high evaporation losses also suffer from a shortage of rainfall, which restricts the production of vegetative matter. Frequently there are also other demands on residues, which take priority such as fodder, thatching and construction.

### **Reducing excessive transpiration**

In hot windy weather, the rate of loss of water through plants by transpiration can be very high and can result in early depletion of limited soil moisture reserves. This in turn can lead to serious water stresses developing in plants – both crops and weeds – before their cycle of growth to maturity has been completed.

### **Weed control**

Loss of soil water through weed transpiration can seriously reduce the amount of water available to crops. Consequently, timely and effective weed control practices are essential. The presence

of a thick layer of residues on the surface is a very effective way of controlling weeds. Where weed control measures are needed, the use of herbicides or appropriate crop rotations is often preferable from a conservationist perspective to mechanical weed control, unless it is practised with no soil disturbance. Post-emergence herbicides leave weed residues on the soil surface as a protective cover whereas cultivation leaves soil exposed to the impact of raindrops and sun, accelerates drying of the surface soil and tends to disrupt and destroy soil porosity through smearing and compaction.

### Windbreaks

When crops are exposed to strong winds in a dry environment the water that has been transpired by the crop is rapidly removed from the leaf surfaces into the atmosphere. This encourages a more rapid movement of water up through the crop and much greater absorption of water from the soil. Strong winds can therefore cause excessive crop transpiration rates and an unnecessary loss of soil water.

Windbreaks will significantly reduce wind speed and so reduce crop transpiration rates and the unnecessary loss of soil water. Windbreaks are usually established by planting single, double or triple rows of trees, but sugar cane or tall grass species may also be used. In areas where forests are being cleared for agricultural development, strips of the original forest may be left as natural windbreaks.

Important considerations in the design of planted windbreaks are their composition, orientation, height, porosity and spacing (McCall *et al.*, 1977; Barber and Johnson 1993). Windbreaks should be oriented at right angles to the direction of the prevailing winds during the growing season. As a general rule, they should occupy no more than 5 percent of the cropped area. For small production units a single row of trees is usually most appropriate. Paths and roads should not cross windbreaks to avoid channelling of the wind through the openings at high velocities. The tree species selected should be adapted to the climate and soils of the area (Shigeura and McCall 1979; Johnson and Tarima 1995). The foliage should not be so dense that most of the wind is forced to pass over the top of the windbreak, as this will cause severe turbulence on the downwind side of the windbreak, which can seriously damage the crop. The porosity of the windbreak vegetation should ideally be 40 percent so that part of the wind passes through the windbreak. This will give a 50 percent reduction in the velocity of the wind within a distance of ten times the height of the trees (Skidmore and Hagen, 1977). When there is sparse protection in the lower part of the windbreak, as shown in Plate 54, it is advisable to allow regeneration of shrubs within the windbreak or plant tall grasses (e.g. *Pennisetum purpureum*) or sugar cane to ensure a more uniform protection from top to bottom. Maintenance of the



**Plate 54**  
A single row windbreak of *Leucaena leucocephala* with little foliage at 0-2 m height, providing inadequate protection to the crop – Santa Cruz, Bolivia  
[R.G. Barber]

windbreaks is important to ensure that no holes appear, to regulate the porosity of the vegetation to wind and to avoid excessive shading and weed infestation of adjacent crops.

Natural windbreaks are strips of forest left after deforestation. Since a much drier and windier microclimate develops in these strips of forest compared with that in the undisturbed forest, many trees in natural windbreaks often die, sometimes leaving holes through which the wind passes at increased velocity. The important guideline for natural windbreaks, as for planted windbreaks, is that the porosity of the vegetation should be about 40 percent. In open forests in particular, natural windbreaks may need to be substantially wider than planted windbreaks to allow for the death of some trees. Alternatively, planting individual trees to fill gaps, or enriching the natural windbreak with one or two rows of additional trees may be necessary to produce a protective cover of 40 percent porosity.

Well-designed windbreaks will significantly reduce evapotranspiration rates of crops in windy conditions resulting in the conservation of soil water and less subsequent moisture stress when water is limiting. A 50 percent reduction in wind velocity (from 32 to 16 km/h) will reduce evapotranspiration rates by 33 percent (McCall and Gitlin, 1973). Windbreaks may provide additional benefits to crops by reducing mechanical damage and the loss of flowers, and by creating better conditions for insect pollination. They are also beneficial in reducing wind erosion, especially in fine-sandy and silty soils, and in diminishing air pollution problems. Depending on the tree species selected, windbreaks may also provide fruit, nuts, fodder and timber, but the harvesting of these products must not result in pronounced gaps being formed within the windbreak.

The main disadvantage for farmers with small plots is the loss of cropping area due to the windbreak and the risks of competition between the windbreak and the crop for water, nutrients and light leading to lower crop yields. This zone of competition may extend over a distance equal to 1.5 times the height of the windbreak.

In areas where there are severe shortages of fodder, fuelwood and timber, windbreaks may need to be fenced to prevent indiscriminate grazing and harvesting. To ensure that wind cannot pass around the ends of individual windbreaks, the establishment of windbreaks should be planned on a community basis.

### **Conditions favouring the adoption of windbreaks**

Windbreaks will be favoured in areas subject to strong dry winds during the growing season, and where windbreaks cause a net gain in soil water (i.e. where the gain in soil water due to reduced crop transpiration exceeds the loss of water due to windbreak transpiration). Windbreaks are also likely to be favoured where they consist of species that provide additional benefits, such as fodder, fruit, nuts, fuelwood and timber that can be harvested without damaging the windbreak.

### **Shade**

Shade can be provided by all manner of materials, whether artificial such as nets, cloths, plastic sheets and others, or plant-derived, such as cut branches, cut grass supported on nets, or living trees which provide high-level and wide-spreading shade. Shade is necessary in plant nurseries in hot regions to protect seedlings and other plants with shallow roots from rapid desiccation. While shade may ameliorate the severity of hot dry conditions and limit undesirable losses of

soil moisture, it can also be so dense as to limit solar energy reaching leaf surfaces and limit photosynthesis and growth rates.

Where shade may be desirable, its density should be adjusted to provide an appropriate balance between losing water too fast, limiting sunlight intensity and avoiding scorching of leaves due to temporary dehydration and cell-damaging high temperatures. Using living shrubs and trees to provide long-term shade for tea and coffee can cause difficulties in maintaining the desired degree of shade above the crop over the long term.

## **REDUCING RAINWATER DRAINAGE BEYOND THE ROOTING ZONE**

### **Soils without restricted rooting**

In regions where much of the rainfall occurs as light showers, the concentration of rainwater as near as possible to the crop will cause more of the rainwater to infiltrate deeply, where it is less susceptible to evaporation. In order not to lose this water by drainage beyond the crop's rooting zone and where there is no rooting restriction some solutions can be adapted, such as increasing the capacity of soils to retain water within the rooting zone, early planting to accelerate root development or changing to deeper-rooting crops.

### **Increasing available water capacity of soil**

The addition of large quantities of organic manure will increase the available water capacity (AWC) of soils and in theory this is a useful practice for reducing deep drainage losses. However, even in temperate climates the quantities of organic materials required to markedly increase AWC are very high, applications must be continued over many years and usually affect only the plough-layer depth (Russell, 1988). In tropical zones, where organic matter decomposition rates are much higher, the influence of organic manures on AWC is likely to be even less. Nevertheless, this practice may be feasible for small-scale farmers growing high-value crops where large quantities of organic manures and labour are readily available.

### **Dry planting**

In low rainfall areas, it is frequently difficult to know when the rains have truly started, as initial rains are often followed by a dry period. Many farmers wait until the topsoil has been moistened to a depth of about 15-20 cm before planting, so that even if there is a subsequent short dry period there is sufficient water within the soil. However, this results in a delay in planting and for every day's delay yields will decrease (by about 5-6 percent for maize in eastern Kenya, Dowker, 1964), largely due to the loss of rainwater by drainage and evaporation, together with the loss of some released nutrients.

To overcome this problem and to allow crops to develop deeper rooting systems earlier on so that more of the rainfall can be utilized during the initial stages of the season, some farmers "dry plant" when soils are dry prior to the onset of the rains. To avoid premature germination before sufficient rain has fallen, the seeds are usually placed deeper than normal. Dry planting also has the advantage of spreading labour over a longer period. Crops may also benefit from this practice by being able to utilize the nitrogen released at the start of the rains from the decomposition of soil organic matter, which reduces leaching and pollution of groundwater. However, there are a number of problems associated with dry planting, notably that some soils, and in particular hardsetting soils, are difficult if not impossible to till when dry. If seeds

are not planted sufficiently deeply, they may germinate at the first rains and then die during a subsequent dry period.

### **Improving plant nutrition for early root development**

Applying fertilizer to speed up crop canopy development and increase the shading of the soil surface will decrease the soil water lost by evaporation so that more is available to the crop. Planting crops equidistantly (i.e. with between-row spacing similar to within-row spacing) so that the soil surface becomes shaded more quickly would also be expected to reduce the proportion of soil water lost by evaporation. However, the effects of these agronomic practices on reducing evaporation losses will be much less than applying surface residues.

### **Introducing deep-rooting crops**

On permeable sandy soils that retain small quantities of available water for crop use, it is preferable to introduce deep-rooting crops that can utilize soil water at depth that would not be available to shallow-rooting crops. Examples of deep-rooting crops are almond, barley, cassava, citrus, cotton, grape, groundnut, olive, pearl millet, pigeon pea, safflower, sisal, sorghum, sunflower, sweet potato and wheat.

## **IMPROVING SOILS WITH RESTRICTED ROOTING**

The type of solution to be applied will depend on the cause of root restriction. The most frequent cause is physical root restriction due to a lack of pores that are large enough to be readily penetrated by roots or which can be sufficiently widened by the growing roots. This condition occurs in dense layers, such as plough pans formed by tillage, but also in naturally occurring dense layers as found in hardsetting soils. Root restriction may be overcome, at least temporarily, by biological or mechanical means. In addition to eradicating the causes of root restriction it is also important to take steps to avoid future recurrence of the problem by, for example, introducing conservation agriculture where dense layers have been formed by tillage.

Less common causes of restricted rooting are chemical restrictions due to the presence of toxic concentrations of aluminium or manganese, high salinity or severe nutrient deficiencies, especially of phosphorus. A lack of oxygen due to a fluctuating water table may also restrict root development. While the water table is high, root development for most crops will be restricted to the soil immediately above the upper level of the water table but the crop will not suffer from a lack of moisture. If the water table then falls relatively quickly to a substantially lower level, for example at flowering, when the crop has still to reach physiological maturity but the roots have ceased growing, the roots may be left stranded in the dry soil without access to the moisture in deeper layers.

The causes of restricted rooting given above can, where appropriate, be overcome by the application of lime, or lime and the more mobile gypsum, to eradicate aluminium and manganese toxicities; leaching to reduce salinity hazards; fertilizers to rectify nutrient deficiencies; or drainage to remedy the lack of oxygen from a fluctuating water table.

The principal biological method of restoring the porosity of root-restricting layers is to place the land in fallow and utilize the roots of natural vegetation or planted cover crops to act as biological subsoilers penetrating the dense root-restricting horizons (Elkins, 1985). The stability of root channels created by plant roots will be greater than that of channels formed by



**PLATE 55**

*Tephrosia vogelii* for regenerating soil fertility through its effect as a biological subsoiler in breaking up the hardpan, and of producing high biomass and fixing nitrogen to increase soil organic matter and nitrogen contents – Zomba, Malawi [T.F. Shaxson]

mechanical methods because of the release of organic substances from the roots that stabilize the channel surfaces. Once the roots have died and shrunk, these pores will be sufficiently large and stable to enable the roots of subsequent crops to penetrate.

Land may be left in fallow for 2–3 years for natural bush or forest vegetation to regenerate. Alternatively, planting selected species that are effective in regenerating soil structure can enrich the natural fallow. A cover crop may be sown to serve as a planted fallow. Promising cover crop species that have been shown to have potential as biological subsoilers are the grasses Bahia grass (*Paspalum notatum*), *Festuca elatior* (Elkins *et al.*, 1977), Guinea grass (*Panicum maximum*) (Lugo-Lopez, 1960), and alfalfa (*Medicago sativa*) (Meek *et al.*, 1992), pigeon pea (*Cajanus cajan*) and cowpea (*Vigna unguiculata*) (Maurya and Lal, 1979). Radish (*Raphanus sativus*)<sup>1</sup>, and the nitrogen-fixing shrubs *Tephrosia vogelii* (Plate 55), *Sesbania sesban* and *Gliricidia sepium* have also been identified as potentially useful (Baxter, 1995; Douglas *et al.*, 1999). Some weeds with pronounced tap-roots, such as *Amaranthus* sp., may possibly also have potential to act as biological subsoilers, as Mennonite farmers in eastern Bolivia have observed much higher crop yields on compacted soils after high infestations with *Amaranthus*.

Biological methods are generally much cheaper to implement and their benefits are longer-lasting than mechanical methods. An important advantage of vegetative fallows is that they greatly improve the physical, chemical and biological fertility of the soil due to the large quantities of organic matter produced and added to the soil. Tree fallows can be beneficial in supplying fuelwood, construction materials and other products, provided the harvesting of these materials does not reduce the beneficial effects of the fallow on soil chemical fertility.

The main disadvantage is the 2 to 3 years required for natural fallows when the land is taken out of production while the recuperation takes place. A disadvantage of tree fallows is the difficulty of returning to annual cropping after the fallow period because of the problem of extracting the tree roots and the longer the fallow period the more difficult the problem. However, the extraction of the roots of *Sesbania* after 2 years of fallow has not been a problem in Zambia. It is also necessary to protect the vegetation from grazing, burning and harvesting during the 2–3 year fallow period, which may involve additional costs for fencing.

Planted fallows of cover crops with tap-roots may be difficult because of the lack of available seeds and their cost, since a high plant population is necessary to ensure an adequate density of tap-root penetration of the root-restricting layer. For very dense root-restricting layers, even *Cajanus cajan* may have only a limited effect<sup>2</sup>.

<sup>1</sup> Benites, 2000. pers. comm.

<sup>2</sup> Observations of the author. See also: Barber, R.G. and Navarro, F. 1994. The rehabilitation of degraded soils in eastern Bolivia by subsoiling and the incorporation of cover crops. *Land Degradation and Rehabilitation*. 5: 247-259.

### Conditions favouring the adoption of biological methods

The use of natural biological methods will be favoured by farmers who have sufficient land. They can take some of it out of production and place it into fallow while the slow process of natural regeneration of soil porosity takes place. The use of cover crop fallows is often a rapid process which enables land to be more quickly returned to production. Natural fallows in which there is a regeneration of tree vegetation are more likely to be adopted by farmers who wish to change the land use of the recuperated area to forest or perennial tree crops.

### Mechanical solutions to physical root restriction

The aim of mechanical methods is to break-up the compacted or naturally dense root-restricting layer in order to create larger pores through which crop roots can penetrate. This is accomplished by the implement slightly lifting and breaking the compacted or dense layer. The operation may be carried out over the whole of the field, or merely along the rows where the crop is to be planted. The latter, known as in-row subsoiling, is much quicker and requires less draught power, but the crop must be sown with precision directly over the loosened rows. The most appropriate method will depend on the depth to the root-restricting layer, its thickness and hardness, and the source of power available.

### Mechanical disruption of shallow root-restricting layers

Shallow root-restricting layers such as hoe pans are typically produced at 5 to 8 cm depth, and the easiest means of breaking them up are with ox-drawn rippers or tractor-mounted chisel ploughs. Most farmers relying on manual tillage will probably have to use hand tools to break the hoe pans by methods such as double digging, which are very labour-intensive (Box 5). To break-up compacted layers in the dry season when the soil is very hard may require robust tools different from those the farmer normally uses for tillage, such as pickaxe, mattock, three-tined hoe (jembe) or a long crowbar.

In central and western Kenya, small resource-poor farmers intensified their production, both in yield and diversity, by using double-dug (to 50 cm depth) composted beds on small areas, generally near to their houses. Positive results were achieved from the concentration of organic materials onto the beds, which received focused attention, plus improved rainwater capture (Plate 56). Improved conditions in the root zone, including excellent moisture-holding capacity, enabled a range of vegetables (and field crops) to be grown well into the dry season, and these were less affected by drought than those grown in unimproved plots

While the total area of land managed in this way is often only a small proportion of the total cropped land, overall output from the beds rose sharply due to higher yields and diversification

#### Box 5: DOUBLE DIGGING PROCEDURE

1. Mark out a strip of land not more than about 9 metres in length and 120 cm wide, and divide it into segments about 60 cm long.
2. Starting at the first segment, loosen the topsoil to one hoe depth, and mix in compost if desired.
3. Transfer the loosened topsoil to an area just beyond the first segment outside the strip.
4. Dig the subsoil of the first segment to beyond the depth of the hoe pan to loosen it thoroughly.
5. Loosen the topsoil of the second segment to one hoe depth and mix in compost if desired.
6. Transfer the loosened topsoil from the second segment and place it over the loosened subsoil of the first segment.
7. Repeat the process following steps two to six until the whole strip has been double dug, and transfer the loosened topsoil from the first segment over the loosened subsoil of the last segment.

Regional soil conservation unit (RSCU/Sida)  
and  
UNDP/Africa 2000 Network/Uganda, 1997



**PLATE 56**  
**Double-dug composted beds with a**  
**crop of *Capsicum* – Kerugoya, Kenya**  
*[Association of Better Land Husbandry]*

of crops. The system provides many benefits which were recorded during a survey of farm families' comments (Box 6).

### **Mechanical disruption of moderately deep root-restricting layers**

Deeper root-restricting layers such as plough pans are formed at the lower limit to which the soil is tilled, and usually occur within the upper 10 to 25 cm of the soil profile. Plough pans formed by ox-drawn implements can usually be broken up using two passes of an ox-drawn ripper, whereas those formed by tractor-drawn or -mounted implements usually require a tractor-mounted subsoiler or paraplow (Plates 57 and 58).

Paraplows are similar to subsoilers except that the shanks are slanted sideways to the direction of travel, which enables soil to flow over the shanks (Figure 17). They are preferable to subsoilers as they bring fewer subsoil clods to the surface, require less draught power and cause less incorporation of surface residues that should ideally be left on the surface. Disc ploughs are less

#### **Box 6: BENEFITS OF DOUBLE-DUG COMPOSTED BEDS IN KENYA**

If in 1992, a planning team had decided that the targets for their small farmer rural development project were, by 1996 to boost self-sufficiency in maize from 22 to 48 percent of farmers; to reduce experience of hunger from 57 to 24 percent of farmers; and to reduce the proportion of farmers buying vegetables from 85 to 11 percent and increase the number selling to 77 percent, they would have been dismissed as utopian – yet it has happened.

Almost all adopters are very satisfied with the improvement in diet that has resulted from the abundance of vegetables that is the most obvious result of the adoption of conservation farming.

Adopters are well aware that the new diet is nutritionally better balanced than the old one and that this is important in relation to health, especially of children. This result is of particular significance to the NGOs, most of whom saw the elimination of child malnutrition - especially kwashiorkor - as a prime reason for promoting conservation farming.

Many adopters are very satisfied with the way that the new cash income from the sale of vegetables not only allows purchase of maize and other foods but also meets essential household needs such as school fees. Gross incomes of 1 400 to 3 000 shillings per year are possible from one double-dug bed (at date of report 85 shillings = £1 sterling).

A surprising finding is the extent to which adopters have extended organic matter management, notably compost, beyond the kitchen garden to the maize fields, even in tea-growing areas. This refutes the commonly held assumption that conservation farming is exclusively concerned with vegetables in the kitchen garden and explains the improvement in maize self-sufficiency.

It is encouraging to find that a group of 100 adopters will nearly double to 185 or so in just 3 years (despite dropouts) as a result of between-farm diffusion. Even more promising is the finding that most of this increase will be owing to spontaneous adoption by neighbours, who are impressed by what they see. What so impresses the neighbours and the adopters themselves is the profusion of healthy green vegetables growing on composted double-dug beds.

(after Hamilton, 1997)

**PLATE 57**  
**Subsoiler used to break-up naturally occurring dense horizons or compacted layers caused by tillage**  
 [R.G. Barber]



**PLATE 58**  
**The use of tractors with steel-rimmed wheels and metal fins to subsoil dense root-restricting layers is likely to be counterproductive because of the compacting effect of the metal wheels and fins – Santa Cruz, Bolivia**  
 [R.G. Barber]

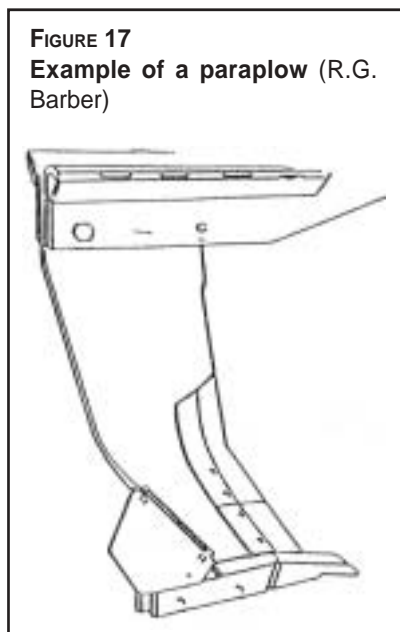

suitable because they invert the soil, incorporate most of the crop and weed residues and bring subsoil clods to the surface, resulting in the need for additional tillage.

If the root-restricting layer is to be disintegrated over the whole field, then as a rule of thumb the subsoiler or paraplow should penetrate to 1.5 times the depth to the lower limit of the root-restricting layer, and the spacing of the shanks should not be greater than this value. For example, if the root-restricting layer occurs at 10-24 cm depth, the shanks of the subsoiler or paraplow should penetrate to 36 cm and the spacing between the shanks should be no more than 36 cm. If the shanks are more widely spaced, there is a likelihood that the root-restricting layer will not be fully disrupted in the region midway between where the shanks passed. To avoid compaction from the wheels of the tractor, shanks should be positioned immediately behind the tractor's wheels. For in-row subsoiling, the shanks need only penetrate to the lower



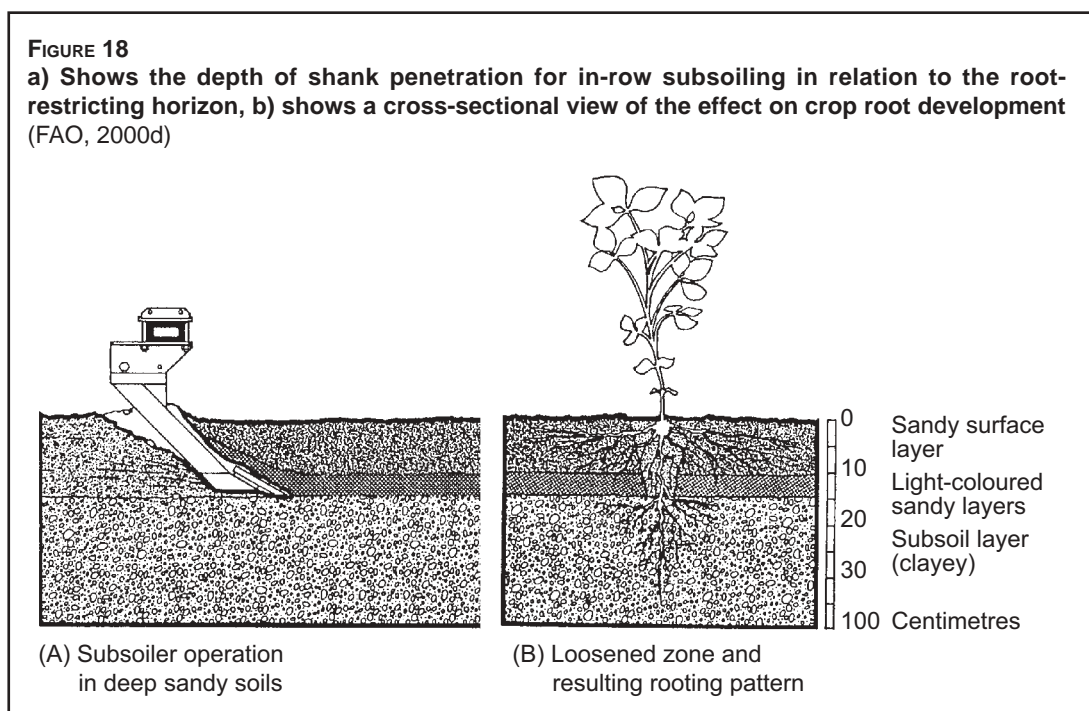

limit of the root-restricting layer, and the shank spacing should coincide with the planned row spacing of the crop (Figure 18).

Subsoiling should be carried out perpendicular to the normal direction of tillage and the soil should be dry to the depth of subsoiling to obtain good shattering. If the soil is moist or wet, there will be no shattering, merely the formation of channels gouged out where the subsoiler's points have passed. Further information on subsoiling procedures is given in FAO Land and Water Bulletin No 8 (FAO, 2000d).

### Mechanical disruption of very deep root-restricting layers in the subsoil

Subsoil compaction at 40 cm depth and greater is caused by the passage of very heavy equipment with high axle loads of at least 6 tonnes, such as combine harvesters and lorries laden with grain. At this depth the use of conventional subsoilers to loosen deep compacted layers is difficult and expensive because of the very high traction power needed. Vibratory and rocking subsoilers, in which the subsoiler points vibrate or rock using the tractor's power takeoff can work to 80 cm depth, but require 75–100 HP. New implements have been developed employing elliptically moving blades or rotary hoes, which utilize a break-off-loosening mechanism to disintegrate compacted layers. They can be used to depths of 60 to 120 cm and at higher soil moisture contents than conventional subsoilers, but are very expensive and require high traction power<sup>1</sup>.

The shattering and lifting of root-restricting layers by mechanical means creates larger pore spaces through which roots can penetrate, enabling them to reach and take advantage of soil moisture and nutrients stored in deeper layers. Consequently, crops are able to make more efficient use of the rainfall. The main effect of subsoiling is usually that of promoting deeper root growth, but if the root-restricting layers are so dense that rainwater movement is also limited, subsoiling may also facilitate the percolation of rainwater into deeper layers.

<sup>1</sup> Schulte-Karring, pers. comm. 1996.



The development of improved rooting frequently increases crop and pasture yields (Plate 59). In Babati District, Tanzania, breaking up hardpans by subsoiling has almost tripled maize yields and quadrupled maize dry matter production (Jonsson *et al.*, 1999). Increased yields from subsoiling are most likely in areas where yields are limited by rainfall, and the drier the season the greater the probable response to subsoiling (Box 7).

In-row subsoiling, especially when it is combined with planting in a single operation, is particularly beneficial for hardsetting soils that rapidly form root-restricting layers on drying after being saturated with rain. This technique is most likely to be successful when associated with precision planting and controlled traffic, in which the passage of all machinery wheels is restricted to permanent tracks. The benefits of subsoiling are likely to be greatest when immediately followed by the establishment of a dense cover crop with a strong rooting system that helps stabilize the new pore spaces created. The cover crop should then be followed by a system of conservation agriculture in which the absence of tillage reduces the recurrence of further compaction.

**Box 7: INFLUENCE OF SEASONAL RAINFALL ON SOYBEAN RESPONSES TO SUBSOILING**

An estimated 50 percent of the soils under mechanized annual crops in the central zone of Santa Cruz, eastern Bolivia are hardsetting soils, which suffer from restricted rooting due to the presence of naturally occurring very dense horizons lacking pores large enough for roots to readily penetrate. As a result yields are low, especially in seasons of low rainfall. Experiments have shown that the probability of subsoiling giving increased soybean yields was higher, the lower the seasonal rainfall. The average soybean response to subsoiling steadily increased from 0 percent at 760 mm seasonal rainfall to 90 percent for a seasonal rainfall of 44 mm. For 7 years out of ten, subsoiling gave 0 percent soybean response in the wetter summer season and 56 percent soybean response in the drier winter season, equivalent to a partial gross margin of US\$98 per hectare, excluding any possible residual effects.

Barber and Diaz, 1992



**PLATE 59**  
**Contrasting performance of *Brachiaria brizantha* in a compacted soil (left) and after subsoiling (right) – Las Brechas, Santa Cruz, Bolivia**  
 [R.G. Barber]

The principal disadvantage of mechanically breaking up root-restricting soil layers is the high power requirement, whether it is manual, animal or mechanical. Since most farmers do not have access to more than that which they use for land preparation, the process is inevitably slow.

Some soils become so extremely hard during the dry season, that the farmer's normal draught power is incapable of penetrating the soil in order to break-up the root-restricting layer. It is then necessary to wait for the beginning of the rains to moisten and soften the soil before it becomes possible to break-up the compacted layer, but this may coincide with the critical time of land preparation and planting. This problem can apply equally to farmers using animal traction or tractors and to those using hand tools as their source of power. Subsoiling operations are ineffective when the dense or compacted layers are wet or very moist as no shattering effect takes place.

Farmers often lack the necessary implements, whether they are pickaxes for farmers relying on manual power, rippers for animal traction farmers, or subsoilers or paraplovers for mechanized farmers. The use of normal land preparation implements will generally be less satisfactory. For example, disc ploughs can be used to break-up plough pans, but they invert the soil bringing large clods of subsoil to the surface and form an uneven surface that needs additional tillage to create a seed bed. Disc ploughs also incorporate the residues of crops and weeds, when ideally they should be left as a protective layer on the soil surface. Repeated use of disc equipment, especially heavy-duty disc harrows, can produce an almost impermeable compacted pan in only a few seasons. These pans have been the cause of increasingly severe runoff and erosion from millions of hectares in Brazil, before the use of disc equipment was abandoned in favour of minimum tillage with tines, and subsequently by no-till systems. When bulky crop residues are left on the surface, especially the stiff residues of maize, sorghum and cotton, the performance of subsoilers and paraplovers is considerably impaired unless they are fitted with front cutting discs.

If subsoiling is followed by conventional tillage, the beneficial effects are only likely to persist for 2 or possibly 3 years and so the subsoiling has to be regularly repeated. The speed with which the root-restricting layer reform will depend on the number of tillage and other field operations, the moisture content of the soil at the time of these operations and the susceptibility of the soil to compaction. Fine-sandy and silty soils and those with impeded drainage are most susceptible to compaction.

To improve the physical conditions of hardsetting soils requires the incorporation of large quantities of organic material into the dense layers and the regeneration process is likely to be slow. For hardsetting soils, in-row subsoiling may be necessary each year. These disadvantages can be overcome by adopting reduced tillage, or preferably zero tillage as in conservation agriculture, or by controlled traffic in which all machinery follows the same tracks year after year, leaving the cropped strips untouched. Thorough loosening of soils by subsoiling may render them more susceptible to compaction if they are subsequently subjected to high pressures, as from excessive tillage or the passage of very heavy machinery. The recompaction may be worse than the original state of compaction.

Subsoiling heavy textured soils, such as vertisols, can greatly increase the quantity of rainwater that reaches the subsoil, resulting in a marked reduction in the soil's bearing strength, i.e. its capacity to support heavy machinery. It should be noted that subsoiling to any given depth produces a high proportion of very large soil pores and fissures, a situation favouring better penetration of roots and of rainwater. It will not however produce any significant increase in the range of smaller soil pores, which make up the water-retention capacity of the soil.

### Conditions favouring the adoption of mechanical methods

The adoption of mechanical methods to overcome physical root restriction will be favoured where yields are frequently limited by low rainfall. Under such conditions it becomes important that as much of the rainfall as possible is stored within the soil profile, and that the crop's roots have access to all of the stored soil moisture. Mechanical methods will be favoured where farmers have access to tractors and subsoilers or paraplows, and where land cannot be taken out of production and put down to fallow for 2 to 3 years.

### Chemical solutions to restricted root growth

Root development is sometimes restricted by unfavourable soil chemical conditions, such as severe nutrient deficiencies, aluminium or manganese toxicity and salinity. The nutrient which most commonly restricts root development is phosphorus and the application of P fertilizers to phosphorus-deficient soils frequently encourages deeper rooting, enabling the crop to access more soil moisture and so increase productivity. The incorporation of lime without or with gypsum will reduce toxic concentrations of aluminium and/or manganese to non-toxic levels and so encourage deeper rooting. The greater solubility of gypsum compared with lime makes the former more suited to soils with aluminium or manganese toxicity problems in the subsoil, whereas the slowly soluble lime is most effective in topsoils. When high salt concentrations inhibit root development in irrigated soils, excess quantities of water should be applied sufficient to leach the salts out of the crop's rooting zone.

### MAXIMIZING USEFULNESS OF LOW AND ERRATIC RAINFALL

Several approaches may be used to diminish the impact of low and erratic rainfall, viz. match land use to soil characteristics; use drought-resisting and drought-escaping crops; increase the efficiency with which crops utilize rainwater; concentrate rainfall by water harvesting; divert river water; intercept floodwater; and apply supplementary irrigation.

### Match land use to soil characteristics

Matching land use to the most suitable soil types within a farm may increase the efficiency with which the available soil water in the different soil types is utilized for crop production. Crop water requirements vary, as do the capacities of soils to retain and supply water to crops. Moreover, the variations in available water capacities (AWC) of soils often occur

over short distances. Soils with high AWC will be expected to suffer less water loss from deep drainage and possibly from runoff. Consequently, greater quantities of rainwater will remain in the soil and so the potential crop-growing season will be longer assuming an adequate amount, distribution and infiltration of rainfall (Table 9).

**TABLE 9**  
**Length of growing period for different soil available water capacities in bimodal rainfall areas of semiarid India (Virmani, 1980)**

Rainfall probability	Length of growing period (weeks)		
	Low AWC 50 mm (Shallow alfisol)	Medium AWC 150 mm (Medium vertisol)	High AWC 300 mm (Deep vertisol)
Mean	18	21	26
75%	15	19	23
25%	20	24	30



PLATE 60

**Example of the matching of land use to land suitability based on differences in soil available water capacity and other land characteristics. From foreground to background: citrus, terraced vegetables, natural forest, grain crops, citrus and Eucalyptus woodlot. Chapecó, Brazil**  
[R.G. Barber]

The longer the expected duration of dry periods and the more sensitive the crop to drought, the more important it will be to use soils of high AWC. For soils to be considered suitable for maize in semiarid areas of Arusha, Tanzania, they must be of sufficient depth and AWC for the maize to be able to tolerate dry periods of up to four weeks (Jonsson *et al.*, 1999). Farmers can take advantage of variations in AWC by locating moisture-sensitive crops and crops with longer growing periods on soils of high AWC and crops tolerant to drought and early-maturing crops on soils of low AWC. This approach is applicable at farm level (Plate 60) and also at field level, especially for farmers with very smallholdings where differences in soil AWC between small areas within a field can still permit diversification. Some localized areas may occur within a field where runoff accumulates and provided the soil's AWC is adequate to retain the moisture, the soil will be suitable for more water-demanding crops.

Seasonally waterlogged low-lying, grassy areas, known as dambos, are commonly found at the head of watercourses in southern and central Africa. Their high soil water content makes them highly suitable for crop production, even in semiarid areas, because they are relatively unaffected by mid-season droughts. Even in dry years, yields up to 2.5 t/ha of maize can be obtained (Morse, 1996). Traditionally, dambos were used for rice, maize and vegetable production, dry season grazing and sources of domestic water. In Zimbabwe the cultivation of dambos was banned because of concern about environmental degradation, but recent research has shown that with environmental safeguards, present levels of yield could be increased threefold (Bell *et al.*, 1987).

Matching crops with weak root systems, such as beans, to soils lacking root-impeding layers, would be expected to increase crop water use efficiency. Beans are more suited to freshly tilled soils, or to mature no-tilled soils where large numbers of channels suitable for root penetration have been created through the decomposition of old roots and soil faunal activities (FAO, 2000e).

Allocating land use to suitable soil types may enable production to be intensified, leading to benefits in addition to that of higher water use efficiency. Thus, intensifying subsistence food crop production may liberate land for producing cash crops. Alternatively, it may allow land previously used for inappropriate, extensive and degrading forms of land use, to revert to natural vegetation, thereby reducing land degradation.

### **Use of drought-resistant and drought-escaping crops and varieties**

Some crops can tolerate drought because they are able to resist a shortage of water, i.e. they are said to be drought-resistant. This is because *either*:



- they can stop growing when water is unavailable by becoming dormant. When rain occurs they resume growing and developing as though nothing had happened; or
- they have deep rooting systems, such as pigeon pea, and can absorb water from deep within the soil. This is important where occasional rainstorms wet the soil to great depth followed by long dry periods.

Pineapples and sisal resist the effects of drought due to their thick leaves that slow down water loss by transpiration. These crops, as well as sorghum, pearl millet, pigeon pea, cassava, groundnut and cowpea, are drought-resistant and suited to climates with a defined mid-season drought.

Drought-escaping crops are those that can tolerate droughts because they have short growing periods and mature quickly before all the soil water has been used up. Early-maturing cultivars have been successfully bred in Kenya for dry areas, such as Katumani Composite maize and “Mwezi moja” beans. Cowpeas mature early and are both drought-escaping and drought-resistant (Squire, 1990).

A drawback of drought-escaping crops is that their short growing season restricts yields compared with long-season cultivars, although under dry conditions they will outyield the long-season cultivars. For example, improved pearl millet varieties in Tanzania, which mature two weeks earlier than farmers’ local varieties, have yielded 43 percent more (2.31 t/ha) than local varieties (1.62 t/ha) (Letayo *et al.*, 1996). Applying fertilizers to counteract nutrient deficiencies can speed up crop maturity and so enable them to escape droughts more easily.

Drought-escaping crops are more suited to short rainy seasons, or to soils which can only store a limited quantity of water. It is therefore important to select drought-escaping crops and varieties whose maturation period matches the expected length of growing season. If possible very determinate varieties should be avoided so that the risks of the whole crop being adversely affected by dry periods is reduced<sup>1</sup>. Unfortunately, farmers often do not have access to varieties that match the expected length of growing season, and the length of growing season may vary widely from year to year.

It must be borne in mind that the choice of crops and varieties depends not only on their ability to resist or escape droughts, but also on their susceptibility to pests and diseases, labour requirements, availability of seed, ease of grain processing (threshing, dehulling and grinding), fuel requirements for cooking, and palatability.

### **Increase crop water use efficiency**

Crop water use efficiency refers to the amount of dry matter produced for each millimetre of water that is transpired by the crop or evaporated by the soil, i.e. for each millimetre of evapotranspiration. Clearly, in dry areas the more efficient use the crop can make of the rainfall that infiltrates (referred to as the effective rainfall), the higher will be the yield. The following management practices influence crop water use efficiency:

### **Selecting water-efficient crops**

A group of crops referred to as C<sub>4</sub> crops, which include maize, sugar cane, sorghum and pearl millet, are physiologically much more efficient at producing dry matter for each millimetre of

<sup>1</sup> P. Craufurd, pers. comm. October, 2000.



transpired water than other crops, referred to as  $C_3$  crops. But this distinction is most important in situations where rainfall is adequate. For areas where water deficits are common, the use of drought-resistant and drought-escaping crops is much more important.

### **Adjusting plant population to expected rainfall**

A high plant population will use large amounts of water for transpiration during early growth provided sufficient water is available in the soil. Because of rapid shading of the soil by the crop foliage, less water will be lost by direct evaporation, ensuring a higher water use efficiency compared with low plant populations. High plant populations, and especially those with a more square planting arrangement, also increase water use efficiency through the quicker development of cover and therefore less weed growth.

Although evaporation losses are greater for low plant populations, soil texture and the frequency of rainfall events also influence the amount of water lost. Sandy soils in areas where rainfall occurs in few heavy storms will suffer less evaporation than medium or fine textured soils in areas with frequent rainfall events.

Where rainfall is erratic the situation is complicated, and becomes more than just a matter of water use efficiency. Farmers then face the dilemma of whether to sow at a low density to ensure some yield in bad years but underperforming in good years, or to use a high population to maximize yields in good rainfall years but to harvest very little, if anything, in bad years (Morse, 1996). If farmers have sufficient land they can opt for both options, i.e. an area with low population and another area with high population, but many small-scale farmers possess insufficient land for this to be feasible.

Response farming is an approach for matching crop management to estimated seasonal rainfall in variable rainfall zones (Stewart, 1988). Plant populations and N fertilizer applications are adjusted after the crop has been established on the basis of information about the expected rainfall. Initially, the crop is sown at a high population assuming a good rainfall season, and with a low application of N fertilizer. The expected potential of the season (good, fair, poor) is determined on the basis of the anticipated amount of rainfall during the first 30-50 days, derived from as many years' records as are available. Decisions are then made according to the amount of rainfall early in the season on whether or not to thin or to apply additional N fertilizer. So far, this practice has not been adopted by farmers because of the great variations in seasonal rainfall over short distances, because farmers usually intercrop, and because of the initial wastage of water that occurs if crops are thinned after 30 or more days (Morse, 1996).

### **Applying fertilizers**

Applying modest amounts of N and P fertilizers to soils lacking these nutrients is a very effective way of increasing the efficiency of crop water use in semiarid areas, so that more dry matter and grain are obtained from the same amount of rainfall (Gregory *et al.*, 1997). Phosphorus particularly helps in dry conditions by increasing root development and so enabling greater water uptake, whereas nitrogen tends to increase foliage production and hence transpiration in the presence of adequate water.

The effect of modest P fertilizer applications on sorghum yields and water use efficiency on P-deficient soils in Botswana is illustrated in Table 10. The efficiency of rainwater use and grain yield were greatly increased by P fertilization on deep soils, but not on shallow soils. This was presumably due to the low available water capacity of shallow soils, with greater rainwater losses by deep drainage.

Rotations with legumes can have a similar effect to the application of N fertilizers. The higher water use efficiencies of fertilized crops are largely due to increased growth and transpiration, causing greater shading of the soil surface and less water loss by evaporation (Squire, 1990).

**TABLE 10**  
Effect of P fertilizer and soil depth on rainwater use efficiency and sorghum grain yield in Botswana (Adapted from Morse, 1996)

	- Fertilizer		+ P Fertilizer	
	Grain yield (kg/ha)	Rainwater use efficiency (kg/ha/mm)	Grain yield (kg/ha)	Rainwater use efficiency (kg/ha/mm)
Deep soils	502	1.92	659	2.52
Shallow soils	378	1.53	362	1.47

*Values are the means of six tillage-planting treatments.*

Increasing soil fertility through fertilizer applications may also increase the speed of crop development so that crops mature earlier, and so become more drought-escaping. As an example, the addition of P fertilizer to very P-deficient soils in northern Syria accelerated the maturity of sorghum by two weeks, enabling the crop to mature while water was still available in the soil (Shepherd *et al.*, 1987). However, speeding up crop maturity can sometimes expose crops to water stress later on at a more critical growth stage (Morse, 1996).

### Weed control

Another important management practice for increasing crop water use efficiency and yields in areas with water deficits is weed control. Competition from weeds in pearl millet reduced yields by 25-50 percent in northern Namibia (Spencer and Sivakumar, 1986), and complete weed control in the USA increased the water use efficiency of sorghum by 10 kg/ha/mm (Clegg, 1996). Good weed control during the first 30 days is an essential practice if water use efficiency is to be maximized.

### Seed priming

Seed priming refers to soaking seeds in water before sowing to hasten germination and emergence, which leads to greater crop water use efficiency and higher yields. Soaking the seed for as little as 5-10 hours can reduce the time to emergence by 10 hours (LWMP, 1992), which may be crucial in enabling seedling roots to grow down to below a rapidly drying or crusting soil surface. For most crops soaking the seed for 12 hours is usually sufficient, but up to 24 hours are needed for rice and maize. Seed priming apparently does not work for finger millet (Village notes, 2000).

### Early planting

Early planting at the beginning of the rains has several advantages. It increases the chances of a crop reaching maturity before the rains end, and as a result of early growth shading the soil surface, evaporation is reduced enabling more water to become available for transpiration. This increases the efficiency of water use by the crop and so increases yields. These effects are also favoured by the flush of inorganic nitrogen and other nutrients liberated at the beginning of the rains from the decomposition of dead soil micro-organisms. Interaction between the additional nutrients and soil water enhances crop growth and yield. Crops planted early usually also benefit from less pest problems.

Farmers who rely on hand weeding prefer to allow the weeds to germinate at the first rains and only when the weeds have been controlled will they sow the crop. Some farmers favour staggered planting, as the different stages of growth of the crop will spread the risk of the crop suffering from drought at a critical stage of growth.

### **Accumulate moisture from one season to the next**

The amount of water in a soil available to crops can be increased in bimodal rainfall areas by keeping the soil in a clean-weeded fallow condition during the first season, in order to store rainwater for the next season. In this way the crop benefits from rainfall from two seasons, provided the water losses during the fallow period from weed transpiration, evaporation and runoff are negligible. There will be some inevitable losses by evaporation and probably by deep drainage. In some situations fallowing may be a feasible practice as it ensures a yield, but considerable labour is required to maintain the fallow free of weeds and to prevent serious weed problems the following season. Research from Zimbabwe has shown much higher yields after fallow than after the same or another crop, although the total yield as measured over a run of years was not significantly greater (Nyamudeza and Maringa, 1993).

Clean-weeded fallows are most feasible where extensive land areas are available and where weeds can be controlled mechanically. For these reasons it is regularly practised in large-scale highly mechanized systems in Australia and South Africa (Morse, 1996). However, the exposure of bare soils during the fallow period is not consistent with the principles of conservation agriculture and so is not a very desirable system. It will increase the loss of soil structure and organic matter and may give rise to serious erosion problems.

### **Water harvesting**

Water harvesting encompasses many different practices based on the utilization of runoff from uncropped areas to supplement the rain falling on cropping areas, or to store water for irrigation, or domestic or livestock use. Emphasis is placed on the use of runoff for crop production. Water harvesting practices are appropriate in semiarid and arid areas where droughts are common and irrigation is not feasible. If doubts exist about whether or not the seasonal rainfall is adequate for cropping, efforts should first be made to minimize rainfall losses from low infiltration and evaporation.

In situations where water harvesting practices are appropriate and practised, runoff is considered as a valuable resource. This is in marked contrast to the other water management systems considered in this Bulletin, for which the approach is to avoid runoff by maximizing infiltration and to encourage farmers to develop an aversion to runoff. Water harvesting methods may be separated into:

- *Runoff harvesting* which refers to the harvesting of runoff from bare or sparsely vegetated areas and its collection for use in cropped areas. These may be as small as single planting positions, as in the case of “zai” pits (see below). Two forms may be identified:
  - a) Sheet-flow runoff harvesting where runoff occurring as sheet-flow is collected from gently sloping land surfaces.
  - b) Concentrated runoff harvesting where runoff is collected from narrow channels such as footpaths, cattle tracks or transient streams in which runoff has been concentrated (Figure 19).

- *Floodwater harvesting* is the diversion of floodwater from watercourses for storage in farm ponds or microreservoirs.
- *Water spreading* which refers to the diversion of floodwater from watercourses for spreading over land that is to be cultivated (Figure 20).
- *Rooftop harvesting* which is the direct harvesting of rainfall from roofs, generally for domestic or livestock use (not considered further).

The capacity of the soil in the cropping or receiving area to retain runoff and rainfall is of crucial importance for crop production by water harvesting. Consequently deep soils and loamy textures, with high available water capacity, should be selected rather than shallow, sandy or very stony soils. There is little point in harvesting runoff for crop production if no attention is paid to the other aspects (chemical, biological and physical) of soil fertility. Substantial yield increases can only be obtained if nutrients are not limiting, so the addition of organic materials, manures, or fertilizers will often be essential. Good agronomic practices to control weeds, pests and diseases are also important.

Drought-resistant cereals, such as sorghum and millet, should be sown. Sorghum is particularly suited to water harvesting because it also tolerates temporary waterlogging. Legumes are much more susceptible to waterlogging, but should be encouraged when possible because of their ability to fix nitrogen. Suitable legumes in northern Kenya are cowpeas, green grams, black grams and pigeon peas. Chickpeas do well on black cotton soils (vertisols) (Thomas, 1997).

Social and land tenure factors are frequently very important in determining the degree of adoption of water harvesting practices. The labour required to construct the collecting areas and maintain bare runoff areas, the amount of land needed, the rights of individuals to the land and the feasibility of restricting grazing to avoid damaging the collection structures will often preclude their implementation. Successful implementation of water harvesting schemes is most often achieved when based on traditional water harvesting practices and when the whole community participates. More detailed information on the selection, implementation and

**FIGURE 19**  
**Example of concentrated runoff harvesting by diverting ephemeral flows into retention ditches or basins (Thomas, 1997)**

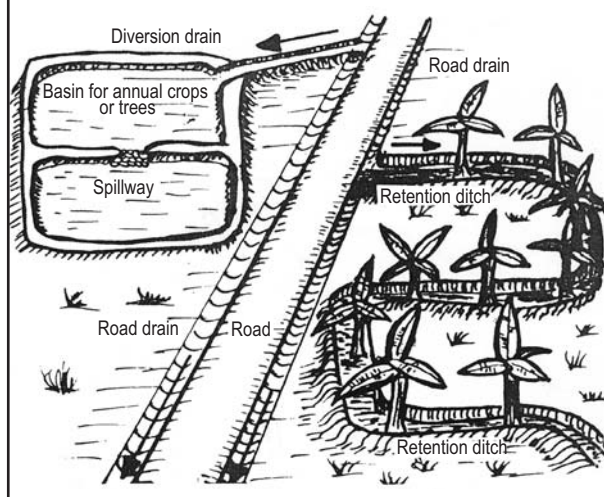

**FIGURE 20**  
**Permeable rock dams with contour stone bunds for floodwater harvesting and water spreading (Thomas, 1997)**

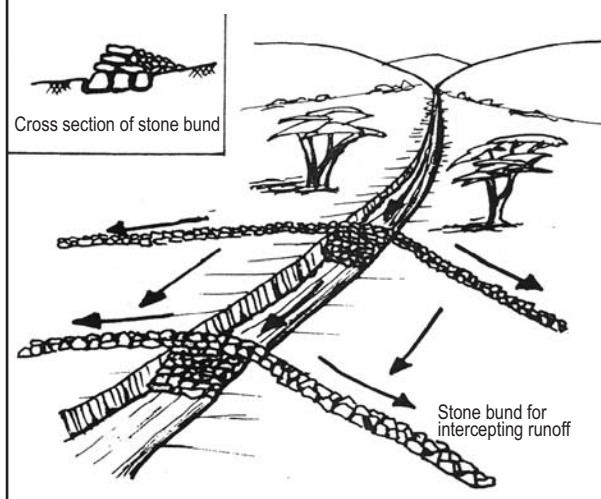

management of water harvesting systems is given in manuals by Thomas (1997), FAO, (1991), Pacey and Cullis (1986), TAJAS (1999).

In *sheet-flow runoff harvesting* systems sheet-flow runoff is collected from a larger catchment (collection) area and is concentrated into a smaller cropping area. The lower the rainfall and the more water needed by the crop, the greater should be the catchment area compared with the cropping area. For catchment areas less than 10 metres, the ratios of catchment to cropping area generally vary from 1:1 to 3:1.

It is recommended that the slope of the catchment area does not exceed 5 percent in sheet-flow runoff harvesting. Bare catchment areas yield most runoff, but work is needed to maintain the land in this condition. In many situations catchment areas are left under natural vegetation and may sometimes be sown to short-season crops, but the efficiency of runoff generation will be considerably less. Diversion ditches may be necessary upslope of the area used for runoff harvesting to prevent excessive runoff damaging the water harvesting structures. There are many variations in the form and design of water catchment structures, but essentially they are pits, ditches or basins, or formed by earth or stone barriers. Concentration of runoff into smaller areas encourages deeper percolation of rainwater into the soil from where it is less susceptible to loss by evaporation. This increases the efficiency of crop water use and raises productivity.

The results of water harvesting compared with traditional cropping systems are very variable. In dry seasons yields can increase by as much as 300 percent compared with yields without runoff harvesting, but in wet seasons yields are likely to be reduced because only part of the land is cropped, or because waterlogging in the cropping areas has reduced yields (SUA, 1993). The adoption rates of runoff harvesting are often low because of the following factors (Morse, 1996):

- farmers' reluctance to maintain clean weeded runoff areas;
- high costs or labour requirements for constructing and maintaining pits, ditches and barriers;
- farmers' reluctance to crop only a fraction of the field as the productivity gain may not compensate for the higher yields obtained from the whole field in good rainfall seasons;
- farmers have limited available land;
- land is used for communal grazing which can damage the water retention structures.

Other adverse features of runoff harvesting are:

- risks of crops suffering from waterlogging in the cropped areas from excess runoff;
- high risks of erosion and other forms of soil degradation in the runoff catchment area;
- the greater the quantities of runoff harvested, the higher the risk of serious erosion problems;
- risks of collapse of barriers and infilling and overflowing of pits and ditches from heavy rainstorms, and of breaching of earth barriers by rodents or by the formation of cracks during clay shrinkage.

The following examples of water harvesting are mainly from the Soil and water conservation manual for Kenya (Thomas, 1997).

### **Zai pits or Tassa**

This is an example of one of the many traditional forms of planting pits practised in the arid and semiarid zones of the Sahel (FAO, 1996a). Zai pits, about 15 cm deep, 40 cm in diameter



**PLATE 61**  
**Zaï pits or Tassa, for water harvesting**  
 – Illela, Niger  
 [C.P.Reij]



and spaced every 80 cm, are constructed during the dry season by digging out the soil and placing it on the downslope side (Plate 61). Stones may be placed on the upslope side of the earth around the pits to help control runoff. Termites quickly attack organic residues that are blown into the pits and the formation of termite galleries from the surface of the pit deep into the subsoil encourages rainfall infiltration. Two weeks before the rains, one or two handfuls of dry dung (1-2.5 t/ha) are applied to the bottom of the pits and covered with earth. Millet is sown in the pits when the rains begin, and some runoff from the crusted soil surface upslope of the pits runs into the pits. The millet sends roots deep into the bottom of the pits where they find stores of water and nutrients recycled by the termites.

Zaï pits enable farmers to use small quantities of rainwater, manure and compost very efficiently and rapidly restore the productivity of degraded lands (Hassane *et al.*, 2000). They are recognized as the most cost- and time-efficient technique for rehabilitating very degraded lands in the Sahel, and are

an excellent means of establishing tree seedlings so that agroforestry practices can be introduced (Ouedraogo and Sawadogo, 2000). In Tigray province, Ethiopia, infiltration pits have tripled crop yields (Abay *et al.*, 1998). The main constraints to Zaï pits are the labour needed to construct the pits in the dry season and the scarcity of manure. In Mali, yields of sorghum on test plots treated with improved *zaï* were far higher than on control plots with the conventional flat-planting method (Table 11).

Similar effects of improved *zaï* have been noted by farmers in Burkina Faso (Ouedraogo and Kaboré, 1996):

- by concentrating rainfall and runoff, crops are less susceptible to dry periods within the rainy season;
- economizes on scarce manure by concentrating its use at planting positions;
- encourages reintroduction of soil fauna (termites, etc.), which improves soil structure;
- because land can be prepared well in advance, planting can take place on time;
- enables rehabilitation of badly degraded land (important where there is large population pressure on land);
- possible to get a yield even in the first year and generally higher than yields obtained from fields already under cultivation;
- contribute locally to replenishing the groundwater table.

**TABLE 11**  
**Effects of improved *zaï* on sorghum yields over 2 years**  
 (Wedum *et al.*, 1996)

Season	Crop	Yield with <i>zaï</i> kg/ha	Yield conventional method kg/ha
1992–93	Sorghum	1 494	397
1993–94	Sorghum	620–1 288*	280_320*

\*= Optimum sowing date

A study in Niger on yields and farmers' returns to labour in a "wet" year (1994–613 mm) and a "dry" year (1996–439 mm), compared yields of millet from the traditional planting procedure without planting pits (T0) with the use of *tassa/zaï* or *demi-lunes* (larger, half-moon-shaped), each with manure alone (T1), or with manure and fertilizer (T2) (Table 12).

The yields achieved by early adopters on only 4 ha in 1989 encouraged others to try, and the method spread rapidly to about 3 800 ha by 1995 and has continued to increase since.

**TABLE 12**  
**Yields, net value of production and returns to labour from existing *tassa/zaï* and *demi-lunes*, Niger**  
(after Hassane *et al.*, 2000)

	<i>Tassa/zaï</i>			<i>Demi-lunes</i>		
	T0 No <i>tassa</i> (av. yield of District)	T1 <i>Tassa</i> + manure	T2 <i>Tassa</i> + manure + fertilizer	T0 No <i>demi- lunes</i> (av.yield)	T1 DL + M	T2 DL + F + M
<b>Year 1994</b>						
Yield of millet (kg/ha)	296	969	1 486	206	912	1 531
Net value production (CFA)	22 680	70 020	99 380	15 480	65 460	111 980
Returns to labour (CFA/day)	756	737	946	516	569	896
<b>Year 1996</b>						
Yield of millet (kg/ha)	11	553	653	164	511	632
Net value production (CFA)	100	47 800	45 800	15 400	43 600	52 700
Returns to labour (CFA/day)	3	869	705	513	872	878

### Half moons (demi-lunes)

Sheet-flow runoff is collected from catchment areas of 10 to 20 m<sup>2</sup> areas by banks of earth constructed in the form of half moons 2 to 6 metres wide, which are constructed along contour lines in an offset arrangement (Plate 62) The spacing between contour lines will depend on the required ratio of catchment to cropping area. In Ouramiza in Niger, 20 cm deep half moons are 2 m wide and set at 4 m intervals along the contour, with a 4 m spacing between contours (FAO, 1996a).

The half moon bunds guide runoff into their centre where it accumulates in pits, and excess runoff can escape around the ends of the half moons. For tree establishment the pits may be 60 cm deep and 60 cm square. Half moons may be planted to grain crops, forage grasses or trees, with the tree seedlings planted just above the pit or just below the bund to avoid waterlogging. Half moons are usually made by hand. Consequently their construction requires considerable amounts of labour. A further disadvantage for millet and some trees is that the large amounts of sediment deposited within the half moons form fairly impermeable crusts, which can impede emergence.

### Contour stone lines

Contour stone lines refer to a single line of stones placed along the contour, whereas stone bunds are built up of stones to a height of 25 cm and about 35–40 cm wide. The base may be set in a shallow trench 5–10 cm deep to prevent the stones being swept downhill by the runoff. Bunds are permeable but slow down runoff, and by positioning smaller stones on the upslope side and larger stones on the downslope side, some sediment is filtered out and deposited behind the bunds. With time there can be a slow development of terraces. Spacing of the lines and bunds is generally 15–30 m.

**PLATE 62**  
**Examples of half moons for water harvesting – Illela, Niger**  
[C.P. Reij]



Stone bunds have been very effective in Burkina Faso and Ethiopia for crops and rangeland rehabilitation. On slopes of 1–3 percent stone lines at 25 m spacing have doubled sorghum yields and reduced runoff by 23 percent (Zougmore *et al.*, 2000). In some parts of Burkina Faso the stone bunds are constructed so as to be continuous with permeable rock dams created across gullies, which divert water from the gully and spread it over the land.

### **Contour earth ridges and bunds**

Contour earth ridges are generally 15–20 cm high, constructed parallel to the contour and spaced 1.5 to 3 m apart, and have been found to be technically successful for producing crops and trees. They are constructed by digging a furrow along the contour and throwing the soil on the downslope side to form ridges. Prior cultivation of the land beneath the ridges promotes the binding of the ridge to the soil below. Cross ties are constructed in the furrow every 4–5 m to prevent runoff from accumulating at the lowest point and overtopping or breaking through the ridge. Sorghum or bulrush millet is often planted on both sides of the furrow, with the land between the ridges being left bare to encourage runoff generation.

Contour earth bunds are large ridges, at least 20–40 cm high, constructed with a road grader or tractor and plough. The bunds are spaced every 5 to 10 m and cross ties are constructed at 10 m intervals. The ridges should be rebuilt every season, and can be periodically moved downslope for a short distance to ensure a fresh supply of nutrients. Earth bunds may be faced with stones positioned on the upslope side. Earth ridges and bunds only work well when the soil is reasonably permeable so that infiltration can occur. If the soil is compacted or naturally impermeable, the buildup of water behind the ridge or bund can cause collapse or overtopping, resulting in the loss of water and soil erosion.

Another essential requirement is that the ridges or bunds do not form cracks and are sufficiently stable that they do not collapse when wetted by the runoff. Earth bunds have been successfully used for establishing trees at about two metre intervals together with grasses in denuded lands. The grasses assist in stabilizing the bunds. Although they have been technically successful, adoption by farmers without assistance in northern Kenya has been limited (Thomas, 1997).

### **Retention ditches**

The most common and successful concentrated runoff harvesting practice in Kenya is the harvesting of road runoff in retention ditches. These are usually about 50 cm deep, 50 cm wide, and constructed along the contour. The excavated soil is either thrown uphill to form an enlarged fanya juu terrace, or downhill as in a cutoff drain. The base of the ditch is usually level, but may

be graded to allow water to flow from one end to the other. Retention ditches are often used for bananas. Since bananas need large amounts of water and can tolerate temporary waterlogging, it is only necessary for the ditches to be large enough to retain the expected runoff. Alternatively, a spillway should be constructed so that excess water can escape without causing damage.

### **Retention pits**

Small retention pits (or microcatchments) of 0.5 to 2 m<sup>3</sup> capacity and lined with concrete are being investigated by farmers and researchers in Honduras for harvesting runoff from patios, footpaths and natural temporary waterways (Lopez and Bunch, 2000). The aim is to use harvested water for supplementary irrigation or for extending the cropping season.

### **Retention basins**

Retention basins collect the runoff from roads, footpaths or transient streams. They may be rectangular or square, surrounded by small earth bunds and located adjacent to individual bananas or trees. Small basins may be used for individual trees or range reseeding, and larger basins for annual crops or small woodlots.

The *Majiluba system* is an example of traditional retention basins, which are extensively and successfully used by farmers in the semiarid lowlands of the lake zone of Tanzania for paddy rice cultivation (Gowring, pers. comm. 2000, and Morse, 1996). The main sources of runoff are ephemeral streams, paths and residential areas and the runoff is diverted into paddy-fields with earth bunds in the bottoms of the valleys. The grass *Cynodon dactylon* protects the bunds of the retention basins. This system requires collective organization by the community.

### **Farm ponds**

Harvesting runoff from concentrated flows and storing it in farm ponds of 150 to 300 m<sup>3</sup> capacities is being investigated in Burkina Faso and Kenya (Rockstrom, 1999). The aim is to use the harvested water for the supplementary irrigation of staple grain crops.

### **Floodwater harvesting and water spreading**

Floodwater harvesting and water spreading refer to the utilization of water from watercourses (Thomas, 1997). There are two approaches: interception of floodwater behind large bunds with stone spillways in the floor of a flat valley so that the water is retained and spread laterally, and diversion of spate flow from an ephemeral watercourse, over adjacent land.

Temporary structures such as bunds are used to divert water from a watercourse and guide it over the land to be cultivated. Alternatively, the water is diverted into a series of basins, the water passing from basin to basin through spillways. The main problems are the unpredictability of floods, the dangers of structures being washed away, and the uneven depth of the spread water.

## **COLLABORATIVE STAKEHOLDER PARTICIPATION**

A participatory approach should be adopted to ensure that the real causes of the problems are identified and that possible solutions are appropriate, feasible and acceptable to all concerned.

Participants should include representatives of the whole community that is affected by the problem, i.e. men and women, young and old, rich and poor. Representatives of government and private organizations who can contribute to the solution of the problems should also participate. These may include government and NGO extensionists, commercial agricultural suppliers, credit and marketing organizations and technical specialists in soil and water management, agronomy, irrigation and groundwater hydrology as appropriate. Annexes 1-6 provide information and suggestions on collaborative activities and the participatory approach.

### **Need for a facilitator**

An extensionist with whom the community is familiar should act as facilitator. It is the facilitator's responsibility to ensure that all participants have the opportunity to express their views and that no undue emphasis is given to the community's more prosperous and influential members. Further details of facilitators' roles are given in "Guidelines and reference materials on integrated soil and nutrient management and conservation for farmers field schools" (FAO, 2000a).

### **Need to tackle root causes**

To successfully resolve problems, the underlying root causes of the problem need to be identified and addressed. Failure to tackle the root cause would result in the symptoms of the problem being treated rather than the underlying cause, which would greatly diminish the chances of successfully resolving the problem.

### **Participatory identification and prioritization of soil water problems**

Evidence of crop water stress problems and their causes should be obtained from the field transects and soil pit examinations, using the indicators described and prioritized using a ranking method.

### **Participatory identification of the root causes**

The root causes of the crop water stress problems are discussed and identified in a participatory manner by developing a problem-cause tree, such as that shown in Figure 21. Problem-cause trees illustrate the relationships between problems, causes, and the causes of the "causes" in a logical hierarchical arrangement, with the observable problem at the top and the ultimate root causes of the problem at the bottom. The causes of the observable problem are usually themselves problems for which causes can be identified, and so the process continues until the root cause(s) is (are) identified.

To produce a problem-cause tree, participants are asked to write the immediate causes of the observable problem on cards. Those cards corresponding to the main and most immediate causes of the problem are arranged in a line immediately beneath the observable problem. These causes then in turn may be considered as problems. The process is repeated to obtain the most substantial and immediate causes of these problems, which are arranged in a line below the problem to which they correspond. After each line has been established the tree is discussed and any necessary modifications are made. The process continues until the root causes have been established and agreed. This procedure is useful for all types of problems. For example, in Figure 21, the root cause of runoff is identified as the lack of fodder for livestock in the dry season.



### Participatory identification of possible solutions for testing

Possible solutions are emphasized at this stage, as farmers will normally need to assess the suitability and appropriateness of solutions by carrying out simple trials to evaluate or validate them. Farmers will frequently need to adapt these possible solutions to their own particular farming, social, economic and environmental conditions.

Possible solutions are identified through participatory discussions that draw upon the experiences and suggestions of all participants. The problem-cause tree diagram is a useful framework for focusing thoughts and discussion on possible solutions to each of the causes or problems identified, starting with the root cause(s), and working up the tree. An example is shown in Figure 22. Technical specialists and the facilitator may also need to propose solutions to the problems (Table 13), but whenever possible emphasis should be placed on modifications of farmers' existing technologies. Visits to innovative farmers who have successfully adopted or adapted possible solutions are highly desirable, as this enables farmers to freely discuss their advantages and disadvantages.

The fact that each individual type of action may also have more than one effect is illustrated by a visual approach to matching possible solutions to soil water problems as given in FAO Soils Bulletin No.75, pp. 56–57 (FAO, 1999a).

### Participatory selection of possible solutions for testing

The possible solutions are discussed according to their suitability to the farming system and farmers' circumstances on the basis of the resources needed (labour, land, cash, on-farm materials and external inputs), their availability within the household or community, and other practical limitations. Some possible solutions will require changes to the farming system and household activities. For example, the introduction of silage (as a possible solution in Figure 22) may require silage crops to be sown on land that was previously used for food crops, and allocation

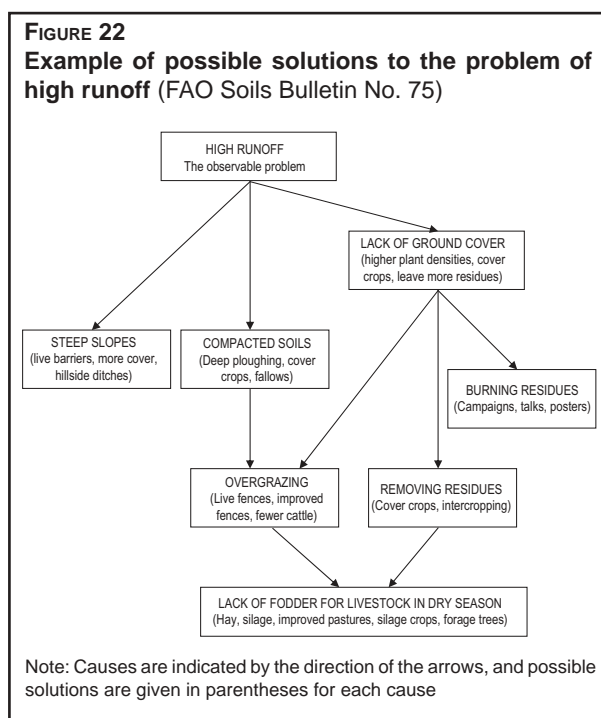
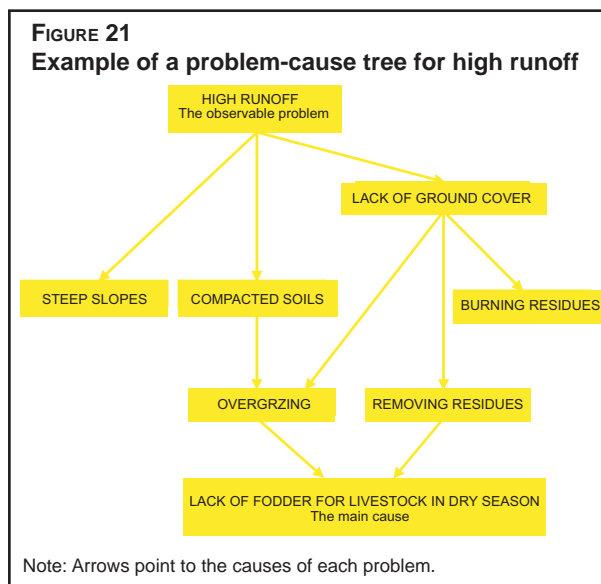

TABLE 13

Checklist of possible solutions to soil water problems that will need validating and adapting with farmers

Cause	Generic solutions	Specific solutions
<b>Restricted infiltration</b>		
a) Low porosity of soil surface	Protect soil surface and increase porosity of soil surface	<i>Conservation agriculture:</i> Soil cover (mulches, tree lopping mulches, crop/cover crop residues, etc.), minimum soil disturbance (minimum or zero tillage) and crop rotations including cover crops Natural, enriched and planted fallows Closure and protection of forests Temporary closure of grazing lands
	Increasing the period for infiltration	<i>Physical structures to detain runoff:</i> Contour field operations Narrow-spaced contour ridges and tied ridges Bench/orchard/platform/Fanya juu terraces Stone walls and earth bunds Trash lines Live barriers
b) Low subsoil permeability	Improve deep drainage	Deep tillage/subsoiling to loosen impermeable subsoil
	Construct backup physical structures to retain runoff	Fanya juu terraces Earth bunds
<b>High evapotranspiration</b>		
a) Soil water evaporation	Reduce soil water evaporation	Soil cover and no-till Conservation agriculture
	Encourage deeper percolation of rainwater	Tied ridges Zai pits Half moons
	Increase shading of soil surface	Conservation agriculture Mulches, cover crops, intercropping, etc. Closer plant spacing
b) Weed transpiration	Weed control	Residue cover Mechanical/biological weed management Herbicides
c) Excessive crop transpiration	Reduce wind impact	Windbreaks Soil cover and no-till Conservation agriculture
<b>Deep drainage of rainwater</b>		
	Enhance soil AWC	Conservation agriculture Add organic manures
	Accelerate root development	Early planting (also possible through conservation agriculture)
	Change land use	Introduce deep-rooted crops
<b>Restricted rooting</b>		
a) Dense soil layers	Increase subsoil porosity	<i>Biological methods:</i> Conservation agriculture, including specific cover crops for decompaction Natural, enriched and planted fallows
		<i>Mechanical methods:</i> Double digging Subsoiling In-row subsoiling
b) Poor soil chemical conditions	Improve chemical conditions of subsoil	Lime/gypsum to neutralise Al and Mn toxicities Fertilizers to correct nutrient deficiencies Leaching to remove salinity

Cause	Generic solutions	Specific solutions
<b>Low or erratic rainfall</b>		
	Adapt land use to climatic conditions	Match land use to soil characteristics Drought-resistant or -escaping crops/varieties
	Increase efficiency of crop water use	Adjust plant population Select water-efficient crops Weed control Fertilizer application Early planting Seed priming
	Conserving water in the soil	Conservation agriculture Soil cover (mulches, crop/cover crop residues, etc.) and no-till Water-conserving fallows
	Water harvesting	Contour stone lines and bunds Contour earth ridges and bunds Zai pits, half moons Retention ditches, basins and pits Farm ponds Half moons
	Water spreading	Divert spate flows Intercept floodwater
	Supplementary irrigation	Pitcher irrigation Subsurface pipe irrigation Low-head localized irrigation (e.g. drip)

of labour for collecting, making and distributing the silage. In this way the most promising possible solutions suitable for testing can be selected, and any changes required to the farming system or household activities can be identified.

### Participatory testing and evaluation of possible solutions

The final step is for farmers to test and evaluate the possible solutions that have been selected to assess whether they are technically, socially, economically and environmentally acceptable to the farmer, his or her family and the community. Because of the highly variable nature of soils, even within a limited area, it is important that several farmers from different parts of the community carry out the same test on their farms. In this way it is possible to avoid atypical or strange results being obtained from one or two locations where the soil type or management was exceptionally good or bad. Farmers should carry out the initial tests on a small area only.

The testing of possible solutions by farmers on their own farms, perhaps following in-field demonstrations of the validity of the most likely ones, under guidance by field staff in conjunction with researchers, also encourages farmers to become more innovative, which is considered to be the key to sustaining agricultural development, especially in areas with inadequate advisory services (Bunch, 1995).

## Chapter 5

# Conservation agriculture

### IMPROVING SOIL CONDITIONS

Concerns about soil erosion affecting soil productivity in rainfed areas have resulted in an emphasis on trying to stop negative effects on crop yields attributed to erosion and runoff. This has been attempted by putting cross-slope barriers in fields designed to catch or divert soil and water moving downslope. This approach has not been particularly successful either in halting the problems or in raising yields, resulting in disillusionment among farmers. Money has been spent to little effect and damage to land has not been stopped.

However, if the emphasis is shifted towards the soil as a habitat for roots and if soil loss and runoff are recognized as consequences of prior damage to soil porosity, a different perception emerges. This is based on more positive thinking which considers first the soil conditions that allow plant roots to function optimally, and then the improvements necessary to bring any current inadequate state of the root habitat to that desired condition. Land uses would ideally be cross-matched with variations in land suitability with respect to erosion hazard – i.e. the most protective forms of land use would be allocated to places with the highest hazards of erosion. However, especially for farmers with few resources and small farms, low yields of subsistence crops may dictate that they be planted on all land units irrespective of erosion hazard. In both situations however, improving soil conditions to meet the needs of plant roots will often greatly reduce problems of soil loss and runoff.

Key goals of improving and maintaining excellent soil conditions for and with roots include:

- increasing the reliability of plant production in the face of unpredictable variations in the weather and other hazards of the environment;
- reducing production costs and raising net returns to producers;
- increasing the quality of the land and its resilience to extreme weather conditions.

### Residue-based zero tillage in Brazil and Paraguay

On increasingly large areas of Latin America there has been a revolution in agricultural practice over the past 30 years. The adoption of zero tillage methods of crop production by large numbers of farmers provides convincing validation of the value of such conservation-effective forms of agriculture, in agronomic, environmental, economic and social terms. This is being achieved on farms whose sizes range from less than twenty hectares to thousands of hectares and in a wide range of ecological zones.

Conservation agriculture (CA), as defined during the First World Congress on Conservation Agriculture (1-5 October 2001)<sup>1</sup> promotes the infiltration of rainwater where it falls and its retention in the soil, as well as a more efficient use of soil water and nutrients leading to higher,

<sup>1</sup> For more information: [www.ecaf.org](http://www.ecaf.org).



PLATE 63

A forest litter of leaves and twigs – even of *Eucalyptus*, as here – which affords a protective cover to the surface, food for soil organisms and ultimately is a source of soil organic matter within the profile (with plant roots themselves)

[T.F. Shaxson]

PLATE 64

Disk tillage not only buries much of the crop residues but also can pulverize the soil and induce serious compaction immediately beneath the tilled layer – Cerrado, Brazil

[T.F. Shaxson]



PLATE 65

Both surface soil and seeds have been moved by runoff from an earlier storm and deposited in the channel of a broad-based conservation bank

[T.F. Shaxson]

PLATE 66

Broad-based conservation banks are supposed to control runoff and soil erosion – Tabatinga, Brazil

[T.F. Shaxson]





more sustainable productivity. It also contributes positively to environmental conservation. In many environments conservation agriculture can be considered the ultimate soil and crop management system. Conservation agriculture has been successfully implemented in both small-scale (Sorenson *et al.*, 2001) and large-scale (Landers, 2000) farming, where it has given economic benefits as well as improved water resources.

## HISTORY

Zero tillage has been successfully practised in the United States for several decades, with regular annual growth in the total area. In Latin America there has been an impressive rate of adoption and accelerating growth over the past two decades.

Brazil and Paraguay suffer erosive rainstorms of very high intensities during the southern summer, which result in severe damage year after year. On almost all cultivated land, soil tillage for crop production, often with heavy disk ploughs followed by disk harrowing, resulted in many problems. These included:

- loss of the porous organic covering of the forest floor where land had been cleared (Plate 63);
- pulverization of surface soil together with compaction of the subsoil layer (Plate 64);
- loss of organic matter from the upper soil layers by rapid oxidation from the exposed surface;
- loss of potential soil moisture as runoff;
- reduction in soil depth by erosion of topsoil, resulting in losses of seeds and fertilizers, and causing additional replanting costs (Plate 65);
- declining flow and drying-up of streams and rivers during dry seasons.

Downstream there were problems with eroded sediments clogging urban water purification plants, sedimentation in stream valleys and reservoirs, damage to bridges and roads. A common response was to construct conservation banks on the contour, such as broad- and narrow-based bunds to control runoff and soil erosion (Plate 66). However, they did not stop erosion occurring on uncovered soil. Infiltration of runoff was impeded by the severe compaction along the channel where it collects. The channel beds are probably the most compact lines in the entire field.

As time passed and the runoff and erosion problems continued, larger and larger banks were built, but without conspicuous success in halting the problem. Declining productivity and profitability on family farms resulted in collapsing net farm incomes, falling land prices and families leaving their farms for some other livelihoods.

In 1972 there were 500 hectares under residue-based zero tillage on one farm in southern Brazil. The technique spread slowly at first, because of scepticism and insufficient knowledge. There was a lack of appropriate equipment, suitable cover crops and weed control techniques. As the economic and technical advantages of residue-based zero tillage became apparent the rate of spread accelerated, largely as a result of farmer-to-farmer contacts. By 2001 in Brazil, there were more than 13 million hectares managed in this way (Figure 23).

In the State of Santa Catarina<sup>1</sup>, Brazil, residue-based zero tillage has been adopted on 400 000 ha by 1998-1999 within a programme to promote these systems. As a result, some or all of the improved practices were spontaneously adopted on a further 480 000 ha outside the formal

<sup>1</sup> 90 percent of the 100 000 farmers in the State have holdings of 10 ha or less.

remit of the project, from a base of 120 000 ha in 1993-1994 (World Bank, 2000). The State's small farmers have been ingenious in devising their own equipment and methodologies to fit zero tillage to their individual circumstances, together with governmental and non-governmental arrangements for their technical and institutional support (FAO, 2000b).

In Paraguay, zero tillage was first used in the late 1970s but was not widely adopted on mechanized medium and large farms until 1990. It had expanded to 20 000 ha by 1993, to 250 000 ha by 1995–1996 (FAO, 1997) and to 480 000 ha by 1997, which represents 51 percent of the total cultivated area of Paraguay (Sorrenson *et al.*, 1998).

**FIGURE 23**

**The growth of residue-based zero tillage in Brazil 1972–1999** (after Landers, 1998 and FEBRAPDP, 2002)

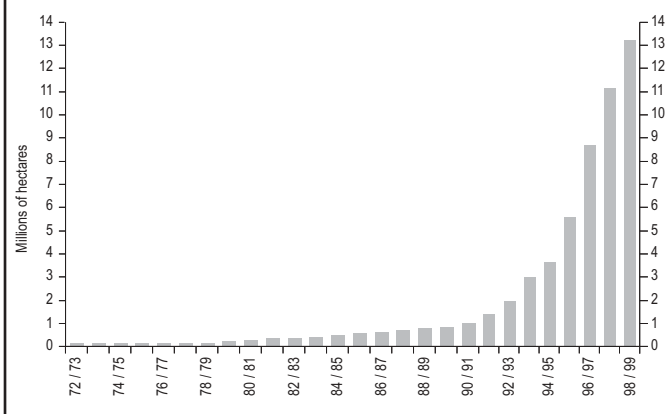

## IMPLEMENTING CONSERVATION AGRICULTURE

Planting a crop in the residues of the previous crop, which is the essence of conservation agriculture, is fast becoming a successful and sustainable cropping practice, especially in the subhumid tropics. Implicit in this practice is the absence or limitation of tillage practices that incorporate surface residues or disrupts soil porosity.

The quantity of crop residues produced is clearly very important and varies greatly with crop type, variety and yield. Invariably there are residues of weeds associated with crop residues that also contribute to soil cover, especially during the initiation of no-till. Large quantities of crop residues are usually obtained from sorghum, maize, rice, cotton and sunflower, whereas soybean, wheat and beans generally produce small quantities (Barber, 1994). Traditional varieties often yield greater quantities of residues than improved varieties, especially those of short stature and high harvest index. Most information on the optimum quantity of crop residues to be left on the soil surface is based on the amounts needed to reduce soil losses to acceptable levels on different slope gradients, rather than the amounts needed to maximize rainwater infiltration. Data exist showing that cover is less effective in reducing runoff than soil losses (Barber and Thomas, 1981; Lal, 1976), but there is little information on the influence of cover on infiltration and runoff, especially on 20 to 50 percent slopes, which are commonly cultivated by small-scale farmers. Usually, a minimum value of 70 percent surface cover – equivalent to 4-6 t/ha of maize straw for example – should be adopted.

The quantity of residues remaining during the cropping season is also influenced by the rate of residue decomposition. Nitrogen-rich legume residues, such as those from beans and soybean, decompose much more rapidly than nitrogen-poor cereal straw and other residues with high C/N ratios. On the other hand, legumes used as a cover crop can provide a weed-smothering cover, protection from raindrop impact, and important additions to organic matter (Plate 67). Harvesting procedures can drastically affect the quantity of residues remaining in the field.

The widely acclaimed success of conservation agriculture is mainly attributed to improved surface porosity (Plate 68) that results in increased infiltration and reduced runoff, and a

**PLATE 67**  
**Oilpalm undersown with a creeping legume – Anki Mabela, Fiji**  
*[Natural Resources Institute]*



**PLATE 68**  
**Soil conditions in a no-till system – Paraguay**  
*[T.F. Shaxson]*

greater water availability to crops. As additional benefits, conservation agriculture also lessens evaporation losses, reduces erosion, enhances earthworm activity and soil structure, improves soil fertility and lowers labour, machinery and fuel costs. With time, yields increase substantially provided crop rotations are well designed and include leguminous crops or cover crops. When compared with only applying a soil cover (mulches, crop or cover crop residues) in a conventional system, no additional time is required for land preparation in CA (apart from herbicide application in some cases), which allows earlier sowing and all the advantages that this confers. Consequently returns to labour are substantially increased.

There is evidence that the yield of a crop is significantly higher when sown directly into the residues of a previous crop than when it is sown in a previously tilled soil to which the same quantity of crop residues are applied as a mulch. This is attributed to the benefits of little soil disturbance: the soil structure created by the root channels from the previous crops as well as by the biological activity of earthworms and other soil fauna facilitate deeper rooting and enhance the infiltration and percolation of rainwater.

Conservation agriculture principles are implemented optimizing the soil as a dynamic habitat for roots as follows:

- Residues of crops and of cover crops are distributed evenly and left on the soil surface.
- Once the soil has been initially brought into good porous condition, no implements are used to turn over the soil, to cultivate it or to incorporate crop residues.
- Weeds and cover crops are controlled by slashing with a knife roller or by preplanting application of a non-polluting desiccant herbicide.
- A specialized planter or drill cuts through the desiccated cover, slotting seed (and fertilizer) into the soil with minimum disturbance.



**PLATE 69**  
A dense growth of nitrogen-fixing vetch  
within a zero tillage rotation  
*[T.F. Shaxson]*



**PLATE 70**  
Development of porous soil architecture  
beneath a grass crop in rotation  
*[T.F. Shaxson]*



**PLATE 71**  
Scarifying the soil with tines to a depth  
of about 30 cm to break-up a subsurface  
compacted layer and let in more of the  
rainwater – Apucarará, Brazil  
*[T.F. Shaxson]*

**PLATE 72**  
Interplanting maize in furrows drawn  
through a young cover of a low-growing  
vetch; in the foreground is soil which has  
been scarified – the earlier alternative.  
Caxambú, Brazil  
*[T.F. Shaxson]*





- Crop rotation is fundamental to zero tillage. It promotes adequate biomass levels for permanent residue cover and assists in control of weeds, pests and diseases. Rotations also ameliorate soil physical conditions, recycle nutrients and can fix atmospheric nitrogen. In semiarid conditions, appropriate crop rotations involving deep-rooting crops can also make still better use of residual soil moisture.
- As a result, soil erosion is reduced by about 90 percent and soil biological diversity maximized (adapted from Landers, 2000)

In such systems soil damage is reduced and recuperation of soil architecture is much more quickly achieved than by unimproved fallow systems. Appropriate crop rotations are as important as the soil cover and no-tillage practices (Plate 69). Grasses, in particular, increase the aggregation and stability of soil particles which provide a range of small voids resulting in increased porosity (Plate 70).

Residue-based zero tillage is implemented gradually on structurally damaged soils. At the start, tillage with tined equipment (scarification) can be used to break up the underlying pan and let more rainwater back into the soil, while leaving some of the plant remains on the surface (Plate 71). In this way the soil is opened up and the previous crop's residues are incorporated. It may necessary to start renovating the soil by enabling more rainfall to become soil moisture, but too frequent scarification can also damage soil architecture because of the shattering effect on soil structural units.

Following the break-up of the underlying pan, strip cropping with a legume between rows of the main crop (e.g. maize) could be carried out (Plate 72). Finally a complete cover of crop residues without further soil disturbance by tillage could be established (Plate 73). The residues change overtime from being a protective cover to becoming an integral component of the soil (Plate 74). In the process, the worms and other soil mesofauna burrow within the soil seeking food and thereby provide channels and biopores through which air and water can move easily.

## EFFECTS OF CONSERVATION AGRICULTURE

### Effects on crop yields

Farmers' own experiences confirm what was anticipated by results of two six-year experiments with wheat and soybean between 1978 and 1984, comparing effects of conventional tillage, minimum tillage/scarification and zero tillage (Table 14).

### Effects on soil moisture

It might be expected that zero tillage would be no better than scarification (opening large spaces in the soil and leaving a rough surface) in increasing moisture in the soil, but this is

TABLE 14

Yields of wheat and soybean, averaged across rotations, under three different soil preparation methods in Londrina, Brazil (Derpsch *et al.*, 1991)

Year of harvest	Conventional cultivation Disk equipment		Minimum tillage Scarification with tines		Zero tillage	
	t/ha	Relative	t/ha	Relative	t/ha	Relative
Wheat (t/ha)						
1978	1.36	100	1.28	94	1.81	133
1979	1.60	100	1.67	104	1.84	115
1980	2.25	100	2.24	99	1.97	87
1981	0.72	100	0.99	137	1.12	156
1982	0.39	100	0.48	122	0.86	220
1983	1.72	100	1.84	107	1.98	115
Mean yield	1.34	100	1.42	106	1.60	119
Soybean (t/ha)						
1979	1.43	100	1.50	105	1.99	139
1980	2.51	100	2.85	114	3.09	123
1981	2.03	100	2.16	106	2.86	141
1982	1.34	100	1.23	91	2.03	151
1983	1.45	100	1.53	105	1.90	131
1984	1.60	100	1.85	116	2.00	125
Mean yield	1.73	100	1.85	107	2.31	134

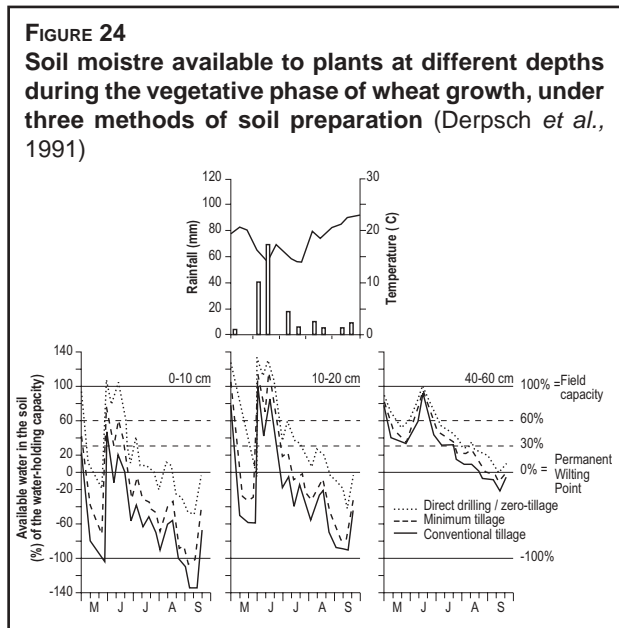



**PLATE 73**  
**Zero-till maize planted in a narrow slot cut through the residues of the previous crop of wheat by a pair of sharp disks – Mauá, Brazil**  
 [T.F. Shaxson]



**PLATE 74**  
**In the same field, note the dark decomposing wheat residue materials (left-hand side of photo) beneath the light-coloured surface straw – Mauá, Brazil**  
 [T.F. Shaxson]



not the case, as shown in Figure 24. This shows changes in levels of soil moisture under wheat, at three depths, under conventional soil preparation, scarification (minimum tillage) and zero tillage, during the crop’s vegetative stage in the 1981 growing season. Plant-available moisture was greater and water stress, due to drought, shorter under zero tillage than under the other methods.

Plate 75 shows the differences in the soil physical conditions from a residue-based zero tillage system and conventional tillage system on the same soil type. Other experimental work showed that where the cover of residues was similar, the percentage of rainfall which infiltrated into scarified

and zero-tilled soil differed by only 2-3 percent (Derpsch *et al.*, 1991). Nevertheless, Figure 24 shows a disproportionate benefit to zero tillage in terms of amount of soil moisture and duration of its availability to the plants. This reflects differences in pore space distribution within the soil architecture between scarification and zero tillage.

The fact that differences in the three-dimensional arrangement of the root habitat contribute to differences in root growth and function, even though soil moisture conditions may be almost

**PLATE 75**

This farmer has studied the comparative effects of zero tillage – on the left – vs. conventional tillage – on the right – on the same soil type since 1978 (Ponta Grossa, Brazil)

[T.F. Shaxson]



the same, has profound implications. The best conditions for root growth and function appear to be where there has been no disturbance by tillage implements and where soil organisms are doing the work of burrowing, transforming and aggregating soil constituents. It may also be that differences in soil moisture inferred from runoff measurements under different tillage treatments may be insufficient to explain differences in root measurements and in final yield.

A pioneer farmer in Paraná, Brazil, whose soil conditions have been monitored from 1978 to the present, has kept detailed yield records. These show that under residue-based zero tillage, yields of both maize and soybean have been rising and have become less variable from year to year (Figure 25). Annex 8 provides information on similar experiences of a large-scale farmer in Chile.

**FIGURE 25**  
Frank' Anna farm's production graphs 1978-2000 in Paraná, Brazil (after Dijkstra, 2000)

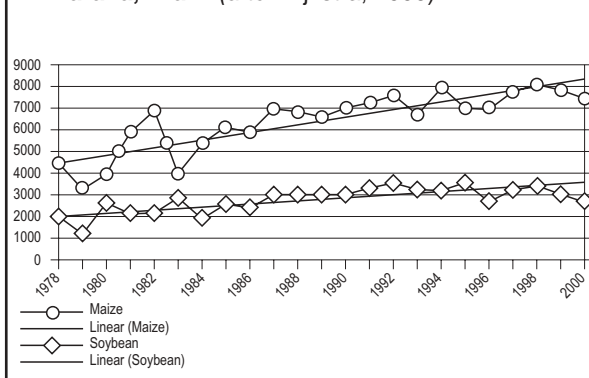

**Effects on some other soil health indicators**

The impacts of zero tillage (ZT) and conventional tillage<sup>1</sup> (CT) on soil health are shown by comparing some soil indicators for both systems:

- diameter and stability of soil aggregates (Table 15)
- soil organic matter content at 20 cm depth (Table 16)
- number of earthworms (Table 17)

Saturnino and Landers (1997) measured the number of maize roots in each 10 cm layer of soil to 1 m depth after 15 years of constant treatment (zero

**TABLE 15**

Changes in mean diameter and stability of soil aggregates after 7 years of rotation under residue-based zero tillage (ZT) and conventional tillage (CT) in Paraná, Brazil (FAO, 2001c)

Tillage system	Rotation	Aggregate stability (index)		Mean diameter of aggregate (mm)	
		0–10	10–20	0–10	10–20
Depth (cm)		0–10	10–20	0–10	10–20
ZT	Lupins-Maize-Oats-Soybean-Wheat-Soybean	41.1	37.4	1.8	1.7
CT	Wheat-Soybean-Wheat-Soybean-Wheat-Soybean	26.8	34.3	1.6	1.3

<sup>1</sup> Disc plough + harrowing.

tillage and conventional tillage). The results in Table 18 show marked differences. Zero tillage and crop rotation favour recycling of nutrients and better soil structure, resulting in better root development and higher production.

A research report from 1983 showed similar differences in root distribution of soybeans. While the total number of roots was the same to 1 m depth, they were more evenly distributed down the profile with zero tillage than with conventional tillage (Derpsch *et al.*, 1991).

### Effects on erosion and runoff

Conservation agriculture compared with conventional tillage results in markedly reduced soil erosion and runoff, as shown in results from Brazil and Paraguay. This effect is attributed to the increased soil porosity beneath residues due to biological activity. Note the saving of 441 mm water by reduction of runoff in southern Brazil and 186 mm in central Brazil (Table 19).

In the Município of Tupanssi in Paraná it was reported that, following adoption of residue-based zero tillage, the turbidity of the river water has fallen from an index of 8 000 to 80 (author's field notes). A group of farm families, whose houses were on the slopes of cultivated fields recently transformed by zero tillage, said they were pleased that the runoff water and sediment no longer rushed down the hillsides into their houses, damaging the rugs and carpets on the floors (author's field notes).

TABLE 19

Losses of soil and water under conventional tillage (CT) and residue-based zero tillage (ZT) (Saturnino and Landers, 1997)

	Soil losses (t/ha/year)			Runoff losses (mm/ha/year)		
	CT	ZT	Difference %	CT	ZT	Difference %
<b>Paraná (southern Brazil)</b>						
12 years of wheat-soybean rotation	26.4	3.3	87	666	225	66
<b>Cerrados (central Brazil)</b>						
Soybean	4.8	0.9	81	206	120	42
Maize	3–3.4	2.4	20–29	252–318	171	32–41
<b>Paraguay</b>						
4 years' maize/soybean	21.4	0.6	97	-	-	-
2 days with 186 mm rain	46.5	0.01	< 99	-	-	-

TABLE 16

Buildup of soil organic matter under ZT compared with conventional cultivation (FAO, 2001c)

System and duration	Mean organic matter* 0-20 cm depth (%)
CT	2.5
Zero tillage – 4 years	2.7
Zero tillage – 7 years	2.9
Zero tillage – 10 years	3.1

\* Discounting the crop residue mulch layer above

TABLE 17

Influence of different methods of soil preparation on population of earthworms in Paraná, Brazil (FAO, 2001c)

Soil type	No. of worms/ m <sup>2</sup> to 30 cm depth	No. of worms/ m <sup>2</sup> to 10 cm depth
	Latossolo roxo	Terra roxa estruturada
ZT	27.6	13.0
Scarification with tines	5.2	7.5
CT	3.2	5.8

TABLE 18

Number of maize roots to depth of 1 m after 15 years of zero tillage (ZT) and conventional tillage (CT) in Paraná, Brazil (after Saturnino and Landers, 1997)

Depth-layer (cm)	Under ZT for 15 years	Under CT for 15 years
00–10	142	103
10–20	80	65
20–30	72	37
30–40	74	56
40–50	84	64
50–60	83	101
60–70	79	55
70–80	61	71
80–90	45	28
90–100	16	27

**PLATE 76**  
**Improved management of the soil upslope resulted in this pond reappearing and persisting through the dry season (Toledo, Brazil)**  
*[T.F. Shaxson]*



**PLATE 77**  
**Further down the same catchment, the adoption of zero tillage crop production above showed its effect in much-extended river flow, with considerable income improvements for this small farmer (Toledo, Brazil)**  
*[T.F. Shaxson]*

If runoff and erosion are symptoms of soil misuse, the major reduction in both occurrences signifies that their causes must have been significantly reduced.

### **Effects on catchment hydrology**

An example of positive changes in catchment hydrology is provided by a representative catchment near Toledo in Paraná, Brazil. Soon after the adoption of zero tillage on rolling wheat lands, farm families observed that a pond which formerly had been dry for much of the year filled with water and hydrophytic vegetation took hold again (Plate 76). Further down the catchment, the river, which had ceased to flow in the dry season began to flow again throughout the year, so that a small farmer on its banks was able to improve his livelihood by investing in irrigation equipment and in excavating fishponds. This farmer now keeps fishponds full of water through the year and charges people to come fishing for fun at the weekends (Plate 77).

### **Effects of zero tillage systems on farm economics**

Farmers have responded to the economic benefits of zero tillage. Yield increases of 20 percent or more, coupled with reduction of production costs by a similar percentage, have had positive effects on farm income. Savings of time and labour have contributed to improvements in farm families' livelihoods.

For instance in Paraguay, on farms using conventional tillage systems, severe losses of soil, nutrients and organic matter were seen as a root cause of declining yields of a range of crops. Some farms had adopted zero tillage, others not. Farm records over 10 years were used to construct economic models and indicators of differences. On representative mechanized 135 ha farms growing rotations including oats, soybean, sunflower, maize, wheat, crotalaria,



TABLE 20

Comparative short- and long-term economic results on typical 135 ha farms with tractor power, from conventional tillage (CT) and residue-based zero tillage (ZT) in San Pedro and Itapua regions, Paraguay (FAO, 1997)

	First year		Tenth year	
	CT	ZT	CT	ZT
<b>San Pedro</b>				
Incomes and costs (US\$)				
Total farm income	77 031	75 010	68 632	93 762
Total variable costs	53 484	51 467	53 026	48 166
Total fixed costs	18 618	14 974	18 618	14 454
Net farm income	4 929	8 569	-3 013	31 142
Return on capital (%)	1.8	3.2	-1.1	13.3
Annual tractor hours	1 228	1 177	1 210	776
<b>Itapua</b>				
Total farm income	64 688	63 675	61 454	102 856
Total variable costs	38 818	36 674	41 792	56 077
Total fixed costs	18 567	17 299	18 567	13 075
Net farm income	7 304	9 771	1 095	33 703
Return on capital (%)	1.8	2.4	0.3	8.3
Annual tractor hours	1 179	981	1 179	786

TABLE 21

Summary of farming system results on small farms with cotton, soybeans, tobacco, maize (Sorrenson *et al.*, 1998)

	Farmer	Edelira				San Pedro		
		Bruno	Mendoza	Florencio	Victor	Agustin	Lucas	Oporto
		Hectares	20	9.2	18	19.5	8.5	5
<b>Conventional Cultivation</b>								
Labour	Person-day	381	181	300	379	183	164	163
Net Farm Income	US\$	567	1 960	2 844	2 905	1 416	571	1 448
Return to Labour	US\$/day	1.49	10.85	9.47	7.66	7.74	3.49	8.88
<b>Zero Tillage</b>								
Labour	Person-day	0	132	239	350	0	154	171
Net Farm Income	US\$	0	3 184	3 853	5 778	0	1 919	2 538
Return to Labour	US\$/day	0	24.15	16.14	16.52	0	12.46	14.84
Incremental Net Farm Income	US\$	0	1 224	1 008	2 873	0	1 348	1 090
Increase in Net Farm Income	%	0	62	35	99	0	236	75

vetch with zero tillage (ZT) farm incomes rose while those using conventional tillage (CT) for rotations with soybean, oats, wheat, maize fell. The returns on capital increased on farms using zero tillage, but declined on those using conventional tillage. Reduction of tractor-hours, reduced use of fuel and lower costs of repairs, etc. contributed to the economic benefits of zero tillage on these farms (Table 20).

In another study in Paraguay, the economics of zero tillage on seven smaller farms (20 ha or less) without tractors were studied. Five out of the seven farmers had both conventional and zero tillage areas on their properties (Table 21).

The small-farm study illustrates that zero tillage is not only financially attractive to small farmers but also has high economic pay-off for the nation. In Paraguay it has been estimated that for 1997 the national economic benefit due to the adoption of zero-tillage systems reached US\$941 million. These included the saving in nutrients lost from soil from erosion, plus the costs saved in reduced tractor hours, less fuel and fertilizer.



**Box 8: POTENTIAL BENEFITS TO THE APPLICATION OF RESIDUE-BASED ZERO TILLAGE SYSTEMS TO THE WHOLE AREA OF ANNUAL CROPS IN THE STATE OF PARANÁ, BRAZIL**

- **Cost of erosion:** Considering losses of soil of 10 t/ha/year on the 6 million ha and the value of the macronutrients. It is estimated that the costs of erosion are greater than US\$121 million and that gully erosion repair costs more than US\$10.3 million per year.
- **Reduction in the cost of fertilizers:** The savings by applying less phosphorus in zero tillage systems and using lupins as the source of nitrogen before maize, would represent a minimum gain of US\$29 million.
- **Elimination of the costs of replanting:** Saving costs of replanting after erosion could represent a benefit greater than US\$5.6 million.
- **Savings in herbicides:** The potential saving by planting black oats followed by soybean for weed suppression could be greater than US\$5.7 million.
- **Savings in fuel:** The estimated reduction in costs of fuel required for soil preparation was greater than US\$1.9 million in 1984.
- **Costs of physical conservation works:** The savings on constructing and maintaining terraces could reach US\$1.2 million. The value of the added production resulting from more land being available because of the reduction in the number of terraces needed, is estimated at approximately US\$3.2 million
- **Increase in production:** The value of additional production was estimated at a minimum of US\$5.7 million in 1984 on the basis of the differences in crops' productivity between direct drilling and conventional cultivation observed in the experiments at IAPAR.
- **Externalities:** Eroded soil coming from cropped areas tends to sediment rivers, roads, etc. and increase water pollution. SUREHMA estimated that the value of macronutrients which are believed to arise in Paraná from upstream of the Itaipu Dam (the country's major hydroelectric facility) is more than US\$419 million.
- **Analysis of the cost-benefit ratio of soil conservation:** Investments of US\$19 million/year would provide a return of 20 percent per year with the widespread adoption of adequate practices (particularly zero tillage and crop rotations) over a time period of 20 years.

(after Sorrenson and Montoya, 1989)

The 1980 agricultural census of Paraná State, Brazil showed that there were over 6 million ha of annual crops. A 1989 report indicated the annual benefits if residue-based zero tillage systems were to be applied to the full 6 million ha (Box 8).

### OBSERVATIONS ABOUT RESIDUE-BASED ZERO TILLAGE SYSTEMS IN LATIN AMERICA

From the full application of both the concepts and integrated techniques of residue-based zero tillage (also called Conservation Agriculture), farmers have achieved many direct and indirect benefits, often recorded together on individual farms (Instituto CEPA/SC, 1999; FAO, 2001b).

On-farm benefits included:

- marked and rapid increase of organic matter content in upper layers of soil and increased biodiversity, number and activity (of earthworms, fungi, bacteria, etc.) in the soil;
- better soil structure and stability of soil aggregates; significantly higher infiltration rates; soil loss reduced by over 80 percent, runoff by 50 percent or more; more intensive but safe use of sloping areas made possible;
- increase in nutrients stored, greater availability of P, K, Ca, Mg in the root zone; less fertilizer needed for same result;
- better germination and development of plants, better root development and to much greater depth; better resilience of crops in rainless periods due to increased water holding capacity;
- yields often higher, typically + 20 percent for maize, + 37 percent for beans, + 27 percent for soybean, + 26 percent for onions; with less year-to-year yield variation;

- reduced variations of soil temperature during the day, with positive effects on plants' absorption of water and nutrients;
- less investment and reduced use of machinery and animals in crop production; reduced costs for labour, fuel and machinery-hours perceptible within 2 years. Operational net margins per ha rose by between + 58 percent and + 164 percent, because of combination of lower cost of production and increase in yields, which provides greater resilience against falling market prices and bad weather;
- greater flexibility in farm operations especially over optimum dates for planting; increasing possibilities for diversification into livestock, high-value and different crops, vertical integration into product processing and other activities; improved quality of life.

Off-farm benefits widely noted by rural agency staff and others, included:

- flooding risks reduced by 30-60 percent due to greater rainfall infiltration and delays to overland flows. Extending the time of concentration; better recharge of underground aquifers, improving groundwater reserves and dry season flow in springs and streams;
- less herbicide use after first years; less pesticide use, more recycling of animal wastes; reduction of pollution and eutrophication of surface waters by agricultural chemicals carried in surface runoff and eroded soil; less sedimentation and infrastructure damage, e.g. silting of waterways, large dams. A conservative estimate for the Cerrado region was given as US\$33 million per year;
- reduced water treatment costs (ca. 50 percent) due to less sediment, less bacterial and chemical contamination;
- savings of up to 50 percent in costs of maintenance and erosion avoidance on rural roads;
- reductions in fuel consumption of 50-70 percent or more and proportional reduction in greenhouse gas emissions;
- reduced pressure on the agricultural frontier and reduced deforestation by high-yielding, sustainable conservation agriculture and increased pasture carrying capacity through rotation with annual crops;
- enhanced diversity and activity of soil biota;
- reduced carbon emissions through less fuel use and enhanced carbon sequestration by not destroying crop residues and increasing, rather than losing, soil organic matter (FAO, 2001a).

The zero tillage systems of Latin America thus are not only a great improvement on former tillage-based systems, but also have major off-site and national benefits, to which improvements in soil moisture management make a large contribution. The effects are illustrated by the colour of the water going over the Iguassu Falls in southern Brazil (Plates 78 and 79). By chance these two Plates were taken from the same viewpoint 7 years apart, one in the wet season when high runoff also transported much eroded soil, the other in the dry season when water that had seeped down through the soil to the groundwater provided the dry-season flow.

#### **CONSTRAINTS OF CONSERVATION AGRICULTURE AND SOME APPROACHES TO OVERCOME THEM**

Conservation agriculture has been successfully employed in subhumid as well as humid climates, but there are still some constraints in semiarid environments that may hinder its immediate application. Typical of these constraints are:

**PLATES 78 AND 79**

**River flow in two seasons before and after the improvements in the catchments wrought by widespread conservation agriculture in the form of residue-based zero tillage (Foz do Iguassu, Brazil). People who recently visited the site during the rains say that the water even in the wet season is now as clear as it is in the dry season (Benites, pers. comm.)**

*[T.F. Shaxson]*



- shortage of water limiting crop and residue production;
- insufficient residues produced by the economically or socially important crops and lack of knowledge of suitable cover crops;
- sale or preferential use of crop residues for fodder, fuel and building materials;
- inability to control livestock grazing, especially in areas where communal grazing is traditional (tenant farmers are often obliged to allow the landowner's cattle to graze the residues after harvest);
- inability to control residue consumption by termites;
- insufficient money or credit to purchase appropriate equipment and supplies;
- lack of knowledge of conservation agriculture by extension and research staff.

A number of approaches have been explored and are being tested to overcome these constraints. In situations where crop residues are preferentially used as fodder, additional new sources of fodder may be produced, provided they can be protected from grazing by, for example, live fences (León, 1994). Hay or silage may be produced as additional dry-season fodder from improved pasture species, or from forage trees or crops of high biomass grown specifically for this purpose (Barber, 1998). Forage trees can be established as live fences along farm and field boundaries, and forage grasses may be produced as live barriers, on bunds, and along field boundaries and roadways. In Bahir Dar, Ethiopia, farmers are increasing fodder production by undersowing forage legumes in other crops, establishing forage strips between arable crops, and by oversowing mixtures of legume seeds on grazing areas (Lemlem, 1998).

Certain crop sequences are less suited to direct sowing into crop residues because of the likelihood that weed, pest or disease problems will become intensified by being transmitted

from one crop to the next. Examples of less suitable crop sequences and their specific problems encountered in eastern Bolivia (Barber, 1994) are:

- wheat every year – disease problems;
- soybean every year – pest and disease problems;
- soybean-sunflower sequences – disease problems;
- maize-sorghum or sorghum-black oats – weed and pest problems;
- sunflower-cotton – the problem of volunteer sunflower weeds;
- bean-soybean sequences – pest and disease problems.

Weed problems may also be caused by volunteer germination of the previous crop; for example, sunflower volunteers can be particularly difficult to eradicate. To avoid such problems, appropriate crop rotations, acceptable to the farmers, must be selected.

In environments where there are many constraints to the introduction of conservation agriculture, a pragmatic, phased approach may be the most feasible, in which individual constraints are progressively overcome until an appropriate system of conservation agriculture can be fully implemented. This may require the planned introduction of measures such as improved grass species and fodder trees, hay and silage production, live fences, stall-fed livestock, improved crop rotations with cover crops, formation of farmers' associations, credit supply and local or international training visits for farmers, extension and research staff (FAO, 2001b).

The introduction of conservation agriculture is unlikely to be immediately successful on seriously degraded soils with surface crusts, compacted layers, low fertility or severe weed infestations unless these problems are first overcome by appropriate remedial actions. Hardsetting soils may not be immediately suitable for conservation agriculture because of the difficulties of overcoming soil compaction problems and maintaining good soil porosity within the topsoil and subsoil. Consequently crop rooting is frequently restricted to shallow depths. In this case, deep tillage followed by the establishment of cover crops prior to introducing conservation agriculture, and then the adoption of crop rotations that produce large quantities of residues, will progressively improve the physical condition of these soils and make conservation agriculture possible.

Conservation agriculture is less likely to be successful in poorly drained soils because the added residues will intensify anaerobic conditions, in which toxic substances harmful to crop growth may be produced.

The cost of no-till planters and seed drills needed for direct sowing may be a major constraint for mechanized farmers, unless it is possible to modify their existing seed drills and planters. For small farmers, hand tools and animal-drawn equipment exist and local blacksmiths can often adapt them, provided they have access to information and samples.

## References

- Abay, F., Haile, M. & Waters-Bayer, A.** 1998. Farmers' innovations in land and water management. *In LEISA (ILEIA Newsletter for low external input and sustainable agriculture)*. 14 (1): 21-23.
- Barber, R.G.** 1994. *Rotaciones de cultivos para zonas con 1000 a 1300 mm de lluvia por año en el departamento de Santa Cruz, Bolivia*. CIAT, Santa Cruz.
- Barber, R.G.** 1995. Soil degradation in the tropical lowlands of Santa Cruz, eastern Bolivia. *In Land degradation and Rehabilitation*, 6: 95-107.
- Barber, R.G.** 1998. Linking the production and use of dry-season fodder to improved soil conservation practices in El Salvador. *In Towards sustainable land use: furthering co-operation between people and institutions*. (eds.: H.P. Blume, H. Eger, E. Fleischhauer, A. Hebel, C. Reij & K.G. Steiner). Vol. II. *Advances in Geoecology* 31: 1311-1317. Reiskirchen: Catena-Verlag. ISBN 3-923381-42-5.
- Barber, R.G. & Diaz, O.** 1992. Effects of deep tillage and fertilization on soybean yields in a compacted Ustochrept during seven cropping seasons, Santa Cruz, Bolivia. *In Soil and Tillage Research* 22: 371-381.
- Barber, R.G. y Johnson, J.** 1993. Aspectos técnicos sobre la instalación de cortinas rompevientos para la producción de cultivos anuales. *Informe técnico No. 2*. Santa Cruz, Bolivia. Centro de Investigación Agrícola Tropical y Misión Británica en Agricultura Tropical. 20 pp.
- Barber, R.G. & Thomas, D.B.** 1981. Infiltration, surface runoff and soil loss from high intensity simulated rainfall in Kenya. FAO Research Contract No. RP/HQ 1977-3/AGL. Faculty of Agriculture, University of Nairobi, Kenya.
- Barry, D. y Rosa, H.** 1995. Crisis de la economía rural y medio ambiente en El Salvador. En *PRISMA, (Programa Salvadoreño de investigación sobre desarrollo y medio ambiente)*, Vol. 9, Enero-Febrero 1995. San Salvador, El Salvador.
- Batchelor, C., Rama Mohan Rao, M. & Mukherjee, K.** 2000. Watershed development – or should it be watershed management?. *Case Study 12 of FAO E-Workshop: Land-Water Linkages in Rural Watersheds*, 18 Sept- 27 Oct. 2000. (Available at <http://www.fao.org/ag/agl/watershed/>).
- Baxter, J.** 1995. Farmers who fallow with trees. *In Agroforestry Today*, 7 (3-4): 8-10.
- Bell, M., Faulkner, R., Hotchkiss, P., Lambert, R., Roberts, N. & Windram, A.** 1987. The use of dambos in rural development with reference to Zimbabwe. Final report of the ODA Project. Loughborough, UK. Loughborough University and Harare: University of Zimbabwe.
- Brady, N.C.** 1974. *The Nature and properties of soils*. 8<sup>th</sup> Edition. Macmillan, New York.
- Briggs, S.R., Ellis-Jones, J., Miiro, H.D. & Tumuhairwe, J.** 1998. Soil and water conservation in the farming systems of Kamwezi, Southwest Uganda. *In* (eds.: S.R. Briggs, J. Ellis-Jones and S.J. Twomlow) *Modern methods from traditional soil and water conservation technologies*. Proceedings of a DFID land management workshop, Kabale, Uganda, 13-15 January, 1998. International Development Group Report No. IDG/98/10. Silsoe Research Institute. ISBN 0-9531282-0-3. pp. 84-97.
- Bunch, R.** 1995. *Two ears of corn; a guide to people-centred agricultural improvement*. Oklahoma City, Oklahoma, USA. World Neighbours. 251 pp.
- Carver, A.J.** 1981. *Fotografia aérea para planejadores de uso da terra* (Portuguese version, 1988). Brasília: Ministerio da Agricultura /Secretaria de Recursos Naturais. 77 pp.



- Christiansson, C.** 1988. Degradation and rehabilitation of agropastoral land – perspectives in environmental change in semiarid Tanzania. *In Ambio*. 17 (2): 144-152.
- Clegg, M.D.** 1996. Crop management: nutrients, weeds and rain. *In Proc. Int. Pearl Millet Workshop*, April, 1986. India, ICRISAT. pp. 91-97.
- Derpsch, R., Roth, C.H., Sidiras, N. & Kopke, U.** 1991. *Controle da erosao no Paraná, Brasil: sistemas de cobertura do solo, plantio direto e preparo conservacionista do Solo*. Eschborn, Germany, GTZ. ISBN 3-88085-433-5. pp. 76; 101; 112,113. 268 pp.
- Dijkstra, F.** 2000. Harmony between man and field. Notes for lecture. FAO, Rome.
- Douglas, M.** 1994. Sustainable use of agricultural soils – a review of the pre-requisites for success or failure. *In Development and Environment Report No. 11*. Berne, Switz.: Univ. Berne, Inst. Geography.
- Douglas, M.G., Mughogho, A.R., Saka, A.R., Shaxson, T.F. & Evers, G.** 1999. Malawi: An investigation into the presence of a cultivation hoe-pan under smallholder farming conditions. *TCI Occasional Paper Series No. 10*, November 1999. Investment Centre Division, FAO, Rome.
- Dowker, B.D.** 1964. A note on the reduction in yield of Taboran maize by late planting. *In East African Agricultural and Forestry Journal* 30: 32-33.
- Elkins, C.B.** 1985. Plant roots as tillage tools. *In Soil Dynamics (International conference on soil dynamics, Auburn, University, 1985)*. Office of continuing education, Auburn University, AL. pp. 519-523.
- Elkins, C.B., Haaland, R.L. & Hoveland, C.S.** 1977. Grass roots as a tool for penetrating soil hardpans and increasing crop yields. *In Proceedings 34<sup>th</sup> southern pasture and forage improvement conference*, Auburn, AL. pp. 21-26.
- FAO.**1991. Water harvesting – a manual for the design and construction of water harvesting schemes for plant production. *AGL Miscellaneous Papers 17*. FAO, Rome.
- FAO.**1995a. Sustainable dryland cropping in relation to soil productivity. By Pearson, C.J., Norman, D.W. and Dixon, J. *In FAO Soils Bulletin No 72*. FAO, Rome. ISBN 92-5-103792-2. 146 pp.
- FAO.** 1995b. Agricultural investment to promote improved capture and use of rainfall in dryland farming. *Investment Centre Technical Paper 10: 4*. ISBN 92-5-103630-6. FAO, Rome.
- FAO.** 1995c. Tillage systems in the tropics; management options and sustainability implications. By Lal, R. *In FAO Soils Bulletin No 71*. FAO, Rome. ISBN 92-5-103776-0. 206 pp.
- FAO.** 1996a. Land husbandry - Components and strategy. By E. Roose. *In FAO Soils Bulletin No 70*. FAO, Rome. ISBN 95-5-203451-6.
- FAO.** 1996b. World Food Summit. Volume 3 – *Technical background documents 12-15 (15-Technical Atlas, map 12)*. FAO, Rome.
- FAO.** 1997. Paraguay - Financial and economic implications of no-tillage and crop rotations compared to conventional cropping systems. *TCI Occasional Paper Series No. 9*. Investment Centre Division, FAO, Rome. 13 pp.
- FAO.** 1999a. New concepts and approaches to land management in the tropics with emphasis on steplands. *In FAO Soils Bulletin No. 75*. ISBN 92-5-104319-1. FAO, Rome. 125 pp.
- FAO.** 1999b. Uganda: soil fertility initiative, *Concept Paper. Report No. 99/024 CP-UGA*. National Agricultural Research Organization (NARO), Ministry of Agriculture, Animal Industry and Fisheries, Uganda, and Investment Centre Division, FAO/World Bank Cooperative Programme. FAO, Rome.
- FAO.** 2000a. Agriculture: towards 2015/30. *Technical interim report*. Economic and Social Dept., FAO, Rome.

- FAO.** 2000b. Guidelines and reference materials on integrated soil and nutrient management and conservation for farmers' field schools. *Report AGL/MISC/27/2000*. FAO, Rome.
- FAO.** 2000c. Soil conservation and management for small farms – experiences from the State of Santa Catarina, Brazil. *In FAO Soils Bulletin No. 77*. 66 pp. FAO, Rome.
- FAO.** 2000d. Manual on integrated soil management and conservation practices. *In FAO Land and Water Bulletin No. 8*. FAO, Rome. ISBN 92-5-104417-1. 214 pp.
- FAO.** 2001a. Conservation agriculture – Case studies in Latin America and Africa. *In FAO Soils Bulletin No. 78*. FAO, Rome. ISBN 92-5-104625-5. 69 pp.
- FAO.** 2001b. *FAO/World Bank global farming systems study: challenges and priorities to 2030 – Synthesis and global overview*. FAO, Rome. p. 83.
- FAO.** 2001c. No-till agriculture for sustainable land management: lessons learned from the 2000 Brazil study tour. *Draft for TCI Occasional Paper Series*. Rome: FAO Investment Centre Division.
- FAO.** 2002. *Soil moisture and food security in tropical and subtropical agriculture*. To be published. FAO, Rome.
- FEBRAPDP.** 2000. *Expansão da área cultivada em plantio direto*. Ponta Grossa, Brazil: Federação brasileira de plantio direto na palha.
- Fordham, R.** 1969. Some physiological responses of tea (*Camellia sinensis*) to moisture stress and irrigation. *In Tea Research Foundation of Central Africa, 1969. Annual Report 1968/69*. Mulanje, Malawi: TRFCA. pp. 76-77.
- Gregory, P.J., Simmonds, L.P. & Warren, G.P.** 1997. Interactions between plant nutrients, water and carbon dioxide as factors limiting crop yields. *In Phil. Trans. R. Soc. Lond. B*. 352, 987-996.
- Hamblin, A.P.** 1985. The influence of soil structure on water movement, crop root growth and water uptake. *Advances in agronomy*. 38:95–158
- Hamilton, L.S.** 1986. Towards clarifying the appropriate mandate in forestry for watershed rehabilitation and management. *In Strategies, approaches and systems in integrated watershed management. Proceedings. FAO Conservation Guide No 14*. FAO, Rome, 1986.
- Hamilton, P.** 1997. Goodbye to hunger! Effects of composted double-dug beds on small farmers' livelihoods in Kenya. Conservation farming with near-nil investment. *Summary of Report 12/97*. Nairobi: Association for Better Land Husbandry (ABLH).
- Hassane, A., Martin, P. & Reij, C.** 2000. *Water harvesting, land rehabilitation and household food security in Niger: IFAD's soil and water conservation project in Illéla District*. The International Fund for Agricultural Development (IFAD) and The Programme on Indigenous Soil and Water Conservation in Africa, Phase II (ISWC II), Vrije Universiteit, Amsterdam. 49 pp.
- Hellin, J., Haigh, M. & Marks, F.** 1999. Rainfall characteristics of hurricane Mitch. *In Nature*, 399: 316. 27 May 1999.
- Hudson, N.W.** 1995 (2<sup>nd</sup> edn.) *Soil conservation*. London: Batsford. ISBN 0-7134-7353-3. 391 pp.
- ICRAF,** 1997. *Using the wild sunflower, Tithonia, in Kenya for soil fertility and crop yield improvement*. Nairobi, Kenya. International Centre for Research in Agroforestry.
- Instituto CEPA/SC.** 1999. Avaliação do projeto Microbacias. Relatório Final. Florianópolis, Brazil: CEPA/SC. 40 pp.
- Johnson, J. y Tarima, J.M.** 1995. *Selección de especies para uso en cortinas rompevientos en Santa Cruz, Bolivia*. Centro de Investigación Agrícola Tropical y Misión Británica en Agricultura Tropical. Santa Cruz, Bolivia. 83 pp.
- Jonsson, L., Singisha, M.A. & Mbise, S.M.E.** 1999. *Dry land farming in LAMP/SCAPA; Why dry land farming?* Paper presented at the Conservation Tillage Workshop organised by RELMA, Machakos, 23-26 November 1988.

- Kandel, D.D. & Wagley, M.P.** 1999. Some salient indigenous technology practices for watershed management in Nepal. *PWMTA Field Document No. 16*. Asian WATMANET, Participatory Watershed Management Training in Asia (PWMTA) Program, GCP/RAS/161/NET, FAO(UN), Kathmandu, Nepal.
- Karabayev, M., Satyabaldin, A., Benites, J., Friedrich, T., Pala, M. & Payne, T.** 2000. *Conservation tillage: A viable option for sustainable agriculture in Eurasia*. Almaty, Kazakhstan, CIMMYT; Aleppo, Syria, ICARDA. ISBN 970-648-048-X.
- Krantz, B.A. & Kampen, J.** 1978. Soil and water management in the semi-arid tropics. *In Soil Resource Data for Agricultural Development*. Honolulu, Hawaii Agri. Expt. Stn. p. 232.
- Lal, R.** 1976. Soil erosion problems on an Alfisol in western Nigeria and their control. *In IITA Monograph No. 1*. Ibadan, Nigeria.
- Lal, R.** 1994. Sustainable land use systems and soil resilience. *In Soil resilience and sustainable land use*. CAB International, Wellingfor, UK. ISBN 0-85198-871-7. p.54.
- Lal, R., De Vleeschauwer, D. & Mlafa Nganje, R.** 1980. Changes in properties of a newly cleared tropical Alfisol as affected by mulching. *In Soil Sci. Soc. Am. J.* 44: 827-833.
- Landers, J.N.** 1998. Zero tillage development in tropical Brazil. *In Conservation Tillage for Sustainable Agriculture. Proc. International Workshop*, Harare, Zimbabwe June 1998 (eds.: J.R. Benites, E. Chuma, R. Fowler, J. Kienzle, K. Molapong, J. Manu, I. Nyagumbo, K. Steiner, R. van Veenhuisen) Part II (Annexes). Eschborn, Germany: GTZ.
- Landers, J.N.** 2000. *Case study: zero tillage development; in tropical Brazil – the story of a successful NGO activity*. FAO. Rome. Wageningen, Netherlands: Agricultural University. 37p.
- Lemlem, A.** 1998. Improved forages benefits ethiopian farmers. *In LEISA (ILEIA Newsletter for low external input and sustainable agriculture)*. 14: (1). 30-31.
- León, J.** 1994. *Sistemas agroforestales para el departamento de Santa Cruz: cercos con postes vivos*. CIAT y Banco mundial, Santa Cruz, Bolivia.
- Lesotho Government.** 1987. *Lesotho statistical yearbook, 1987*. Maseru: Bureau of Statistics.
- Letayo, E. A., Saadan, H. M., Mndolwa, S. I., Gupta, S. C. & Monyo, E. S.** 1996. Evaluation of crop performance and farmer preferences for pearl millet varieties in Tanzania. *In Drought-tolerant crops for southern Africa: Proceedings of the SADC/ICRISAT Regional Sorghum and Pearl millet Workshop, 25-29 July, 1994*, Gaborone, Botswana (eds.: K. Leuschner and C.S Manthe). Patancheru 502324, Andhra Pradesh, India: International Crops Research Institute for the Semi-arid Tropics. pp. 65-70.
- Liniger, H.P.** 1990. Water conservation for rainfed farming in the semi-arid foothills west and north-west of Mount Kenya: consequences for soil productivity. *In* (eds.: B. Messerli, H. Hurni) *African Mountains and Highlands – Problems and Perspectives*. Walsworth Press Co., Marceline, Missouri . pp. 187-203 . in English. Code: PA39 . CHF 5.00.
- Lopez, G. & Bunch, R.** 2000. Farmers developing technology: the researcher's role revised. *In LEISA (ILEIA Newsletter for low external input and sustainable agriculture)*. 16 (1): 22-23.
- Lovelock, J.** 1991. *Gaia: the practical science of planetary medicine*. London: Gaia Books. ISBN 1-85675-040-X.
- Lugo-Lopez, M.A.** 1960. Pore size and bulk densities as mechanical soil factors impeding root development. *In Journal of the Agricultural University of Puerto Rico* 44: 40-44.
- LWMP.** 1992. Main Final Report. *Crop production, rainfall, runoff and availability of soil moisture in semi-arid Botswana*. (eds.: D. Harris, G. Fry, S.T. Miller and A. Pain). Sebele, Botswana, SACCAR/NRI.
- Malawi Government.** 1957-85. *Annual reports*. Zomba: Dept. of Agriculture.

- Maurya, P.R. & Lal, R.** 1979. Effects of bulk density and soil moisture on radicle elongation of some tropical crops. In (eds.: R. Lal and D.J. Greenland) *Soil physical properties and crop production in the tropics*. Wiley, Chichester, UK. pp. 339-347.
- McCall, W.W. & Gitlin, H.M.** 1973. Constructed windbreaks for Hawaii. *Circular 473*. Honolulu, Hawaii, Cooperative Extension Service, University of Hawaii. 16 pp.
- McCall, W.W., Shigeura, G.T. & Tamimi, Y.N.** 1977. Windbreaks for Hawaii. *Circular 438*. Honolulu, Hawaii, Cooperative Extension Service, University of Hawaii.
- Meek, B.D., Rechel, E.R., Carter, L.M. & DeTar, W.R.** 1992. Infiltration rate of a sandy loam soil. Effects of traffic, tillage and plant roots. In *Soil Science Society of America Journal* 56: 908-913.
- Moore, T.R., Thomas, D.B. & Barber, R.G.** 1979. The influence of grass cover on runoff and soil erosion from soils in the Machakos area, Kenya. In *Trop. Agric. (Trinidad)* 56 (4): 339-344.
- Morse, K.** 1996. *A review of soil and water management research in semi-arid areas of southern and eastern Africa*. Chatham, UK. Natural Resources Institute.
- Moyo, A. & Haggmann, J.** 1994. Growth effective rainfall in maize production under different tillage systems in semi-arid condition and shallow granitic sand of Southern Zimbabwe. *Project research report, 10. Conservation tillage for sustainable crop production systems*. [Poster at the Thirteenth ISTRO Conference, 24-29 July 1994, Aalborg, Denmark.].
- Njihia, C. M.** 1975. Effect of tied ridges, stover mulch and farm yard manure on moisture conservation in a medium potential area of Katumani - long rains 1975. In *Annual Report*, National Agricultural Laboratories, Soils and Agricultural Chemistry Section. KARI, Kenya.
- Nyamudeza, P. & Maringa, D.** 1993. Effects of bare fallow and previous crop on residual soil water and yields of sorghum, maize and cotton in south east lowveld in Zimbabwe. In *Proceedings of the third annual scientific conference of the SADC – Land and Water Management Research Programme, 8-10 October, 1992*. Harare, Zimbabwe.
- Ouedraogo, M. & Kaboré, V.** 1996. The zai: a traditional technique for the rehabilitation of degraded land in the Yatenga, Burkina Faso. In *Sustaining the soil – indigenous soil and water conservation in Africa*. (eds.: C. Reij, I. Scoones, C. Toulmin) 1996. London: Earthscan Publications. ISBN 1-85383-372-X. pp. 80-84.
- Ouedraogo, A. & Sawadogo, H.** 2000. Three models of extension by farmer innovators in Burkina Faso. In *LEISA (ILEIA Newsletter for low external input and sustainable agriculture)* 16 (2): 21-22. July 2000.
- Pacey, A. & Cullis, A.** 1986. *Rainwater harvesting – the collection of rainfall and runoff in rural areas*. IT Publications, London.
- Poole, D.A.** 1971. Involvement or commitment?. In *J. Soil & Water Cons. (USA)* Mar/Apl. 1971: 42.
- PRISMA.** 1995. *El Salvador: Dinámica de la degradación ambiental*. San Salvador, El Salvador. Programa Salvadoreño de investigación sobre desarrollo y medio ambiente.
- Regional soil conservation unit (RSCU/Sida) and UNDP/Africa 2000 Network/Uganda.** 1997. Sustainable Agriculture Practices and Technologies; *Guidelines for Farmers*. Africa 2000 Network/Uganda, UNDP.
- Rockstrom, J.** 1999. A people without water is a people without a home. In *Stockholm Water Front; a forum for global water issues* (3): 12-13, September 1999.
- Russell, E.W.** 1961. *Soil conditions and plant growth*, 9<sup>th</sup> edition. London: Longmans Green. p. 448.
- Russell, E.W.** 1973. *Soil conditions and plant growth*, 10<sup>th</sup> edition. Longman.
- Russell, E.W.** 1988. *Russell's soil conditions and plant growth*. 11<sup>th</sup> edition. Ed. A. Wild. Longman Group, UK. ISBN 0-582-44677-5. p. 357. 991 pp.

- Saturnino, H.M. & Landers, J.N.** 1997. *O meio ambiente e o plantio direto*. Goiania, Brazil: Associacao do Plantio Direto no Cerrado.
- Shaxson, T.F.** 1993. Conservation-effectiveness of farmers' actions: a criterion of good land husbandry. *In Topics in Applied Resource Management. Vol. 3: Acceptance of Soil and Water Conservation. Strategies and Technologies.* (eds.: E. Baum, P. Wolff & M.A. Zobisch). Witzhausen, Germany. DITSL. 103-127. ISBN 3-9801686-4-6.
- Shaxson, T.F.** 1997a. Soil erosion and land husbandry. *In Land Husbandry – International Journal of Soil and Water Conservation.* 2 (1): 7.
- Shaxson, T.F.** 2001. Soil moisture conservation. *In Vol. 1 of: Conservation Agriculture, a worldwide challenge.* (eds.: L. García-Torres, J. Benites, A. Martinez-Vilela). Córdoba (Spain): XUL Publishers. 2 vols. ISBN 84-932237-1-9 (vol. 1), 84-932237-2-7 (vol.2).
- Shaxson, T.F., Hunter, N.D., Jackson, T.R. & Alder, J.R.** 1977. (metricated 1998) *A land husbandry manual: techniques of land use planning and physical conservation*. Lilongwe, Malawi, Land Resources Conservation Department, Ministry of Agriculture. 627 pp.
- Shaxson, T.F., Sweetman, L.T., Long, P.B.R. & Hudson, N.W.** 1980. *The Indo--UK Dryland Farming Operational Research Project – a Five-Year Report 1975-1979*. Vol. 1 of 2 vols. London: UK/ODA (unpublished). p. 28.
- Shepherd, K.D., Cooper, P.J.M., Allan, A.Y., Drennan, D.S.H. & Keatinge, J.D.H.** 1987. Growth, water use and yield of barley in Mediterranean-type environments. *In J. Agric. Sci., Camb.* 108: 365-378.
- Shepherd, T.G.** 1992. Sustainable soil crop management and its economic implications for grain growers. *In Proc. International Conference on Sustainable Land Management. 17-23 Nov., 1991.* Napier, Hawkes Bay, NZ. pp. 141-152. (ed. P.R Henriques). ISBN 0-473-01548-X.
- Shigeura, G.T. & McCall, W.W.** 1979. Trees and shrubs for windbreaks in Hawaii. *Circular 447.* Honolulu, Hawaii, Cooperative Extension Service, University of Hawaii. 56 pp.
- Skidmore, E.L. & Hagen, L.J.** 1977. Reducing wind erosion with barriers. *In Trans. Am. Soc. Agric. Engrs.* 20: 911-919.
- Smith, G.D. & Ruhe, R.V.** 1955. How water shaped the face of the land. *In The Yearbook of Agriculture,* 1955. Washington DC: US Dept. of Agriculture. p. 120.
- Sorrenson, W.J. & Montoya, L.J.** 1989. Implicacoes economicas da erosao do solo e do uso de algumas praticas conservacionistas no Paraná. *Boletim Tecnico no. 21.* Londrina, (Brazil): Instituto Agronomico do Paraná (IAPAR). ISSN 0100 3054.
- Sorrenson, W.J., Duarte, C. & Lopez Portillo, J.** 1998. Economics of no-till compared to traditional cultivation on small farms in Paraguay. Asunción: MAG/GTZ Soil Conservation Project. p. XV
- Sorrenson, W.J., Duarte, C. y Lopez Portillo, J.** 2001. Aspectos económicos del sistema de siembra directa en pequeñas fincas. Implicaciones en la política y la inversión. Proyecto Conservación de Suelos MAG-GTZ, San Lorenzo, Paraguay: DIA/DEAG. 84 pp.
- Speijer, P.R., Mudioppe, J., Ssango, F. & Adiapala, E.** 1998. Nematode damage and densities at different growth stages of east African highland banana (*Musa AAA*) cv. Mbwarzirume. African Plant Protection. (In Press).
- Spencer & Sivakumar.** 1986. Pearl millet in African agriculture. *In Proc. of Int. Pearl Millet Workshop, April, 1986.* India, ICRISAT. pp. 19-31.
- Squire, G.R.** 1990. *The physiology of tropical crop production.* Wallingford, UK. C.A.B. International.
- Stark, M.** 2000. Soil management strategies to sustain continuous crop production between vegetative contour strips on humid tropical hillsides. *In World Association of Soil and Water Conservation Newsletter.* 16 (4), October 2000.



- Stewart, B.A.** 1985. Water conservation technology in rainfed and dryland agriculture. *In Proceedings of Conference 'Water and Water Policy in World Food Supplies'*. Texas, USA. College Station, Texas A&M University. pp. 335-359.
- Stewart, J.I.** 1988. *Response farming in rainfed agriculture*. WHARF (World Hunger Alleviation through Response Farming) Foundation Press, Davis, USA. ISBN 0-9620274-0-5. 101 pp.
- SUA.** 1993. Evaluation and promotion of rainwater harvesting in semi-arid areas of Tanzania. Research report. *First interim technical report*. Tanzania: Sokoine University of Agriculture. (Report prepared for IDRC, Canada).
- TAJAS.** 1999. Special issue on rainwater harvesting for crop production in semi-arid Tanzania. *In Tanzania J. Agric. Sc.* 2 (2). ISSN 0856-664X. 113 pp.
- TRIEA.** 1973. *Annual report*. Kericho: Tea Research Institute of East Africa. pp. 40-41.
- Thomas, D.B. (ed.)** 1997. Soil and water conservation manual for Kenya. Nairobi, Kenya. Soil and Water conservation Branch, Ministry of Agriculture, Livestock Development and Marketing.
- Vieira, M.J., Ochoa, L.B., Fischler, M., Marin, X. y Sauer, E.** 1999. *Manual del capacitador: manejo integrado de la fertilidad del suelo en zonas de ladera*. San Salvador, MAG/CENTA, FAO. 136 pp.
- Village notes.** 2000. Soaking seed. Feedback for the Doon Valley Integrated Watershed Management Project, Dehradun, India. W.S. Atkins Technical Assistance Team & UPDesco. Volume 4, No. 2, September, 2000.
- Virmani, S.M.** 1980. Climatic approach. *In Proc. Int. Symp. On Devel. And Transfer of Technology for Rainfed Agriculture and the SAT Farmer*, 28 Aug. – 1 Sep. 1979. Patancheru, India, ICRISAT. pp. 93-102.
- Ward, R.C.** 1975. *Principles of hydrology*, 2<sup>nd</sup> Edition. McGraw-Hill, UK. p. 4, Fig. 1.1.
- Wedum, J., Doumbia, Y., Sanogo, B., Dicko, G. & Cissé, O.** 1996. Rehabilitating degraded land – zaï in the Djénne Circle of Mali. *In Sustaining the soil – indigenous soil and water conservation in Africa*. (eds.: C. Reij, I. Scoones, C. Toulmin) 1996. London: Earthscan Publications. ISBN 1-85383-372-X. pp. 62-68.
- Western Australian No-Tillage Farmers Association.** 2001. No-till fights the WA drought!. *In WANTFA Newsletter*. 9 (3): 425-426. ISSN 1329-7600.
- World Bank.** 2000. *Report no. 20482*. Implementation Completion Report (CPL-31600; SCPD-3160S) on a loan in the amount of US\$ million 33.0 to the Federative Republic of Brazil for Land Management II – Santa Catarina Project (Loan 3160-BR) June 7<sup>th</sup>, 2000. Washington DC: World Bank. pp. 36.
- Zougmore, R., Guillobez, S., Kambou, N.F. & Son, G.** 2000. Runoff and sorghum performance as affected by the spacing of stone lines in the semi-arid Sahelian zone. *In Soil and Tillage Research* 56 (3-4): 175-183.

This publication discusses the processes above, within and below the soil that enable water to move and crops to grow, and is intended to help land users make better use and take better care of these basic resources. The document will contribute to raising awareness of possibilities for better use of rainwater and improved management of soils. It will be useful to anyone concerned with maintaining and improving the productivity, quality and health of land, including farmers, advisory staff, trainers and their students, as well as technical decision-makers in governmental and non-governmental agencies. It should also encourage multidisciplinary approaches and dialogue among stakeholders of different backgrounds.

ISBN 92-5-104944-0 ISSN 0253-2050



9 789251 049440

TC/M/Y4690E/1/6.03/1100