

## **FAO's approach to support national forest assessments for Country Capacity Building**

M. Saket, D. Altrell, A. Branthomme & P. Vuorinen

FAO Forestry Department

### **1. Introduction**

The Food and Agriculture Organisation (FAO), has been reporting on forest resources for the last half a century. All countries in all regions are systematically covered. As demand of information is continually increasing, the forest resources assessment (FRA) has to widen the thematic coverage, improve data production and compilation methodologies. Countries are key players in the entire process of data production. Together with the international processes and forums, they provide FAO with the necessary orientations global forest resources assessments. The last global assessment (FRA 2000) was the most comprehensive in terms of volume of information collected and processed and the number of parameters analysed. FRA 2000 concluded however, that the level of availability and reliability of information is still low in the developing countries.

### **2. Rationale**

FAO's periodic global assessment of the forests was designed to monitor changes and trends of different parameters of the resources. Processes within the forests – degradation and/or improvement- and between forests and other land use classes through afforestation, deforestation and reforestation are important parameters to monitor through successive assessments. With the implementation of the Kyoto protocol on climate change, accurate estimates of carbon stores in the forests and trees outside forest at the national level is becoming increasingly important. Monitoring of criteria and indicators of sustainable forest management, biodiversity, etc is becoming at the centre of interest of policy makers and managers of resources at all levels.

The role of forests and trees outside forest in food security is valuable and need to be properly assessed by the national forest inventories and global forest assessments. Forests and trees provide food, shelter, employment and other wood and non wood goods and a wide range of services that are vital to people in the rural areas to sustain their livelihood. National inventories should thus address these issues and assess such a role. It should also establish the role of man and woman in resources management and use.

It is not difficult to find arguments for standardised collection of forest and forestry information that can be used for international analyses or comparisons (eg Lanly 1996, Lund 1996). The argument from the United Nations Conference on Environment and Development (UNCED) 1992 is often called upon. The United Nations conventions on biological diversity, climate change and desertification are other milestones. On a more general level, international

economic analyses and forecasting require reliable input concerning the forestry sector. The implementation of these international processes require monitoring of the forest (and other) ecosystems including the production of goods and services, as well as the legal and political frameworks for the management of land and natural resources.

Public consumption of environmental information is on the increase as the sophisticated communication technologies help the access to information through different media.

The international assessments of forests and forestry have developed from a timber oriented mode some decades ago, to include broad environmental factors, as well as socio-economic aspects. The imaginary land use boundary between forests and agricultural land has become vague as trees are increasingly grown outside the forests, and the values of non-wood forest products are being accounted for. Several environmental parameters, such as carbon cycling and biodiversity, are not confined within the land use classifications. It is thus clear that international assessments of forests and forestry should increasingly be cross-sectoral and include interactions with agriculture and remote benefits from the forest.

The FRA support to national forest inventories aims at helping countries in developing or strengthening their capacities for continued national inventories. It also aims at broadening the knowledge base of the countries on forests and tree resources at the national level based on reliable field data collected at a moderate cost on a wide range of biophysical and on management and uses parameters. The inventory approach is designed as a compromise between the volume of data needed, the precision of results and the cost of the survey. Moderate investment in data collection is expected to stimulate and encourage recipient countries and donors alike to invest in forest resources monitoring through continuous inventories.

The approach is founded on collaborative partnership between concerned governments and donors with FAO facilitating the cooperation. The Committee on Forestry in its fifteenth session in March 2001 was informed on the approach and supported, in principle the idea, recognizing its potential to improve the availability and quality of national level data and information and as useful complement to FAO's periodic global forest resources assessments.

### **3. Objectives**

The long-term objectives of the approach will be to contribute to the sustainable management of forests and TOF by providing decision makers and stakeholders with the best possible, most relevant and cost-effective information for their purpose at local, national and international levels. It aims also at assisting the countries in developing baseline information from a statistically verifiable data on the state of the forestry resources, their uses and management.

Specifically, FAO's support to national forest assessments aims at:

- Generating a set of information on a wide range of forest and tree parameters on the basis of a harmonised set of variables and a vegetation classification system and standard forest and tree survey sampling design for continuous monitoring.

- Assessing the state of the resources, the ways they are managed and used and their contribution to food security and poverty alleviation.
- Assisting the countries in building up their national capacities to design, plan and implement national forest inventories and to manage the generated information.
- Promoting multilateral co-operation and international partnerships for global forest and tree resources monitoring

## **4. Inventory methodology**

### **4.1 Forest and tree survey sampling design:**

Forest inventory refers commonly to measurements of several important parameters of forests and trees and to the analysis of abundance and distribution of individuals. The inventory in forestry is, in most cases, based on sampling. Different options of sampling design exist to survey a given forest area in a country. Each option is chosen to fit given characteristics of the surveyed population and to satisfy specific needs of information on some selected parameters for a given budget. Random sampling is commonly used. It may be simple random sampling with or without stratification. It may also be double or multistage sampling, double or multiphase sampling, etc. Systematic sampling may also be unrestricted or stratified.

An inventory may be based on temporary or permanent sample plots depending on the objectives of the survey. Monitoring of resources relies often on permanent sample plots. In order to improve precision of results temporary plots may be added to existing permanent plots in successive surveys.

For a number of motives including practicality, data quality, cost implications, the **systematic sampling** was chosen for forest and tree data collection. The systematic sampling in forest inventory is: (i) easily planned, (ii) faster in execution and mostly cheaper; (iii) it gives better estimates of the mean than unrestricted random sampling and even stratified random sampling in large areas, because the variation which may be considerable in such areas is better represented in the sample for which the distribution of the sample plots within the surveyed population is homogeneous; (iv) it gives thus better precision compared to random sampling. Ir P.J.D Versteegh, (1976); Lee White and Ann Edwards, (2000);

The selection of the sample site (or tract<sup>1</sup>) population has been done on the basis of the latitude/longitude grid. Tract location is chosen in the intersections of degrees. If a higher number of tracts is required in a country, additional tracts may be selected every half degree or even every quarter degree. The density of tracts may be higher on one axis than on the other. The density of tracts may vary also according to the defined strata. For the purpose of standardising the approach, the south-west corner of the tract is taken to correspond to the intersection of the lat/long lines.

---

<sup>1</sup> The sample site of 1 km<sup>2</sup> area where a cluster of 4 sample plots are located is called “Tract”.

Figure 1: Illustration of systematic distribution of sample sites in the country

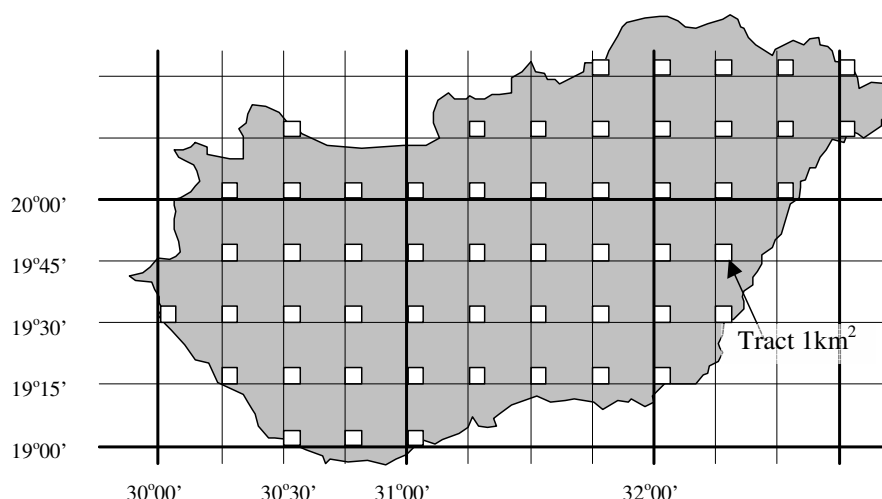

The sampling design is built up around the following principles:

- i) Stratification based on forest types and land use classes is discarded as strata may change over time and render stratified sampling irrelevant with permanent samples. But stratification on basis of relatively stable strata such as ecological zoning may be applied to countries with pronounced differences in ecosystems such as humid and dry forests (Cameroon), desertic and non-desertic climate (Algeria), etc.
- ii) The sampling is designed to include tree resources outside forest and an array of biophysical and management/uses parameters of forest and TOF.
- iii) The approach foresees establishing sample plots to monitor changes over time between forests and other land use classes and the processes within the forests;
- iv) Biophysical data and the management and use information will be geo-referenced and integrated to enable assessing the size and state of the resources in relation to their geographic location in the country and their social context;
- v) Data quality is guaranteed and measurement methods are harmonised;

## 4.2 Sampling intensity

The sample size in this methodology is the number of sample plots where population characteristics are measured. The precision of estimates is in general closely correlated to the sample size, which as it increases, the precision of estimates increases. For equal sample size, the precision of estimates may be improved when stratification on the basis of certain variables of interest is applied. The proposed stratification on the ecological zoning is not likely to improve precision of estimates significantly but rather to apply different sampling intensity to each stratum which leads to different levels of precision among strata.

The sampling intensity proposed to survey the forest and tree resources at the national level is variable from country to country. It should be based within limits of a sample size of 50 to

500 sample sites per country. Each tract contains a cluster of 4 permanent plots of half hectare each. This is deemed to yield, at the national level, estimates of forest and land use attributes at acceptable precision. Precision of less abundant attributes decreases with the decrease of their frequency of occurrence in the country.

### 4.3. Tract and plot configuration

**a) Tract** of 1km x 1km has been chosen as the standard size to lay out a cluster of 4 independent sample plots. The tracts serve to generate forest type/land use maps from aerial photographs and very high resolution satellite data when available in the country and hence to generate areas. They are also used to collect various variables on social and forest attributes. Aerial photography taking is a costly operation even on a sample basis and recent ones are very often unavailable in the countries. Areas of forest types and land use classes can also be generated from the sample plots as shown below.

**b. Cluster layout:** The cluster sampling is statistically sound design and frequently used in forest inventories. It is employed to lower the cost of the survey. In this methodology, each cluster is composed of 4 plots placed within a tract of 1km<sup>2</sup>. The plots are strips of 20m x 250m. They are located at 250m apart from each other as shown in figure 3 below. Since the sampling is non-stratified, each plot will have one or more classes (forest, other wooded land, other land, water), depending on the heterogeneity of the site in terms of forest types/land use classes.

In order to minimise the effects from systematic or periodic variations within the surveyed populations, the 4 plots will be placed in perpendicular orientations. This is also proven practical in the fields as the field crews, during the survey, progress from the first plot to the last one without walk backwards for measurements. The way back to the road is easier to find.

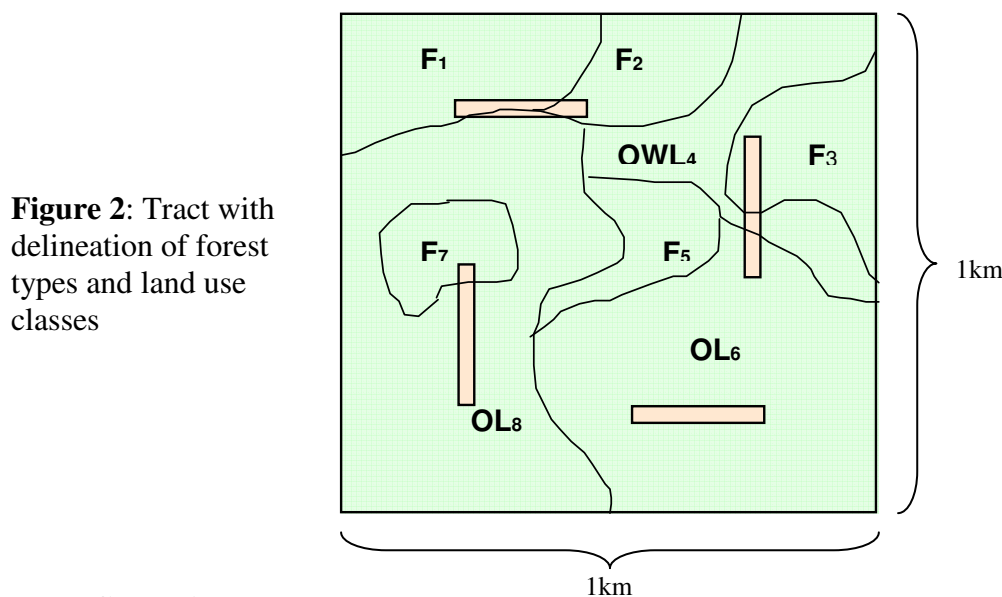

**Figure 2:** Tract with delineation of forest types and land use classes

### c. Plot configuration

Plots have dimensions of 20 x 250m (horizontal distances)

**Plot structure and measurements:**

The plot is designed to cross the maximum possible of variations within and between the classes, but long strips are discarded for practical reasons. Each plot will include nested plots in three locations. The first is centred at 5 m from the beginning of the plot, the second ones at 125m and the last at 245m. Two levels of nested plots are taken. The first consists of sample areas of 20m x 10m (200m<sup>2</sup>) for measurements of trees with DBH within the range of 10 to 30cm. The second level consists of circular sample areas of 3.99m radius or 50m<sup>2</sup> each. These small size nested plots are foreseen to records saplings of the tree species, soil information and topography (See list of variables). The location of the nested plots is shown in figure 3. In non-forest areas, the nested plots will not be materialised, and the measurements will be carried out on all trees of DBH of 10cm and above.

**Figure 3:** Plot design

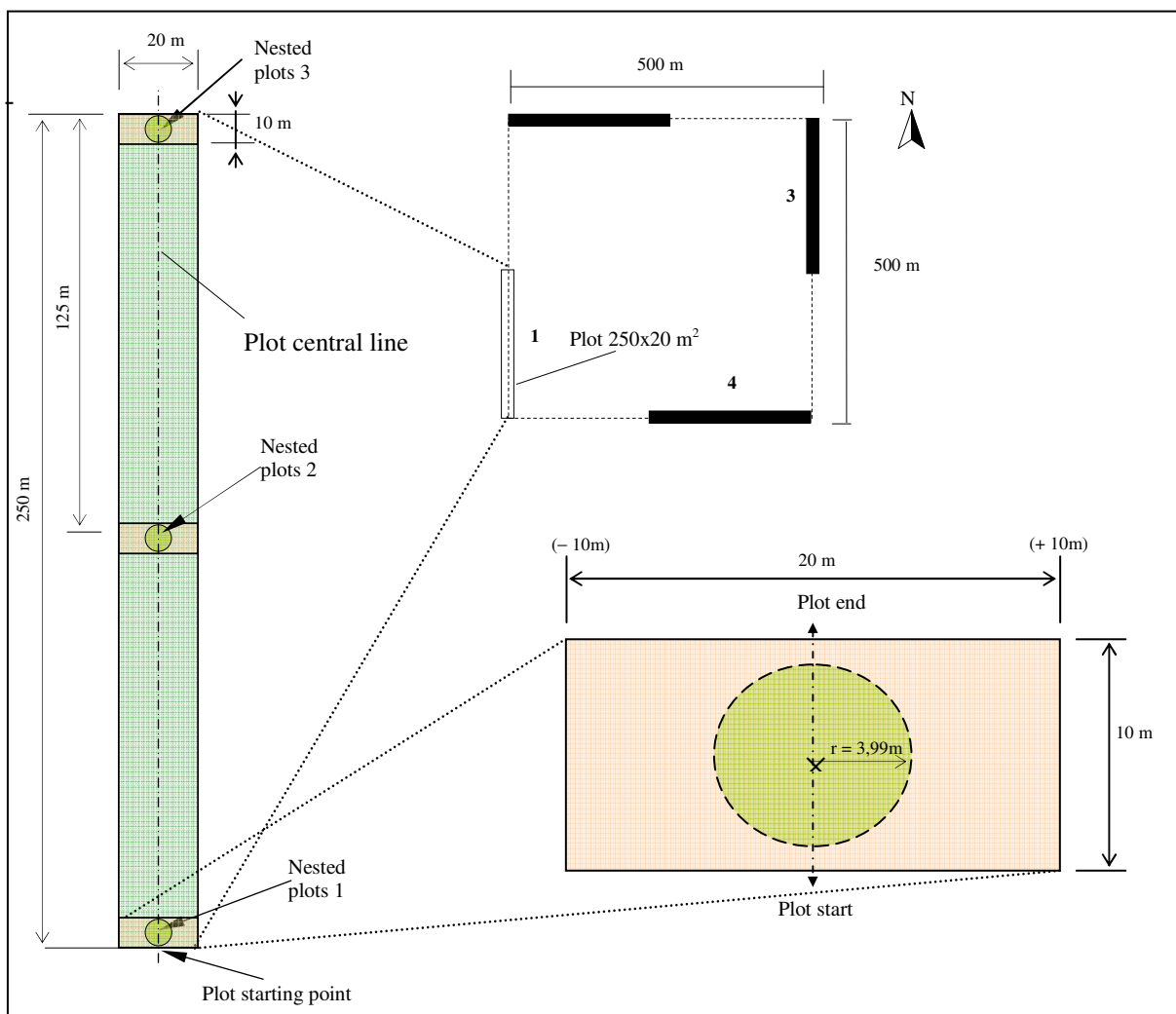

**- In forest areas:**

<u>Measurement unit</u>	<u>Trees measured</u>	<u>Unit form and maximum area</u>
- Whole plot	dbh ≥ 30cm	20x250m = (5000m <sup>2</sup> )
- Nested plot level 1	dbh ≥ 10cm and <30cm	20x10m (3 nested plots=600m <sup>2</sup> )
- Nested plot level 2	dbh <10cm and h ≥ 1.3m	r=3.99m (3 nested plots=150m <sup>2</sup> )

**- In non-forest areas:**

<u>Measurement unit</u>	<u>Trees measured</u>	<u>Unit form and area</u>
Whole plot	dbh ≥ 10cm	20x250m =(5000m <sup>2</sup> )

**d. Tree location plan**

For each permanent plot, a schema with tree location will be prepared for control and future measurements in the monitoring process. Limits of each forest type and other land use class will be identified on the ground and accurately drawn within the plot schema. Horizontal distances along X-axis and Y-axis will be measured and recorded for each tree in all forest types and land use classes falling within the plot. Distance measurements may be done along the slope and corrected to horizontal using the slope correction factors. In future surveys, changes in the land use or within the forest conditions in the plots will be mapped.

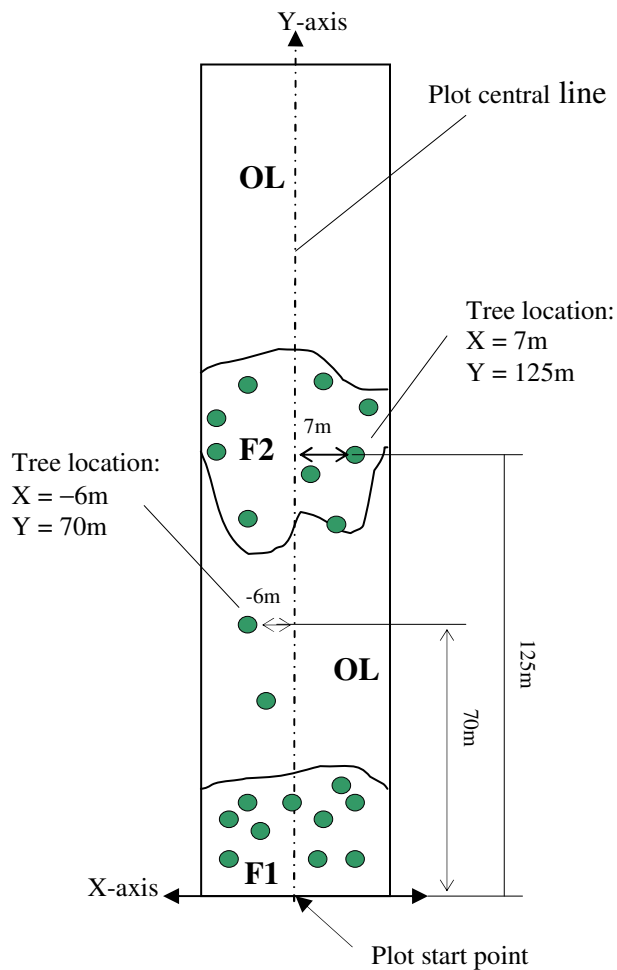

Figure 4: Tree and forest type/land use classes distribution with a plot

**Remote sensing:**

**Use of remote sensing techniques to classify vegetation and land use is optional:** If up-to-date air photos or high-resolution satellite scenes are available for the site, forest types and land use classes can be delineated to produce site map using the remote sensing technique. The areas generated from air photo interpretation will be used for area estimation. The maps serve also to lay out the sample plots and as reference base for future monitoring work.

#### 4.4. Data collection model

Variables like ecological zones, fragmentation of the forest, topography, local population and its livelihood, access and infrastructure are tied to the tract where plots are located and are part of it. Data on products and services are measured, estimated, or gathered from interviews or ocular observations from sub-plots (forest types and other land use classes) which are tied to the plot. In the case of use of aerial photography and delineation of land use classes over the whole tract, a number of resources management and use variables will be collected in the different classes found in the tract.

The tree characteristics as well as forest and TOF products/services with corresponding species and users are collected at sub-plot level corresponding to forest type or land use units in the sample plot within the tract.

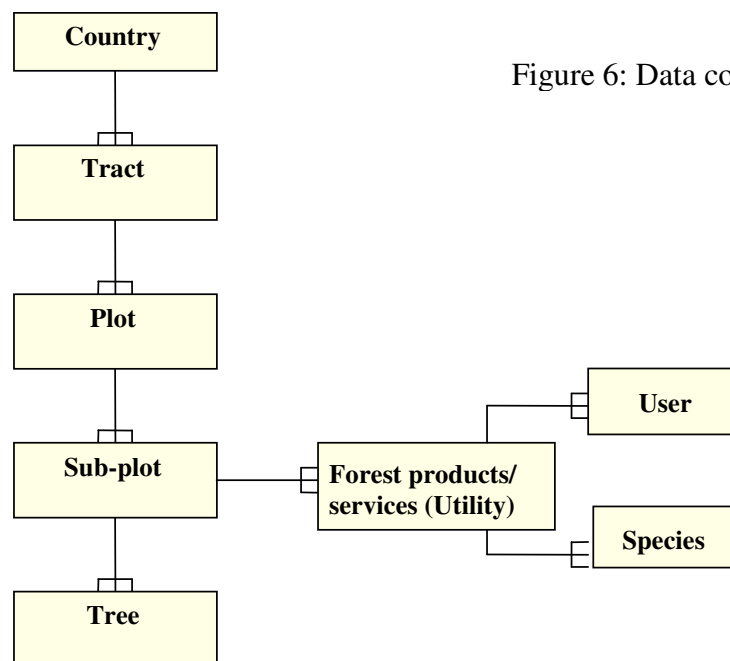

Figure 6: Data collection concept

#### 5. Variables

The long term objective of the survey is to contribute to sustainable forest and tree resources management. Three groups of variables have been defined to cover the social, economic and environmental aspects. They will enable to describe the forest and TOF resources in the country. The extent of variables is defined taking into account the need to produce different outputs in the predefined forest and tree attributes such as land use/land cover area, volume, biomass and carbon, resources management and state, biodiversity and uses of resources. The variables are also chosen to provide the necessary information for both national and global decision making. The set consists of a core of global variables that will permit to monitor and report on global issues like forest product trade, biodiversity, ecosystems, climate change, etc and a more detailed group that may still be tailored to satisfy the national information requirements. The attributes, outputs and variables are given in table 1 and in Annex 1.

Through the identified and listed variables, the inventory will provide an insight on the extent and quality of the resources, the way they are managed by Government agencies and by the local populations and to which extent these contribute into the national economy and in food security in general.

.For the purpose of national inventories of forest and tree resources, a vegetation/land use classification system has been developed on the basis of the global classes used by FRA 2000. The FRA global classes are used as a standard base to design a harmonised country classification system with the necessary desegregation that meets national information requirements and to reflect, to the extent possible, the characteristics of forest types and other land classes in the country (see classification system in Annex 2).

## 6. Outputs

The inventory methodology was designed to yield a wide range of outputs on a number of attributes. Depending on the countries needs of information, the field data can be processed to produce an undefined array of outputs. The table below gives a sample of outputs resulting from a national forest and tree inventory.

Table 1: Attributes, outputs and corresponding variables

Attributes	Outputs	Variables
<b>Land use/cover area</b>	<b>Natural forest area</b>	
	Natural coniferous forest area	Land use classes, area
	Natural broadleaved forest area	Land use classes, area
	Natural mixed forest area	Land use classes, area
	<b>Forest plantations</b>	
	Coniferous plantation area	Land use classes, area
	Broadleaved plantation area	Land use classes, area
	Mixed plantation area	Land use classes, area
	Forest area by crown cover class (open/closed canopy forest)	Land use classes, area
	Mangroves	Land use classes, area
	Primary forest area	Land use classes, area
	Secondary forest area	Land use classes, area
	Other wooded land area	Land use classes, area
	Other land cover area	Land use classes, area
	Inland water area	Land use classes, area
Forest area by ecological zone	Land use classes, area, ecological zones	
Others classes/categories areas	Land use classes, area	
<b>Volume</b>	Total volume by forest type	Height, DBH, classification
	Total volume by management type	Height, DBH, management options
	Total volume by protection status	Height, DBH, protection status options
	Total volume by ecological zone	Height, DBH, ecological zones
	Total volume of TOF	Height, DBH, classification,
	Commercial volume by forest type	Stem height, DBH, classification , timber quality
	Commercial volume management type	Stem height, DBH, management options, timber quality
	Commercial volume by species	Stem height, DBH, tree species list, timber quality
	Commercial volume by ecological zones	Stem height, DBH, species, classification, timber quality

	Commercial volume of TOF	Stem height, DBH, species, classification, timber quality
<b>Biomass &amp; Carbon</b>	Biomass in forests	Volume in forest, wood density, expansion factors
	Biomass of TOF	Volume outside forest, wood density, expansion factors
	Biomass by ecological zones	Volume by ecological zones, wood density, expansion factors
<b>Management</b>	Proportion of forest/tree resources by management system	Management options, disturbances, stand origin, silvicultural treatments, timber exploitation, silvicultural treatments, timber exploitation
	Proportion of forest under a protection status	Land use classes Designation/protection status
	Forest area by ownership	Land use classes, ownership
<b>Forest health</b>	Forest health	health options, degree of attack options, fires
<b>Biodiversity</b>	<b>Inside forest</b>	
	Communities	Tree species recorded and other sources on vegetation communities
	Occurring species	Recorded tree species occurring in the sample
	Endemic species	Tree species & additional sources on endemic species
	Threatened species	Tree species & additional sources on threatened species
	Population abundance	Tree species and frequency of species population
	Forest fragmentation	Fragmentation options
	Forest structure	Stand structure options
	human impact on natural population and habitats	Disturbances, wood and NWFP collected
	<b>Outside forest</b>	
Occurring species	Tree species occurring in the country	
Endemic species	Tree species & additional sources on endemic species	
Threatened species	Tree species & additional sources on threatened species	
Population abundance	Tree species and frequency of species population	
<b>Uses of resources</b>	<b>Non wood forest products</b>	
	Food	Products, species and parts of plants, trends of demand and supply, season and frequency of extraction, user rights, first user, end user
	Medicine	Products, species and parts of plants, trends of demand and supply, season and frequency of extraction, user rights, first user, end user
	Building material	Products, species and parts of plants, trends of demand and supply, season and frequency of extraction, user rights, first user, end user
	Crafts	Products, species and parts of plants, trends of demand and supply, season and frequency of extraction, user rights, first user, end user
	Others classes/categories areas	Products, species and parts of plants, trends of demand and supply, season and frequency of extraction, user rights, first user, end user
	<b>Wood products</b>	
	Timber	Products, species and parts of plants, trends of demand and supply, season and frequency of extraction, user rights, first user, end user
	Other wood products	Products, species and parts of plants, trends of demand and supply, season and frequency of extraction, user rights, first user, end user
	<b>Services</b>	
	Social and poverty alleviation	Cultural, spiritual, employment, recreation, Marketed products impacting economies
	Economic	Soil and water conservation ( soil texture and moisture, organic matter) landscape and topography (aspect, slope and relief), biodiversity conservation, scientific value, agriculture functions (wind breaks, shade, etc.)
	Environmental	User right of products and services, conflicts, land tenure
	<b>Use rights</b>	
	<b>Accessibility</b>	Access to sample site, distances to infra-structure (school, market, roads, hospitals)

## 7. Information system

National forest inventories produce considerable amount of data at different levels and for different purposes. A functional information system is fundamental to structure and manage the collected inventory data, store it and process it to generate the information that meets national and international requirements. Support to national forest inventories includes the development of a national information system on forest and tree resources. A global information system on forests and trees including all surveyed countries will be developed.

The base for the information system will be a well-structured database, which will include various levels of internal relations. An undefined number of analyses can be carried out on the stored data. The system will permit storage of data from sequential surveys in order to detect and estimate changes and establish trends. The information system should therefore be a base for historic database, up-dated information and for changes and trend analysis. The system will enable reporting on global and national issues.

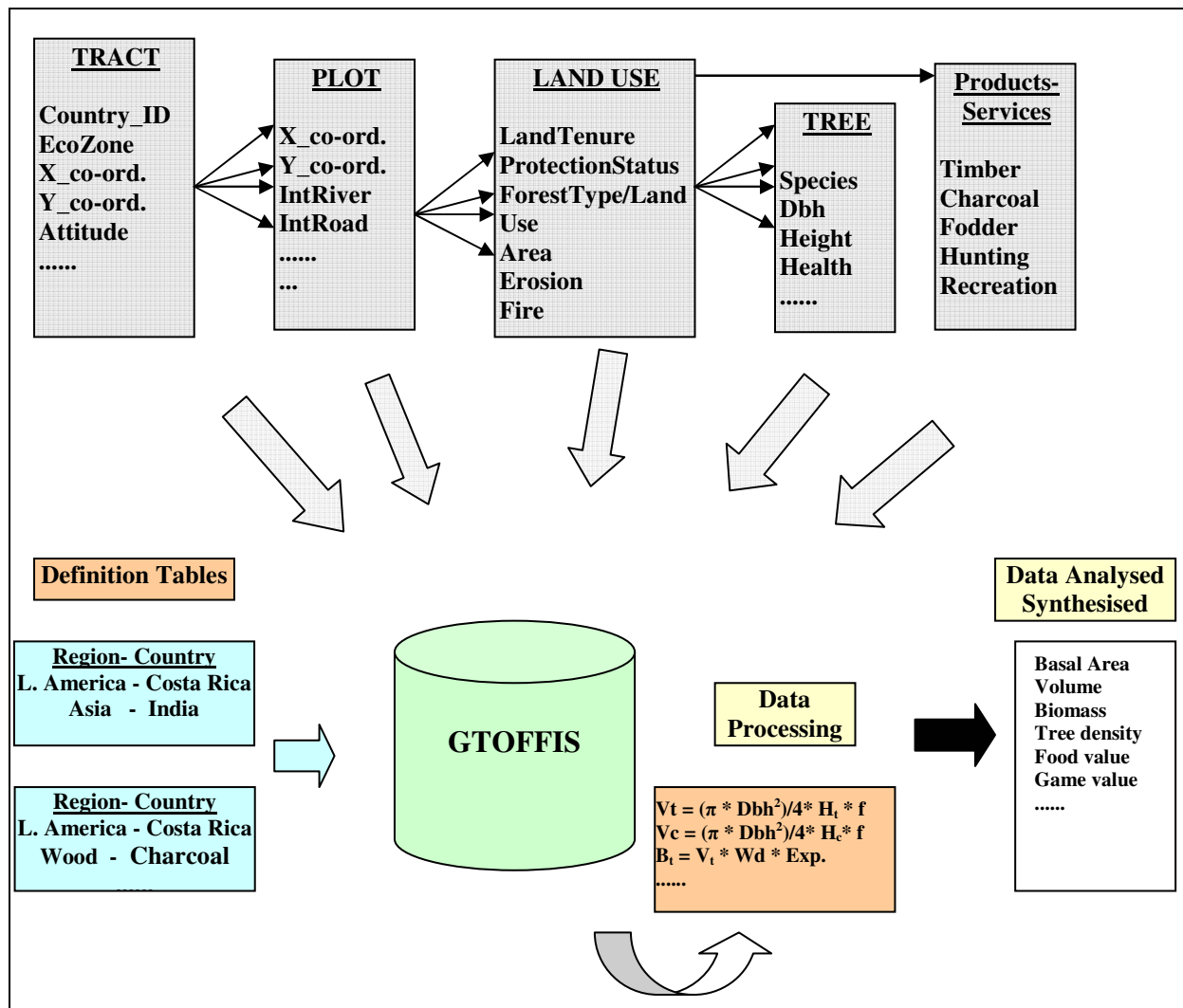

## **8. Overall approach and arrangements**

In line with the goal of the national capacity building effort, the approach was designed to be implemented by a national team. Design, planning and field implementation of the project activities are to be carried out by a group of national foresters with assistance provided by FAO. FAO would therefore take the coordinating and facilitating role in the process. It would assist in the development of methodology, seek funding and partners, help countries to build up their capacities to survey the forest and TOF resources and manage the generated information.

Through FRA programme, the regional offices and its representations in the countries, FAO would work with the countries to make the national forest inventory in the countries a fully participatory exercise. National steering committee would be formed and ensures participation of national institutions by their know-how and background information. The committee will ensure best use of the inventory results. A national coordinator would be nominated to oversee and co-ordinate the project activities.

## **References**

- Lee White et Ann Edwards, 2000.** Conservation en forêts pluviale africaine, Méthodes de recherche. The Wildlife Conservation Society, New York, USA.
- Ir P.J.D. Versteegh, 1976.** Statistics in Forestry, Part II, Inductive Statistics, International institute for Aerial survey and Earth Science, ITC, The Netherlands.
- Holmgren P. & Persson R. 2002.** Why did we end up here? – The evolution of global forest assessments, *Unasylva* 210
- Michael Kohl and Risto Paivinen, 1996.** Definition of a system of nomenclature for mapping European forests and for compiling a pan-European forest information system. Joint Research Centre, European Commission and European Forest Institute.
- Kleinn C., Ramirez C., Chaves G. & Lobo S, 2000.** Pilot forest inventory in Costa Rica. Report to FAO FRA
- Journal of Forestry, 1999, Volume 97.** Forestry Inventory and Analysis. USA.

## Annex 2: Vegetation classification system

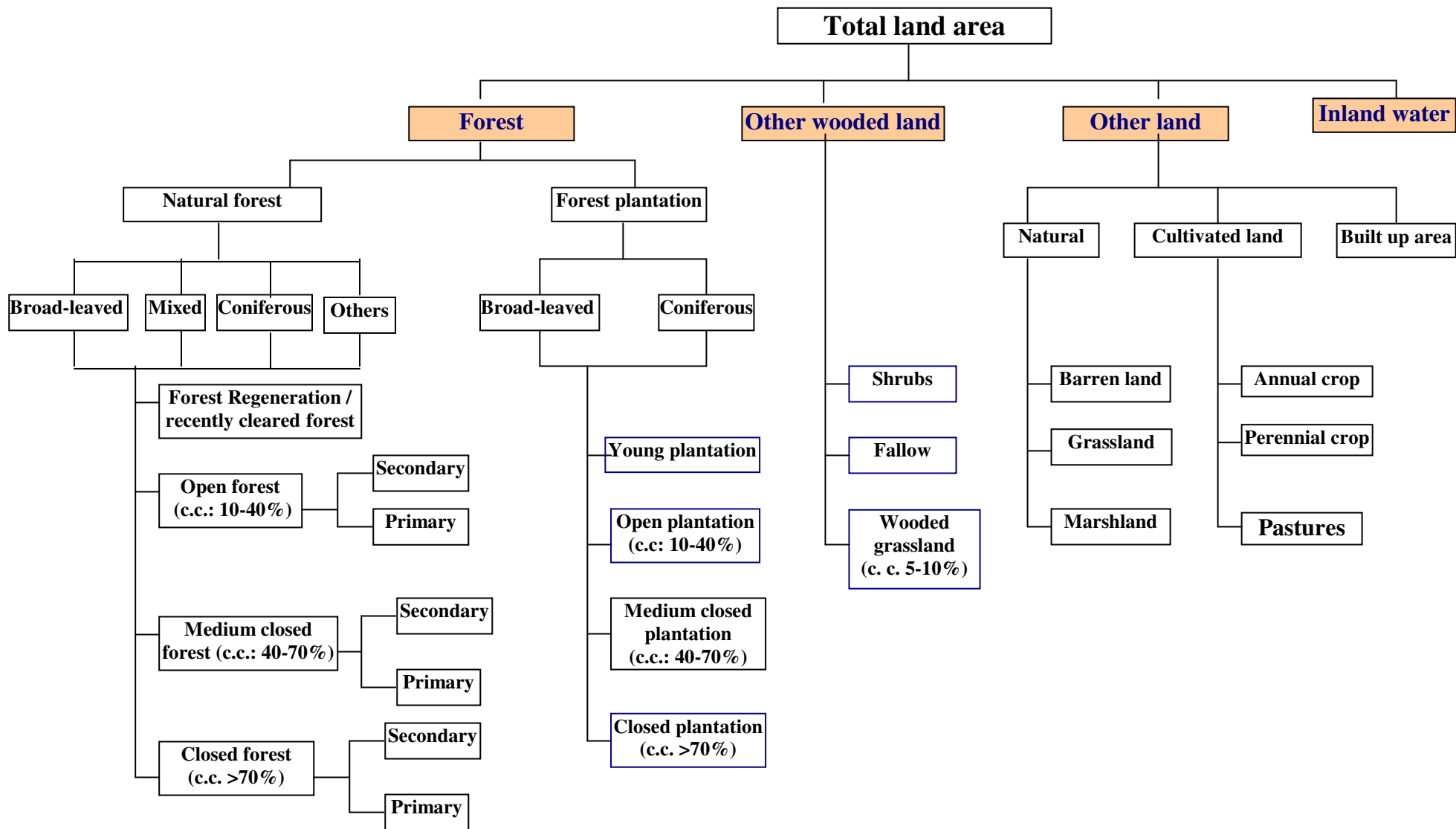

### Legend

FBØ:	Regeneration of natural broad-leaved forest
FB1P:	Primary open broad-leaved forest (cc: 10-40%)
FB1S:	Secondary open broad-leaved forest (cc: 10-40%)
FB2P:	Primary medium closed broad-leaved forest (cc: 40-70%)
FB2S:	Secondary medium closed broad-leaved forest (cc: 40-70%)
FB3P:	Primary closed broad-leaved forest (cc: >70%)
FB3S:	Secondary closed broad-leaved forest (cc: >70%)
FMØ:	Regeneration of natural mixed forest
FM1P:	Primary open mixed forest (cc: 10-40%)
FM1S:	Secondary open mixed forest (cc: 10-40%)
FM2P:	Primary medium closed mixed forest (cc: 40-70%)
FM2S:	Secondary medium closed mixed forest: (cc: 40-70%)
FM3P:	Primary closed mixed forest (cc: >70%)
FM3S:	Secondary closed mixed forest (cc: >70%)
FCØ:	Regeneration of natural coniferous forest
FC1P:	Primary open coniferous forest (cc: 10-40%)
FC1S:	Secondary open coniferous forest (cc: 10-40%)
FC2P:	Primary medium closed coniferous forest (cc: 40-70%)
FC2S:	Secondary medium closed coniferous forest (cc: 40-70%)
FC3P:	Primary closed coniferous forest (cc: >70%)
FC3S:	Secondary closed coniferous forest (cc: >70%)
PBØ:	Young broad-leaved forest plantation
PB1:	Open broad-leaved forest plantation (cc: 10-40%)
PB2:	Medium closed broad-leaved forest plantation (cc: 40-70%)
PB3:	Closed broad-leaved forest plantation (cc: >70%)
PCØ:	Young coniferous forest plantation
PC1:	Open Coniferous forest plantation (cc: 10-40%)
PC2:	Medium closed coniferous forest plantation (cc: 40-70%)
PC3:	Closed coniferous forest plantation (cc: >70%)
Sh:	Shrubs
Fa:	Fallow
WGL:	Wooded grassland (cc: 5-10%)
BL:	Barren land
GL:	Grassland
ML:	Marshland
AC:	Annual crop
PC:	Perennial crop
Pa:	Pastures
BUA:	Built-up areas
IW:	Inland water