

Annex 1

Estimating soil hydrological characteristics from soil texture and structure

It is possible to derive rough estimates of the hydraulic conductivity (K) and the drainable pore space (μ) from observations of the soil profile. This is because these soil hydraulic qualities depend on soil texture and structure. Table A1.1 average presents μ values, compiled by FAO (1980) and based on data from the USBR (1984), together with K values estimated from the μ/K relationship. For soils with distinct horizontal layers, the vertical K may be taken as being at least 10 and on average 16 times lower than the horizontal one.

As these estimates may be imprecise, more realistic K values are obtained through field measurements, as described in Annex 3.

However, interpreting the soil structures mentioned in Table A1.1 may not be easy. It should be done through observations of soil profiles, but shallow groundwater levels often prevent excavation of soil pits. Moreover, soil texture and structure should be evaluated when the soil is moist throughout.

However, in special cases, it is possible to estimate drain spacings directly from the visual aspects of the soil profile, as was done by people with detailed local experience in the Zuiderzee polders, the Netherlands, where it was the only possible method – drain spacings of 8, 12, 16, 24, 36 and 48 m were distinguished and the choice between possibilities was possible.

For pure sands (almost without clay and silt), an estimate is:

$$K = \frac{m_{50}^2}{2000}$$

where:

K = permeability (m/d).

m_{50} = median size of grains above 50 μm . Half of the weight is above this size, half below.

TABLE A1.1
 K and μ values according to the soil texture and structure

Texture (USDA) ¹	Structure	μ	K (m/d)
C, heavy CL	Massive, very fine or fine columnar	0.01–0.02	0.01–0.05
	With permanent wide cracks	0.10–0.20	> 10
C, CL, SC, sCL	Very fine or fine prismatic, angular blocky or platy	0.01–0.03	0.01–0.1
C, SC, sC, CL, sCL, SL, S, sCL	Fine and medium prismatic, angular blocky and platy	0.03–0.08	0.1–0.4
Light CL, S, SL, very fine sL, L	Medium prismatic and subangular blocky	0.06–0.12	0.3–1.0
Fine sandy loam, sandy loam	Coarse subangular block and granular, fine crumb	0.12–0.18	1.0–3.0
Loamy sand	Medium crumb	0.15–0.22	1.6–6.0
Fine sand	Single grain	0.15–0.22	1.6–6.0
Medium sand	Single grain	0.22–0.26	> 6
Coarse sand and gravel	Single grain	0.26–0.35	> 6

¹ C: clay; L: loam; S: silt; s: sand.

Source: Adapted from FAO, 1980, with further elaboration.

The presence of silt ($< 50 \mu\text{m}$) and especially clay ($< 2 \mu\text{m}$) will lower this value considerably. Therefore, this formula should not be used for such soils.

REFERENCES

- FAO.** 1980. *Drainage design factors*. FAO Irrigation and Drainage Paper No. 38. Rome. 52 pp.
- USBR.** 1984. *Drainage manual*. A Water Resources Tech. Publication. Second printing. Denver, USA, US Dept. of Interior, Bureau of Reclamation. 286 pp.

Annex 2

Statistical analysis of extremes

GUMBEL'S METHOD

The Gumbel distribution can be used for extrapolating from a limited number of extreme values (Gumbel, 1954 and 1958). The basic data appear in groups, such as the daily rainfall in August (31 days per year), or the water levels in a river per year (365/366 days). The highest value in such a group is the extreme. The groups should contain at least ten elements, and the minimum number of extremes (often years) is at least ten.

The method assumes that the underlying process remains constant. This supposition is doubtful because of recent climate changes, which also influence data such as river flows. These changes are especially noticeable in the extreme values. Therefore, the method should be used with care.

Extreme values are obtained as follows:

- Select the highest (sometimes lowest) value in a group, e.g. the highest autumn rainfall or the highest river discharge in a year. Each group should contain at least ten values.
- These extremes are sorted according to their magnitude in order to prepare for further analysis.

The probability that a certain value x does not exceed a limit x_0 is:

$$P(x \leq x_0) = \Phi(y) = \exp[-\exp(-y)] \quad \text{with} \quad y = \alpha(x_0 - u) \quad (1)$$

where:

P = probability;

n = number of extremes;

u = constant (shift);

x = values of the extremes. The average is \bar{x} the standard deviation is s_x ;

x_0 = limiting value;

y = reduced Gumbel variable, with average c and standard deviation s_y . For y and for a very large number of observations, $c = 0.57722 = \text{Euler's constant}$;

α = constant (slope).

The probability that x exceeds x_0 is:

$$P(x > x_0) = 1 - \Phi(y) \quad (2)$$

The return period T is the number of groups in which the limit x_0 is exceeded. If there is one group per year, T is in years (as in the above examples). T is defined as:

$$T = \frac{1}{1 - \Phi(y)} \quad (3)$$

For the x values, the procedure is:

$$\bar{x} = \frac{\sum x}{n}$$

$$s_x = \sqrt{\frac{\sum x^2 - \frac{(\sum x)^2}{n}}{n-1}}$$

$$s_y = \frac{\pi}{\sqrt{6}} = \text{standard deviation of } y.$$

Table A2.1 shows the values derived by Kendall for a smaller number of observations.

The line $y = \alpha(x - u)$ has two parameters: the slope α , and the shift u . They can be found by plotting on Gumbel probability paper, usually with the return period T on the horizontal axis, the value of the extremes on the vertical. The line may be drawn visually through the points to allow extrapolation. In this way, the once-per-century rainfall or the river discharge can be estimated. This is even possible for much longer return periods.

The program GUMBEL calculates the parameters automatically and provides estimates for the extremes to be expected with a certain return period.

For agricultural drainage design, a return period of 2–10 years is often taken, 2–5 years for field drainage and even 10 years for crop systems with high planting costs, and 5–10 years for the main system where it does not affect inhabited places.

By extrapolation, a prediction can be given over much longer periods of time in order to obtain estimates for values to be expected once in 100 years (the once-per-century value) and even for much longer times. However, the uncertainty of the estimates becomes very large for such longer return periods. Moreover, for such periods (and even for a century), the basic data series cannot be considered as constant, owing to human and geological influences.

Nevertheless, such a prediction is valuable for engineering purposes, e.g. the height of a river embankment able to withstand a “100-year flood”. This will almost certainly

not occur 100 years later, but it has a chance of 1 percent of occurring next year.

The influence of climate changes can be analysed by comparing data from the last 10–20 years with earlier ones (where available), and it is wise to employ the worst prediction. Where not different, the basic data include recent changes already.

TABLE A2.1
Values of c and s_y as a function of n

n	c	s_y
10	0.495	0.950
15	0.513	1.021
20	0.524	1.063
25	0.531	1.092
30	0.536	1.112
40	0.544	1.141
50	0.548	1.161

REFERENCES

- Gumbel, E.J. 1954. *Statistical theory of extreme values and some practical applications*. Applied mathematics series 33. U.S. Dept. of Commerce, National Bureau of Standards.
- Gumbel, E. J. 1958. *Statistics of extremes*. New York, USA, Columbia Press.

Annex 3

Field methods for measuring hydraulic conductivity

INTRODUCTION

The K value can be measured directly in the soil layers situated below the groundwater level using the methods described below. Less reliable methods are used to estimate the saturated hydraulic conductivity above this level. For well-moistened granular soils, the soil permeability for saturated flow can be estimated from the capillary hydraulic conductivity of the unsaturated zone. However, this is not the case in well-structured soils where this permeability is caused by cracks, holes or other macropores. Infiltrometer or inverse auger-hole methods are often used as a compromise. They measure conductivity under “almost saturated” conditions.

The field methods for determining K are based on a basic principle: water flows through a volume of soil, whose boundary conditions are known, and the discharge is measured; the K value is calculated by applying an equation derived from Darcy’s Law applied to the specific geometry of the soil volume.

The following paragraphs review the suitability of the field methods most commonly used to measure the soil hydraulic conductivity (auger-hole, piezometer, and inverse auger-hole). The methods are different according to the groundwater depth at the time of measurement. Details on these methods can be found in the bibliographic references (Van Hoorn, 1979; USBR, 1984; Oosterbaan and Nijland, 1994; Amoozegar and Wilson, 1999).

AUGER-HOLE METHOD FOR DETERMINING SOIL PERMEABILITY

The auger-hole method (Van Beers, 1983) is the most suitable way of measuring the K value of saturated homogeneous soils down to a depth of about 3 m. It is based on the relationship between the K value of the soil surrounding a hole and the rate at which the water level rises after pumping. The method measures the saturated permeability in a rather large volume, which is an advantage in view of the large variability in natural soils.

Method

This method for determining the soil hydraulic conductivity (Figure A3.1) consists of the following steps:

1. Make a hole of known depth with a soil auger of known diameter to a depth of at least 50 cm below the water table. In unstable soils (e.g. sand), a perforated filter may be needed to support the walls.
2. Find or estimate the depth of any impermeable soil layer. If more than 100 cm below the bottom of the hole, assume an infinite depth.

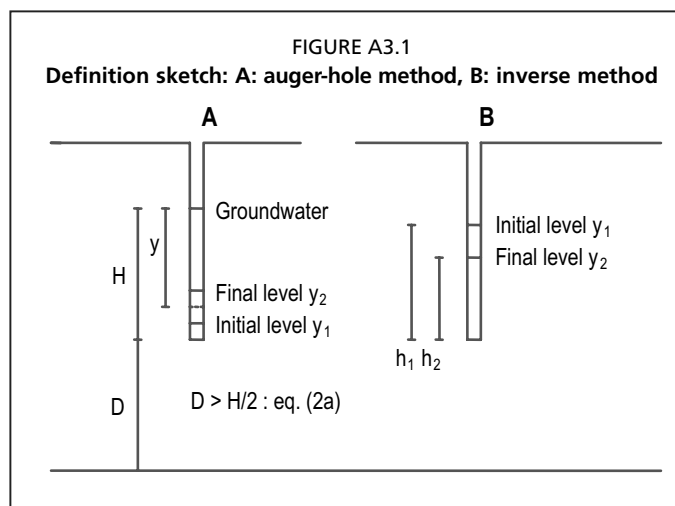

3. Pump water out (e.g. with a bailer) several times and let that water flow back into the hole.
4. Let the groundwater (where present) fill the hole until equilibrium. For impermeable soils, return the next day; for permeable soils, a few hours are sufficient (sometimes even a few minutes).
5. Measure the groundwater depth below soil surface.
6. Pump water out.
7. Measure the rise of the water level over time. Time intervals should be short initially.

Example

The following data can be considered:

- Depth of 8-cm diameter hole: 150 cm;
- Groundwater at equilibrium: 50 cm;
- Water level, first measurement: 85–83 cm, $\Delta t = 20$ s;
- Water level, second measurement: 80–78 cm, $\Delta t = 24$ s;
- Water level, third measurement: 70–68 cm, $\Delta t = 31$ s;
- Impermeable base: deep (300 cm).

From these data (all distances below soil surface), the average permeability K follows. This value is the mean value (mainly horizontal) between the groundwater table and a few centimetres below the bottom of the hole.

It should be noted that:

- The permeability of different layers can be found from measurements in holes of different depths, but this is not very reliable; the piezometer method is better.
- The first measurement may deviate because water is still running off the wall; in this case, it should be discarded.
- Measurements soon after lowering by pumping the water out are preferred.

The above methods cannot be used without an existing groundwater table at the time of measurement. The following methods can be used in such cases. However, they are less reliable.

The inverse method, also known as the Porchet method, may be also applied to determine the saturated hydraulic conductivity above the groundwater level. In this case, water is poured into an augered hole and the rate of lowering of the water level inside the hole is measured (Figure A3.1). The measurements are taken after water has been infiltrating for a long time until the surrounding soil is sufficiently saturated (in order to diminish the effect of unsaturated soil on the rate of drawdown). The equation used to calculate the K value has been derived from the balance between the water flowing through the side walls and bottom of the hole, and the rate of lowering of the water level in the hole. The basic assumption is that the flow gradients are unity. Although less reliable than the measurements using an existing water table, it is often necessary where measurements must be made outside a wet period in dry soils. However, many dry soils swell so slowly that their permeability can only be reliably measured by the auger-hole method during the wet season.

Van Hoorn (1979) made a comparison between normal and inverse methods and found reasonably corresponding values for K , thus confirming the assumption about the gradient.

Theory

According to Ernst and Westerhof (1950), Van Beers (1983) and Oosterbaan and Nijland (1994), for the auger-hole method, the saturated soil permeability is calculated using:

$$K = C \frac{dy}{dt} \quad (1)$$

in which:

$$C = \frac{4000 \frac{r}{\bar{y}}}{\left(\frac{H}{r} + 20\right) \left(2 - \frac{\bar{y}}{H}\right)} \quad (2a)$$

where the bottom of the hole is far above the impermeable base ($D > H/2$), or:

$$C = \frac{3600 \frac{r}{\bar{y}}}{\left(\frac{H}{r} + 10\right) \left(2 - \frac{\bar{y}}{H}\right)} \quad (2b)$$

where the bottom of the hole reaches the impermeable base ($D = 0$). In these formulae:

- C = constant, depending on hole geometry;
- dy/dt = rate of rise in water level (cm/s);
- D = depth of impermeable layer below bottom (cm);
- $b = H - y$ = height of water column (cm);
- b_1, b_2 = initial and final water column in hole (cm);
- H = depth of borehole below groundwater (cm);
- K = average soil permeability (m/d);
- r = radius of borehole (cm);
- t = time (s);
- y = depth of water level below groundwater (cm);
- \bar{y} = average value of y in the interval where $y > 3/4y_0$ (cm);

$$\frac{dy}{dt} \approx \frac{y_1 - y_2}{t_2 - t_1} \quad y_1 > y_2; t_2 > t_1 \quad (3)$$

Where the impermeable base is close to the bottom of the hole, an interpolation between Equations 2a and 2b is used.

For the inverse method, Oosterbaan and Nijland (1994) recommend:

$$K = \frac{r}{2(t_2 - t_1)} \ln \frac{b_1 + \frac{r}{2}}{b_2 + \frac{r}{2}} \quad b_1 > b_2; t_2 > t_1 \quad (4)$$

which was derived analytically by integration of the following differential equation:

$$\frac{db}{b + \frac{r}{2}} = -\frac{2K}{r} dt \quad (5)$$

In Equation 4, the value of K is expressed in centimetres per second. To convert K from centimetres per second to metres per day, it should be multiplied by the factor 864.

The results within the same auger hole are usually quite consistent, but between different holes, even nearby ones, differences may be considerable owing to local soil variations. However, in predicting drain spacings, these differences become less

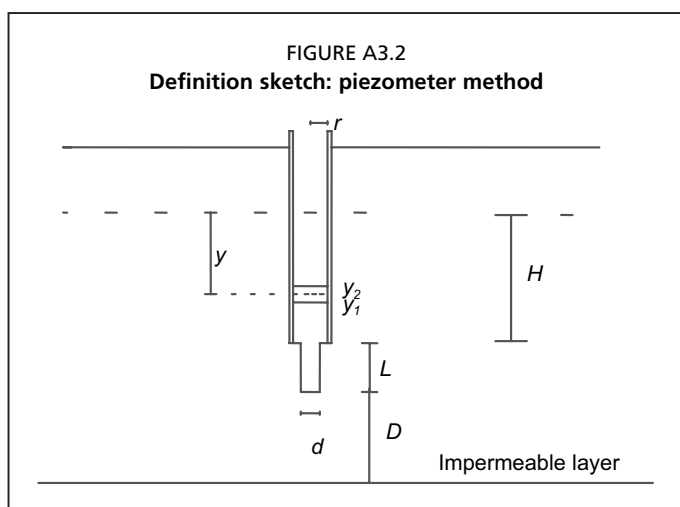

important because the calculated spacings are proportional to the square root of K .

The program AUGHOLE makes the necessary calculations according to the above formulae.

The resulting K values can be used as input in programs for calculating drain spacings.

PIEZOMETER METHOD FOR DETERMINING SOIL PERMEABILITY

The piezometer method is more convenient than the auger-hole method for measurements of the K value in stratified soils and in layers

deeper than 3 m. In these cases, water is pumped out of a piezometer, of which only the lowest part is open, while the upper part of the hole is protected by a pipe. The rate of rise in the water level inside the tube is measured immediately after pumping. Therefore, the K value of the small layer of soil near the open part is determined.

Method

The piezometer method (Luthin and Kirkham, 1949) differs from the auger-hole method in that the upper part of the hole is covered by a non-perforated pipe (Figure A3.2). The lower part of the borehole is open and collects the water from a specific layer. In this way, the permeability of separate layers can be found easily.

The procedure is as follows:

1. Make an auger hole and cover the upper end with a tightly fitting pipe, while the remaining open part acts as the water-collecting cavity, or cover the entire hole and make a narrower cavity below the pipe with a smaller auger.
2. Measure the groundwater depth at equilibrium.
3. Pump some water out and measure the rise in water level at different times.

It is most convenient to take all measurements with reference to the top of the protecting pipe. The computer program PIEZOM is based on Kirkham's formula. It calculates the permeability K (in metres per day) from these observations and the geometric factors.

Theory

The basic formula is:

$$K = \frac{864m^2}{A\Delta t} \ln \frac{y_1}{y_2} \quad (6)$$

where A is a factor depending on the geometry of the piezometer and the hole below the end of the piezometer and 864 a constant for converting centimetres per second (for K) to metres per day. Various authors (Luthin and Kirkham, 1949; Smiles and Youngs, 1965; Al-Dhahir and Morgenstern, 1969; Youngs, 1968) have provided graphs or tables for A . Except for very small distances between the top of the piezometer and groundwater (and within certain limits), the tables for A/d given by Youngs (1968) (with the necessary corrections for diameter rather than radius) may be approximated by empirical formulae for the two limiting cases and for the "standard" value $H = 8d$:

$$\frac{A_s}{d} = 4.40 \left(\frac{L}{d} \right)^{0.661} + 2.6 \quad (7a)$$

where the bottom of the cavity hole is at the impermeable base, and:

$$\frac{A}{d} = 4.40 \left(\frac{L}{d} \right)^{0.661} + 0.2 - 0.06 \left(\frac{L}{d} - 1 \right) \quad (7b)$$

where the bottom of the cavity hole is far above the impermeable base (more than four times the cavity diameter). For H/d less than eight, rather complicated corrections are made to obtain A/d .

For H/d greater than ten, no values are tabulated. As an approximation, it is supposed that for $H/d > 8$ the cylindrical cavity may be represented by a sphere and that the remaining flow is radial. For this part of the flow, the inner radius is $r_s = 8d + L/2$, whereas the outer radius is taken as the depth of the cavity centre below the groundwater level, $H + L/2$. These approximations are used in the program PIEZOM; the corrections are small because most of the resistance to flow occurs immediately around the cavity. They are:

$$\frac{A}{d} = \frac{A_s (1/r_o - 1/r_s)}{d (1/r_o - 1/r^*)} \quad (8)$$

where:

$$r_o = \frac{1}{4\pi / A_s + 1/r_s} \quad (9a)$$

$$r_s = 8d + L/2 \quad (9b)$$

$$r^* \approx H + L/2 \quad \text{for } H > 8d \quad (9c)$$

In these formulae (see Figure A3.2):

A = factor depending on shape (cm);

A_s = same, for $H = 8d$;

d = diameter of cavity (cm);

H = depth of top cavity below groundwater (cm);

K = permeability (m/d);

L = length of cavity (cm);

r = radius of protecting pipe (cm);

r_o = radius of sphere equivalent to cavity (for $H > 8D$) (cm);

r_s = radius $8d$ beyond which flow is supposed to be radial (cm);

r^* = distance centre of cavity to surface, to be used if $H/D > 8$ (cm);

D = distance to impermeable layer from cavity bottom (cm);

t = time (s);

y = water level below groundwater (cm);

y_1, y_2 = initial and final value of y (cm);

π = 3.14...

REFERENCES

- Al-Dhahir, Z.A. & Morgenstern, N.R. 1969. Intake factors for cylindrical piezometer tips. *Soil Sci.*, 107: 17–21.
- Amoozegar, A. & Wilson, G.V. 1999. Methods for measuring hydraulic conductivity and drainable porosity. In R.W. Skaggs & J. Van Schilfgaarde, eds. *Agricultural drainage*, pp. 1149–1205. Agronomy Series 38. Madison, USA.
- Ernst, L.F. & Westerhof, J.J. 1950. *A new formula for the calculation of the permeability factor with the auger hole method*. Translated from the Dutch by H. Bouwer (1955). Ithaca, USA, Cornell University.
- Luthin, J.N. & Kirkham, D. 1949. A piezometer method for measuring permeability of soil in situ below a water table. *Soil Sci.*, 68: 349–358.
- Oosterbaan, R.J. & Nijland, H.J. 1994. Determining the saturated hydraulic conductivity. In H.P. Ritzema, ed. *Drainage principles and applications*, pp. 435–475. 2nd edition. ILRI Publication 16. Wageningen, The Netherlands, ILRI.
- Smiles, D.E. & Youngs, E.G. 1965. Hydraulic conductivity determinations by several field methods in a sand tank. *Soil Sci.*, 99: 83–87.
- USBR. 1984. *Drainage manual*. A Water Resources Tech. Publication. Second printing. Denver, USA, US Dept. of Interior, Bureau of Reclamation. 286 pp.
- Van Beers, W.F.J. 1983. *The auger-hole method; a field measurement of the hydraulic conductivity of soil below the watertable*. 6th edition. ILRI Bulletin 1. Wageningen, The Netherlands, ILRI.
- Van Hoorn, J.W. 1979. Determining hydraulic conductivity with the inversed auger hole and infiltrometer methods. In J. Wesseling, ed. *Proceedings of the International Drainage Workshop*, pp. 150–154. ILRI Publication 25. Wageningen, The Netherlands, ILRI.
- Youngs, E.G. 1968. Shape factors for Kirkham's piezometer method for soils overlying an impermeable bed or infinitely permeable stratum. *Soil Sci.*, 106: 235–237.

Annex 4

Determining drainable soil porosity

ESTIMATIONS FROM A pF CURVE

One option is to estimate the μ value on a pF curve as the difference in the water content by volume at saturation and at field capacity. This procedure has an important drawback because of the differences between a small undisturbed soil sample and the actual field conditions. However, an estimated average value of μ can be obtained where several laboratory measurements are taken for the same soil layer.

ESTIMATIONS FROM PERMEABILITY

Another option is to estimate the μ value from empirical relationships between the macroporosity and the hydraulic conductivity. Figure A4.1 shows the relationships developed by Van Beers (ILRI, 1972) and the USBR (1984) and those obtained by Chossat and Saugnac (1985) for soils with different clay contents.

However, as there are large variations, the field methods described below may be preferable.

OBSERVATIONS OF GROUNDWATER-LEVEL VARIATIONS

A better method is to measure the rise in groundwater level at short intervals, for example, before and soon after a heavy rain of short duration. The rainfall is divided by the observed rise, both expressed in the same units. If a sudden rain of 20 mm and no runoff causes a rise of 40 cm = 400 mm, $\mu = 20/400 = 0.05$ (5 percent).

In drained lands, the fall in a rainless period can also be used, in combination with drain outflow measurements, as described in Annex 8.

LARGE CYLINDER

A more laborious method uses a large cylinder of undisturbed soil, carefully dug out. An oil drum (without its bottom) pushed tightly over the remaining column of soil is suitable for the purpose. After taking out, a new bottom is made by sealing the container to a plastic plate or welding it to a steel one. Water is added, and the water table rise inside is measured.

REFERENCES

Chossat, J.C. & Saugnac, A.M. 1985. Relation entre conductivite hydraulique et porosite de drainage mesurees par la methode du puits et des piezometres. *Sci. du Sol*, 1985/3.

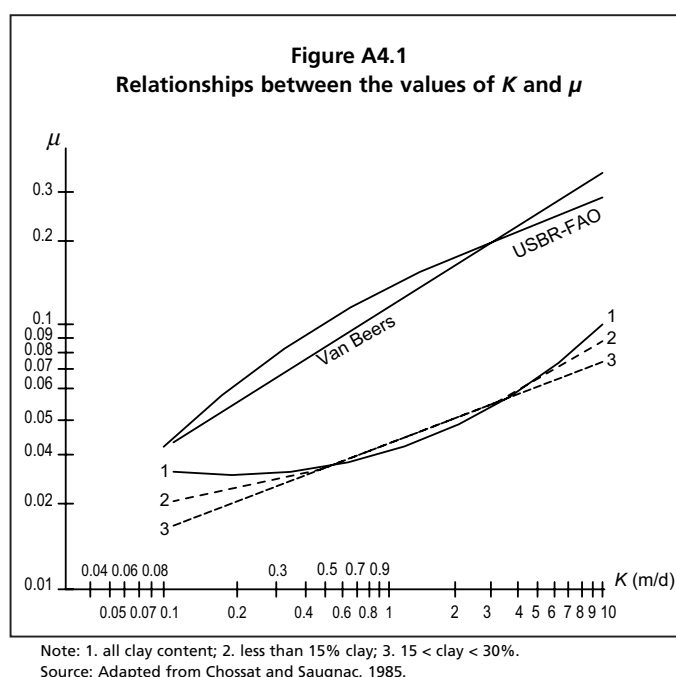

- ILRI.** 1972. *Fieldbook for land and water management experts*. Wageningen, The Netherlands.
- USBR.** 1984. *Drainage manual*. A Water Resources Tech. Publication. Second printing. Denver, USA, US Dept. of Interior, Bureau of Reclamation. 286 pp.

Annex 5

Determining other soil hydrological characteristics

DEPTH TO IMPERVIOUS BARRIER

The position of an impermeable base (bedrock or tight clay) can be found from borings or soundings, or by geophysical methods. The existence of an impervious or slowly permeable soil layer can be commonly identified by observations in an auger hole where the barrier occurs within the depth of the hole, for example, when a net change in the soil texture or a sharp increase in the soil compactness is observed and, specifically, where a relatively dry material is found below a layer saturated with water. However, it is not always easy to distinguish an impervious layer. In this case, a layer can be considered as such if its hydraulic conductivity (K) is less than one-tenth of the permeability of the overlying layer.

Where the impervious layer is not within the depth range of the auger hole, deep borings must be carried out. Although cumbersome, hand augerings to 8–10 m are possible in moist soils. Where this is not possible or does not give a result, the depth can be estimated from soil maps or geological maps. Existing deep-water wells, or logs from drilled wells, may provide indications of the depth. Other solutions can be found in rough estimates of the aquifer transmissivity as described below.

THICKNESS OF THE FLOW REGION

In very deep homogeneous soils or aquifers, the lateral flow of groundwater tends to be concentrated in the upper part, to a depth about one-third of the distance between source and sink. In anisotropic aquifers ($K_v < K_h$), the active flow depth is even less. Thus, the flow in a drained field with 20-m drain spacing, would be concentrated in the upper 7 m, whereas flow from a hill to a valley, over a distance of 1 km mostly takes place in the upper 300 m (although aquifers are seldom so thick). Such figures form the upper limit of the “equivalent layer” (Hooghoudt, 1940).

The presence of an impermeable soil layer at a greater depth will not have a significant effect on the flow. On the other hand, at shallower depth, the influence becomes noticeable. The difference between real thickness and equivalent thickness is large at first for wide drain spacings, but it becomes less as the aquifer becomes thinner, until finally both become almost equal.

However, in drained fields, aquifers may be much thicker than one-third of the distance between drains. Here, the equivalent thickness (d) is taken. This adjustment is necessary because of the change from an almost horizontal flow through the aquifer to a radial flow near the drain. Consequently, the streamlines are concentrated there, leading to extra “radial resistance” and, thus, a smaller “equivalent” layer thickness, with one-third of the spacing as a maximum. Deeper parts of the aquifer hardly contribute to the flow entering the drain.

However, in thin aquifers, the water flow above the drain level is also relevant and it cannot be ignored. Then, $D = D_i + d$, D_i being the average thickness of the flow region above drain level. In some cases, as in many flat deltaic areas at or slightly above sea level with unripened clay subsoils (e.g. the Guadalquivir Marshes in Spain, the lower part of the Nile Delta in Egypt, and the Zuiderzee polders in the Netherlands), drains are laid on the impervious layer and, consequently, water flows only above drain level.

AQUIFER TRANSMISSIVITY

The transmissivity of an aquifer is the product of permeability and thickness (KD). In regional groundwater flow, the distances are so large (mostly several kilometres) that the entire thickness of the aquifer can be taken. In almost all cases, it will be thin in comparison with one-third of this distance, so that the real thickness can be taken for D .

Estimations of the average value of KD may be made by means of a regional approach, by applying Darcy's Law to the flow area:

$$KD = \frac{Q}{Ls} \quad (1)$$

The hydraulic gradient, s (dimensionless), is determined on the isohypses map. The discharge Q (cubic metres per day) over a length L (perpendicular to the flow) is measured or derived from a water balance.

Therefore, if Q is 2 m³/d over a length of 50 m, and $s = 2/1\ 000$, $KD = 20$ (square metres per day). If the layer has a thickness of 5 m, $K = 4$ (metres per day).

For drained fields, the KD values can be determined by field observations if the impervious layer is not deeper than 3–5 m from the rise in water level in between existing open drains and the water level in the drains and the estimate of outflow to the drainage system at the moment of measuring. Additional details on measurement of KD can be consulted in Annex 8. From the KD value and the measured K , it is possible to derive the D value. Where the thickness of the aquifer is greater, pumping tests in drilled wells are required, or regional methods can be applied (described above).

VERTICAL RESISTANCE

Another parameter, useful for estimating regional flow, is the vertical resistance (c). Many aquifers are covered by a less permeable (but not impermeable) layer. They are "semi-confined". In many river valleys, there is a clay layer on top of a thick sandy aquifer, the top layer formed in the Holocene, the lower one in the Pleistocene. Groundwater has to pass through the top layer twice: first, as downwards leakage; at the end, as upward seepage.

Such resistive layers are characterized by their thickness (D') and their vertical permeability (K_v), and c is their proportionality quotient for vertical flow contribution:

$$c = \frac{D'}{K_v} \quad (2)$$

For a clay with $K_v = 0.001$ m/d and $D' = 2$ m, the vertical resistance is $c = 2\ 000$ days. This value is expressed in days, as electrical resistance is in Ohms. A head difference of 1 m between bottom and top will cause upward seepage of 1/2 000 m/d or about 180 mm/year. If this groundwater contains diluted seawater, with 11 kg/m³ of salts, the annual salt load will be about 20 tonnes/ha. Even if the water seeping upward through the clay cap is less salty, it will cause heavy topsoil salinization in the long run, especially in arid and semi-arid regions.

CHARACTERISTIC LENGTH

The combination of transmissivity and resistance determines the properties of the system. Thus, the characteristic length (λ) is a measure for the extent of seepage zones and is roughly equal to their width. It is found from:

$$\lambda = \sqrt{Kdc} \quad (3)$$

where:

- c = vertical resistance of covering layer (d);
- d = “equivalent” thickness of aquifer (m);
- K = permeability of the aquifer (m/d);
- λ = characteristic length (m).

Values for c are found from pumping tests, estimated directly from experience or derived from the thickness D' and the (measured or estimated) vertical permeability K_v of the upper layer. Pumping tests are the most reliable method (and supply values for KD at the same time). Methods for pumping tests are described in the bibliographic references (Boonstra and De Ridder, 1994; Kruseman and De Ridder, 1994).

Models for such regional flow, such as SAHYSMOD (ILRI, 2005), are also available.

REFERENCES

- Boonstra, J. & De Ridder, N.A.** 1994. Single-well and aquifer tests. In H.P. Ritzema, ed. *Drainage principles and applications*, pp. 341–375. 2nd edition. ILRI Publication 16. Wageningen, The Netherlands, ILRI.
- Hooghoudt, S.B.** 1940. Algemeene beschouwing van het probleem van de detailontwatering en de infiltratie door middel van parallel loopende drains, greppels, slooten en kanalen. *Versl. Landbouwk. Onderz.*, 46(14).
- ILRI.** 2005. *SAHYSMOD, spatial agro-hydro-salinity model*. Version 1.7. Description of principles, user manual and case studies. SAHYSMOD working group of ILRI. Wageningen, The Netherlands. 134 pp.
- Kruseman, G.P. & De Ridder, N.A.** 1994. *Analysis and evaluation of pumping tests data*. ILRI Publication 47, 2nd. Wageningen, The Netherlands, ILRI. 377 pp.

Annex 6

Estimating recharge due to irrigation

DETERMINING DEEP PERCOLATION IN IRRIGATED FIELDS

Where drainage projects are planned and designed for irrigated lands, actual figures of deep percolation can be estimated from the water balance on the soil surface and in the rootzone. In dry periods when precipitation is negligible, the amount of deep percolation produced by an irrigation application is:

$$R = I_n - \Delta W = (I - E - S_r) - \Delta W \quad (1)$$

where:

E = evaporation losses (mm);

I = gross irrigation depth applied at the field level (mm);

I_n = amount of irrigation water infiltrated into the soil profile (mm);

S_r = amount of surface runoff (mm);

R = recharge (mm);

ΔW = change (increase [+] and decrease [-] of the moisture content of the rootzone (mm).

In Equation 1, the gross amount of water applied to a field, whose size is known, can be calculated if the flow is measured with a flume and the time of watering is determined with a watch. In a similar way, the amount of surface runoff can be measured. The value of ΔW can be estimated by determining the water content of soil samples taken before and after the irrigation application. The calculated value should be checked with the amount of water consumed by the crop (ET_c) in the previous period, which can be estimated by several methods (FAO, 1977 and 1998). Where relevant, precipitation should also be considered (FAO, 1974).

However, soil sampling is a tedious procedure that can be avoided by taking the period equal to an irrigation cycle. Just before irrigation, the soil has dried out; whereas just after irrigation, it is at field capacity. Thus, a period from before the first to before the second watering, or one from after the first until after the second, will have $\Delta W \approx 0$, and Equation 1 reads:

$$R = I_n - ET_c = (I - E - S_r) - ET_c \quad (2)$$

where:

ET_c = consumptive use during the irrigation cycle (mm).

Once ET_c in that period has been estimated and irrigation and runoff losses have been measured, R can be determined.

Example

Data from irrigation evaluations made in an pilot area of an irrigation scheme, situated in northeast Spain, show that on average 90 mm of water is applied by basin irrigation in the peak period, with an interval between two consecutive waterings of 12 days. Surface runoff is negligible (levelled field with small bunds) and direct evaporation losses during the irrigation application are about 3 mm. The consumptive use in the

peak period is about 66 mm ($ET_c \approx 5.5$ mm/d). Therefore, deep percolation is about 21 mm and the average value in the period considered is 1.75 mm/d.

PREDICTING DEEP PERCOLATION IN NEW IRRIGATION PROJECTS

Where the irrigation and drainage systems are designed jointly in new developments, the amount of expected percolation can be determined during the calculation of irrigation requirements from water retention data:

$$R = I(1 - e_a) - (E + S_r) \quad (3)$$

being:

$$I = \frac{\Delta W}{e_a} = \frac{1000Z_r(\theta_{fc} - \theta_i)}{e_a} \quad (4)$$

where:

$e_a = ET_c/I$ = application efficiency (0.00–1.00), which represents the ratio between the amount of water consumed by crops and the gross application depth;

Z_r = average thickness of the rootzone (m);

θ_{fc} = soil water retained at field capacity (m^3/m^3);

θ_i = minimum soil water fraction that allows for non-stress of the crop (m^3/m^3).

Where the θ_i value is unknown, the amount of water readily available to the crops can be estimated as approximately half the interval between field capacity and the permanent wilting point:

$$\theta_{fc} - \theta_i = \frac{1}{2}(\theta_{fc} - \theta_{wp}) \quad (5)$$

where:

θ_{wp} = soil water retained at wilting point (m^3/m^3).

For this calculation, an average value of e_a must be assumed (see below).

ESTIMATIONS WHERE NO FIELD DATA ARE AVAILABLE

In the planning phase, field data for the project area are usually scarce or non-existent. In these cases, tentative values for e_a and R can be used from literature.

In 1980, FAO provided information on water management from irrigated lands of arid zones (FAO, 1980). These guidelines considered only readily obtainable data, such as soil texture and irrigation method and some qualitative information on water management at the field level (Table A6.1).

TABLE A6.1
FAO guidelines to estimate the values of e_a and R

Irrigation method	Application practices	Soil texture			
		Fine	Coarse	Fine	Coarse
		e_a (%)		R (%I)	
Sprinkler	Daytime application; moderately strong wind	60	60	30	30
	Night application	70	70	25	25
Trickle		80	80	15	15
Basin	Poorly levelled and shaped	60	45	30	40
	Well levelled and shaped	75	60	20	30
Furrow & border	Poorly graded and sized	55	40	30	40
	Well graded and sized	65	50	25	35

Source: Adapted from FAO, 1980.

TABLE A6.2
Estimated values for deep percolation

Application method	Distribution uniformity	Water application efficiency		Estimated deep percolation
		Tanji & Hanson, 1990	SJVDIP, 1999	
(%)				
Sprinkler				
Periodic move	70–80	65–80	70–80	15–25
Continuous move	70–90	75–85	80–90	10–15
Solid set	90–95	85–90	70–80	5–10
Drip/trickle	80–90	75–90	80–90	5–20
Surface irrigation				
Furrow	80–90	60–90	70–85	5–25
Border	70–85	65–80	70–85	10–20
Basin	90–95	75–90		5–20

Note: Estimates for deep percolation were made on the basis of the following assumptions: no surface runoff under drip and sprinkler irrigation; daytime evaporation losses can be up to 10 percent sprinkling and 5 percent during night irrigation; tailwater in furrow and border irrigation can be up to 10 percent and evaporation losses up to 5 percent; no runoff is expected in basin irrigation and evaporation losses up to 5 percent (FAO, 2002).

Sources: Tanji and Hanson, 1990; SJVDIP, 1999.

In the past 20 years, considerable efforts have been made to improve irrigation application efficiencies in order to save water. Table A6.2 shows data from well-designed and well-managed irrigation systems in California, the United States of America, and potential maximum values for application efficiencies determined in irrigation evaluations in the San Joaquín Valley Drainage Implementation Program as mentioned in FAO (2002).

Tables A6.1 and A6.2 contain data from different types of systems and management. According to the expectations of a specific project area, the order of magnitude for a first approach to deep percolation can be estimated with the help of these tables. However, sensitivity analyses with various values should be performed in order to see the consequences in case the estimates are not correct. In addition, after the first parts of the irrigation system have been constructed, a direct verification in the field is recommended.

REFERENCES

- FAO. 1974. *Effective rainfall*, by N.G. Dastane. FAO Irrigation and Drainage Paper No. 25. Rome. 68 pp.
- FAO. 1977. *Crop water requirements*, by J. Doorenbos & W.O. Pruitt. FAO Irrigation and Drainage Paper No. 24, revised edition (reprinted 1992). Rome. 144 pp.
- FAO. 1980. *Drainage design factors*. FAO Irrigation and Drainage Paper No. 38. Rome. 52 pp.
- FAO. 1998. *Crop evapotranspiration – guidelines for computing crop water requirements*, by R.G. Allen, L.S. Pereira, D. Raes & M. Smith. FAO Irrigation and Drainage Paper No. 56. Rome. 300 pp.
- FAO. 2002. *Agricultural drainage water management in arid and semi-arid areas*, by K.K. Tanji & N.C. Kielen. FAO Irrigation and Drainage Paper No. 61. Rome. 188 pp.
- San Joaquin Valley Drainage Implementation Program (SJVDIP). 1999. *Source reduction technical committee report*. Sacramento, USA, Department of Water Resources 33 pp.
- Tanji, K.K. & B.R. Hanson. 1990. Drainage and return flows in relation to irrigation management. In B.A. Stewart & D.N. Nielsen, eds. *Irrigation of agricultural crops*. Agronomy Monograph No. 30. Madison, USA, American Society of Agronomy.

Annex 7

Leaching for salinity control

THE WATER AND SALT BALANCES

During rainfall, snowmelt or irrigation, part of the water is lost by runoff and evaporation, but a considerable part enters the soil and is stored there. This storage is partly taken up by plant roots, while any excess drains below the rootzone. On the other hand, in dry periods, the rootzone may receive water from deeper layers by capillary rise, especially where the water table is shallow and drainage poor. Monthly water balances are generally sufficiently revealing for water table control, while annual soil salinity balances usually provide enough information for soil salinity control.

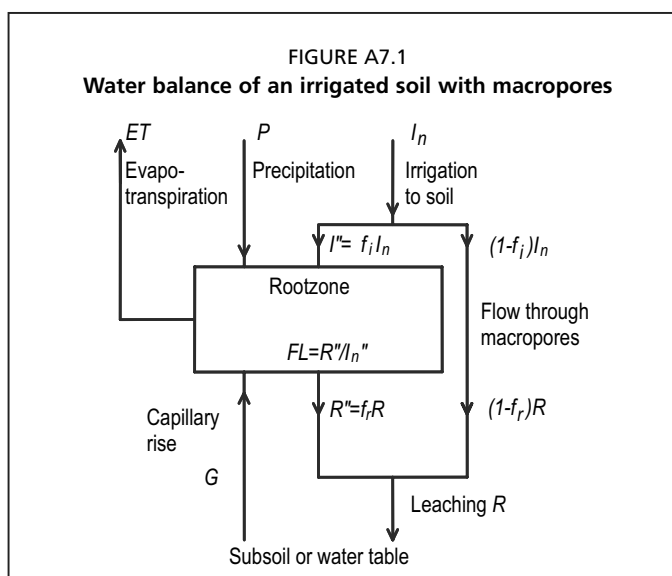

Coupled to this water balance, a balance can be made for soluble salts. They enter in tiny amounts through rain or snow, and in much larger quantities in irrigation water, even where this is considered as being of good quality. In the soil, these salts are concentrated by drying out, whereas plant roots take up water, but exclude the entry of salts. This increase in concentration should not be allowed to reach harmful levels for crop growth. This requires:

- adequate leaching: the inflow of water during a year must generate enough leaching to keep the salinity levels down;
- adequate natural or artificial drainage to allow removal of the leachate, and a safe depth of the water table to prevent harmful capillary rise of saline water;
- irrigation water of good quality, or, where poor, an extra amount to provide an increased leaching.

Therefore, a first estimate can be made by estimating the annual balances.

However, a complication is that not all water entering or leaving the soil is effective in leaching. Especially in many clay soils under surface irrigation (basin, furrow or border), part of the water passes downward through cracks and other macropores without contributing much to the removal of salts.

LEACHING FRACTION OF AN IRRIGATED FIELD

This is expressed by a leaching efficiency: the part of the water that is effective. There are two such coefficients: for the surface (fraction of the entering water, f_i); and at the bottom of the rootzone (fraction of the percolating water, f_r).

For irrigated lands, where water conservation and salinity control are required, it is necessary to compare the actual amounts of deep percolation produced by irrigation with the leaching required to ensure soil salinity control. The first step is to determine the actual value of the leaching fraction, which can be taken as a first approximation as:

$$LF = \frac{R}{I_n} \quad (1)$$

However, to allow for flow through macropores it is better defined as:

$$LF = \frac{f_r R}{f_i I_n} \quad (2)$$

This flow usually goes directly to the subsoil. In this case (Figure A7.1):

$$(1 - f_i)I_n = (1 - f_r)R \quad \text{or} \quad f_r = 1 - \frac{I_n}{R}(1 - f_i) \quad (3)$$

Therefore, one of the two coefficients is sufficient.

In these equations:

f_i = leaching efficiency coefficient as a fraction of the irrigation water applied;

f_r = leaching efficiency coefficient as a function of the percolation water;

I_n = net amount of irrigation water (amount infiltrating into soil) (mm);

LF = required leaching fraction;

R = amount of percolation water (mm).

As I is usually much larger than R , so f_i is considerably larger than f_r . The leaching efficiency coefficient f_r was defined by Boumans in Iraq (Dieleman, 1963), and later f_i was introduced by Van Hoorn in Tunisia (Van Hoorn and Van Alphen, 1994). In the literature, both values are used. The f_i coefficient is commonly used. This coefficient depends on soil texture and structure as well as on the irrigation method. It is higher (0.95–1.0) in well-structured loamy soils than in heavy clay cracking soils (< 0.85). It is also higher with sprinkler irrigation than with surface irrigation, and close to 1 under drip irrigation. Where needed, f_r can be found from Equation 3.

Therefore, the actual value of the LF depends on soil characteristics, the irrigation method and the specific water management practised by farmers.

Example

The data in the example in Annex 6 show that farmers apply a net irrigation of about 87 mm during the peak irrigation season, and that about 21 mm of this amount percolates below the rootzone. It was also determined that about 6 percent of the infiltrated water flows directly through cracks without mixing with the soil solution ($f_i \approx 0.94$ and $f_r \approx 0.75$). This means that during this irrigation cycle farmers are irrigating with an LF of about 0.2. Following a similar approach, the average LF during the irrigation season can be obtained where the total values of I_n and R are available.

LEACHING REQUIREMENTS IN TERMS OF A MINIMUM LF

In order to control soil salinity in irrigated lands, a minimum LF is required. This can be calculated where the value of the electrical conductivity of the irrigation water (EC_i) and the salt tolerance of the crop are known. One option is to apply the approach developed by Van Hoorn and Van Alphen (1994) based on the water and salt balances in equilibrium status. In this approach, it was considered that water extraction by crops decreases within the rootzone from 40 percent of the total in the top quarter to 10 percent in the deepest quarter (FAO, 1985). Following this approach, a relationship between the EC_i and the average soil salinity in the rootzone (expressed in terms of the electrical conductivity of the saturated paste [EC_e]) can be obtained for several values of the LF (Figure A7.2). Similar graphs can be obtained from water and salt balances derived considering other water extraction models adapted to specific local conditions, as crop root distribution is affected severely by soil properties and by irrigation water management.

By means of Figure A7.2, the minimum LF to control soil salinization (caused by the salts applied with irrigation water with certain EC_i) can be determined once the

threshold value of EC_e that must not be exceeded in the rootzone has been established from crop salt tolerance data. Data provided by Maas and Grattan (1999) about crop salt tolerance can be used (FAO, 2002).

Example

Following the example of the previous section, it is possible to calculate the minimum LF required to control the salt buildup caused by the salts applied with the irrigation water, whose salinity content in terms of EC_i is 0.6 dS/m. If maize is the most salt-sensitive crop of the cropping pattern, and its tolerance threshold in terms of EC_e is 1.7 dS/m, then a minimum LF of 0.05 is required to control soil salinity (Figure A7.2).

Assuming that the average LF during the irrigation season is 0.2 and the minimum LF is 0.05, it can be concluded that no salt buildup should be expected in the rootzone, and even the irrigation application efficiency might be increased while keeping soil salinity under control.

In irrigated lands, it is possible to check whether the actual value of the LF satisfies the minimum LF necessary to control soil salinity. Therefore, if the amount of percolation water is enough to cover the leaching requirements, water might be saved by improving the application efficiency. If not, the leaching requirements must be calculated.

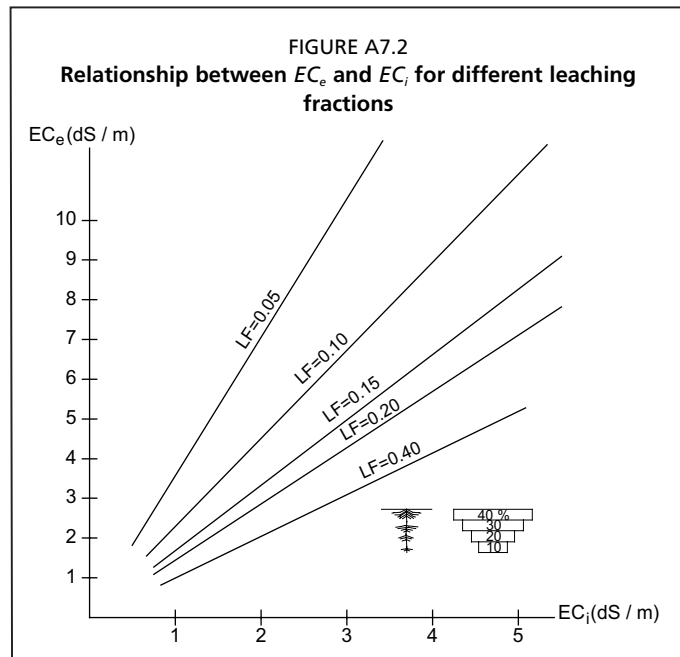

LEACHING REQUIREMENTS

Once the minimum LF is known, the long-term leaching requirements, for example, during the irrigation season, can be calculated by means of the salt equilibrium equation developed by Dieleman (1963) and later modified by Van Hoorn and Van Alphen (1994):

$$R^* = (ET_c - P_e) \frac{1 - f_i(1 - LF)}{f_i(1 - LF)} \quad (4)$$

where:

ET_c = actual crop evapotranspiration (mm);

P_e = effective precipitation (mm);

R^* = long-term leaching requirement (mm).

Therefore, the net irrigation requirement (I) is:

$$I = (ET_c - P_e) + R^* \quad (5)$$

Example

This example uses the case of the irrigated lands mentioned in the previous example (in which $f_i = 0.94$) and assumes that farmers need to irrigate with groundwater with an EC_i of 1.5 dS/m. If they still wish to grow maize in the soil of the previous example, they will need to irrigate with an LF of 0.3 (Figure A7.2). If the net irrigation requirement ($ET_c - P_e$) during the irrigation season is about 560 mm, at least 290 mm will be required to leach the salts accumulated in the rootzone. The net irrigation requirement will be

850 mm. If the actual LF is 0.2, about 185 mm of leaching can be obtained during the irrigation season (Equation 4). Therefore, the leaching deficit will be about 105 mm (290 - 185).

Where slightly soluble salts (e.g. gypsum, and magnesium and calcium carbonates) are present in the irrigation water, the leaching requirement is calculated first for the soluble salts. Then, the small contribution of the slightly soluble salts to the total soil salinity is added (Van der Molen, 1973). For average salt contents, the total solubility of gypsum and carbonates is about 40 meq/litre, which is equivalent to an EC of 3.3 dS/m. Where bicarbonates predominate in the irrigation water, it is advisable to decrease the sodium adsorption ratio (SAR) by increasing the calcium content of the soil solution by applying gypsum (5–20 tonnes/ha).

Once long-term soil salinity increases are no longer expected, a check should be made on the short term in order to be certain that the salt content of the soil solution does not exceed the threshold value of the crop salt tolerance. For this purpose, the salt storage equation derived for predicting the buildup of soil salinity on a weekly or monthly basis can be used (Van Hoorn and Van Alphen, 1994). The variation of salinity in the short term (Δz) can be calculated thus:

$$\Delta z = z_2 - z_1 = \frac{f_i I_n EC_i - f_r REC_1}{1 + \frac{f_r R}{2W_{fc}}} \quad (6)$$

where:

$$EC_1 = \frac{z_1}{W_{fc}} = \text{initial soil electric conductivity (deciSiemens per metre);}$$

$$W_{fc} = \text{moisture content at field capacity (mm);}$$

$$z_1 = \text{salt content in the rootzone at the start of the period (mm.dS/m);}$$

$$z_2 = \text{salt content in the rootzone at the end of the period (mm.dS/m).}$$

OPTIONS TO COVER THE LEACHING REQUIREMENTS

Where the actual value of the LF does not satisfy the minimum LF , options should be considered to cover the leaching deficit.

In monsoon and temperate regions, the salt content in the rootzone may increase during the irrigation season. However, excess rainfall after the irrigation period will supply enough percolation water to leach out the salts accumulated in the rootzone. In this way, the salt content at the beginning of the next irrigation season will be sufficiently low to prevent secondary salinization.

Example

In the case described in the previous example, 100 mm of excess rainfall in winter might provide the percolation required to cover the leaching deficit. Therefore, even when irrigating with water with an EC_i of 1.5 dS/m, the soil salinity might be controlled on an annual basis under actual irrigation management.

However, where no effective precipitation is available for leaching, as is usually the case in arid and semi-arid zones, the leaching deficit must be covered by increasing the annual allocation of irrigation water. To cover uniformity deficiencies in water distribution over the irrigated field, the amount of percolation water should exceed the leaching requirements:

$$I = (ET_c - P_e) + aR^* \quad (7)$$

The a coefficient may vary from 1.15 to 1.20 if irrigation uniformity is fairly appropriate.

If, under the current irrigation management, the leaching requirements are not satisfied ($R \leq aR^*$), there are two options: grow crops that are more tolerant of salinity and in this way reduce the minimum LF ; or find out how to cover the leaching deficit. In the latter case there are two possibilities: remove the accumulated salts before sowing the next crop by applying irrigation water; or split up the leaching requirement during the irrigation period by increasing each irrigation application.

EFFECTS OF LEACHING FOR SALINITY CONTROL ON SUBSURFACE DRAINAGE DESIGN

Where the leaching requirements are covered by the actual irrigation management or after the cropping season by rainfall or out-of season leaching irrigation, salinity control does not affect the drainage coefficient used for subsurface drainage design. However, if more water has to be added with each application in order to increase the LF , salinity control affects subsurface drainage design because the drainage coefficient must also be increased.

The option of increasing the irrigation allocation depends on the availability of water resources during or at the end of the growing season. It also depends on the internal drainage capacity of the soils. Coarse-textured soils permit leaching fractions of 0.15–0.25, while in fine-textured soils with low permeability the LF should be lower than 0.10 because of their limited internal drainage (unless rice is grown). In addition, the environmental effect of increasing the volume of drainage water on drainage disposal should be considered. Thus, growing more salt-tolerant crops is frequently a better option than using more water and increasing field and disposal drainage needs.

Controlling soil salinity caused by capillary rise generally does not increase the drainage coefficient. This is because it is dependent on adopting a suitable depth of the groundwater table and maintaining a downward flow of water during the irrigation season. Where leaching is required in order to remove the accumulated salts in the rootzone, water is generally applied before the start of the cropping season.

REFERENCES

- Dieleman, P., ed. 1963. *Reclamation of salt affected soils in Iraq*. ILRI Publication 11. Wageningen, The Netherlands. 174 pp.
- FAO. 1985. *Water quality for agriculture*, by R.S. Ayers & D.W. Westcot. FAO Irrigation and Drainage Paper No. 29 Rev. 1. Rome. 174 pp.
- FAO. 2002. *Agricultural drainage water management in arid and semi-arid areas*, by K.K. Tanji & N.C. Kielen. FAO Irrigation and Drainage Paper No. 61. Rome. 188 pp.
- Maas, E.V. & Grattan, S.R. 1999. Crop yields as affected by salinity. In R.W. Skaggs & J. Van Schilfgaarde, eds. *Agricultural drainage*. Agronomy Series 38. Madison, USA.
- Van der Molen, W.H. 1973. Salt balance and leaching requirement. In: *Drainage principles and applications*, pp. 59–100. ILRI Publication 16, Vol. 2. Wageningen, The Netherlands, ILRI.
- Van Hoorn, J.W. & Van Alphen, J.G. 1994. Salinity control. In H.P. Ritzema, ed. *Drainage principles and applications*, pp. 533–600. 2nd edition. ILRI Publication 16. Wageningen, The Netherlands, ILRI.

Annex 8

Procedures for determining soil hydrological characteristics in drained lands

PROCEDURE FOR DETERMINING HYDRAULIC CONDUCTIVITY

Steady-state flow

Where water flows toward the drains under steady-state conditions, an average value of the hydraulic conductivity can be obtained from:

$$K = \frac{qL^2}{8h_b D} \quad (1)$$

where:

- B = drain length (m);
- D = average thickness of the horizontal flow region (m);
- h_b = hydraulic head for horizontal flow (m);
- K = hydraulic conductivity (m/d);
- L = drain spacing (m);
- Q = outflow (m³/d);

$$q = \frac{Q}{LB} = \text{specific discharge (m/d)}.$$

In Equation 1, L is a design parameter that is known; q is calculated from the value of Q measured at the drain outlet; h_b is measured by difference in piezometer readings in tubes laid midway between two drains (h_1) and at some distance from the drain (h_2), outside the zone where radial flow is important, as shown in Figure A8.1. The radial flow in the vicinity of the drain has been excluded from the measurements.

For shallow aquifers ($D < L/4$), D approaches the real thickness of the permeable layer. However, for deeper ones, the maximum value for D is $L/3$. Where the D value has been determined by augering, an average value of K can be calculated with Equation 1.

Table A8.1 shows an example of the calculation of KD values from groundwater-level observations in piezometers laid midway between two drains (z_{25}) and in the vicinity of the drain ($z_{6,5}$), for drains laid at 50-m spacings and 1.8 m deep in a pilot field of peat soils with a sandy substratum severely recharged by seepage.

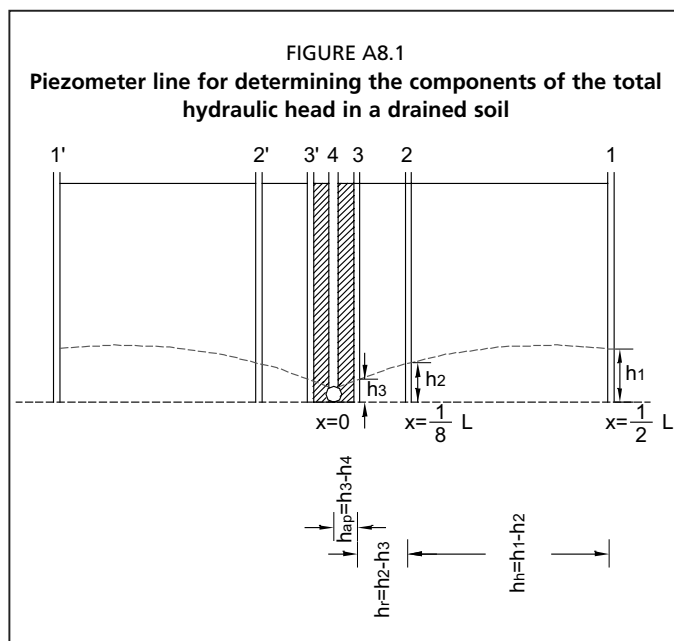
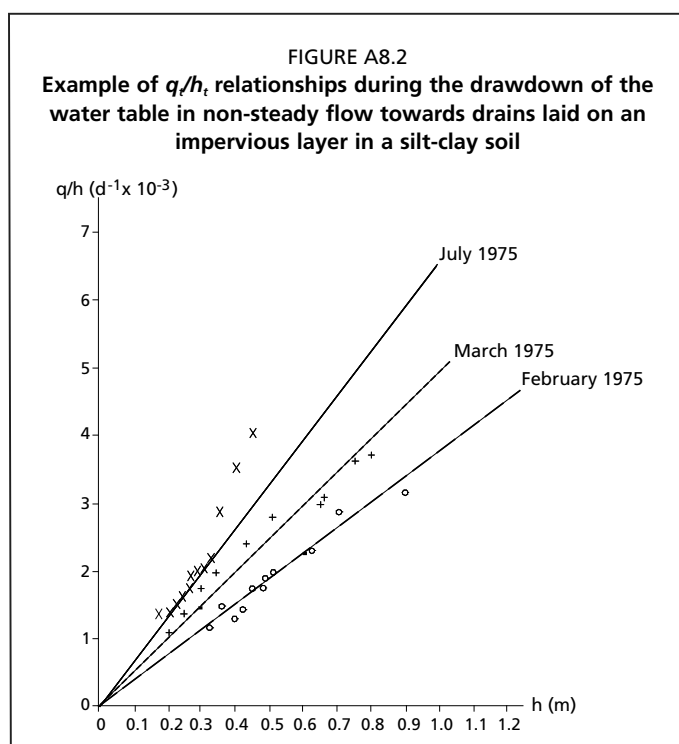

TABLE A8.1

Determination of KD values from groundwater-level observations in a drained soil with a sandy substratum

Drain no.	Period of observations (1984)	z_{25} (m)	$z_{12.5}$ (m)	$z_{6.5}$ (m)	$h_1 = 1.8 - z_{25}$ (m)	$h_2 = 1.8 - z_{6.5}$ (m)	h_h (m)	q (mm/d)	KD (m ² /d)
13	January–March	0.95	0.97	1.07	0.85	0.73	0.12	22.3	58.1
	April–June	1.03	1.04	1.14	0.77	0.66	0.11	19.5	55.4
	July–October	1.08	1.09	1.17	0.72	0.63	0.09	17.0	59.0
14	January– March	0.86	0.89	0.97	0.94	0.83	0.11	22.6	64.2
	April–June	0.95	0.97	1.05	0.85	0.75	0.10	18.0	56.3
16	January– March	0.52	0.56	0.62	1.28	1.18	0.10	21.1	65.9
	April–May	0.57	0.60	0.66	1.23	1.14	0.09	18.0	62.5



Source: Adapted from Martínez Beltrán, 1978.

The average KD value calculated from observations made in three drains over ten months was 60 m²/d. If the sandy layer in which the drains are laid has an average thickness of about 8 m, the average value for the hydraulic conductivity of the sandy layer is 7.5 m/d.

Non-steady-state flow

In drained lands where laterals are laid on the impervious layer, water flow is generally non-steady, especially after an irrigation application or heavy rainfall. However, the average value of the hydraulic conductivity of the permeable layer can be calculated from observations of the drawdown of the water table, where the phreatic level has an elliptic shape. Under these conditions, the Boussinesq equation for the specific discharge reads:

$$q_t = \frac{3.46K}{L^2} h_t^2 \quad (2)$$

where:

q_t = specific discharge at time t (m/d);

h_t = hydraulic head midway between drains at time t (m).

Therefore, if the function $q_t/h_t = f(h_t)$ is represented graphically, with data from observations made during several drainage periods, straight lines can be obtained, as those represented as an example in Figure A8.2.

The slope of the $q_t/h_t = f(h_t)$ function is equal to:

$$tg\gamma = \frac{3.46K}{L^2} \quad (3)$$

From Equation 3, K values can be obtained, as shown in Table A8.2.

TABLE A8.2
Calculation of hydraulic conductivity with the Boussinesq equation

Period of observations	Drawdown of the groundwater level (m)	Correlation coefficient $q_i/h_i = f(h_i)$	$tg\gamma 10^{-3}$	K (m/d)
February 1976	0.30–1.10	0.96	4.05	0.47
July–August 1976	0.10–1.10	0.91	8.67	1.00
January–February 1977	0.60–1.10	0.97	3.81	0.44
June–July 1977	0.50–1.00	0.94	4.80	0.55

Source: Martínez Beltrán, 1978.

Results from Table A8.2 show K values of about 0.5 m/d where the groundwater level is below the top layer (0–30 cm). A higher value of 1 m/d was obtained when the water level was close to the ground surface. However, in this case, the correlation coefficient was lower than in the previous cases (probably because of an almost flat shape of the water table and because of the high hydraulic conductivity of the top layer).

DETERMINING RADIAL RESISTANCE

Resistance to steady-state radial flow towards drains installed above the impervious layer can also be determined from observations in drained lands:

$$W_r = \frac{h_r}{qL} \quad (4)$$

where:

h_r = hydraulic head for radial flow (m);

W_r = radial resistance (d/m).

In Equation 4, h_r is measured by the difference in piezometer readings in tubes laid at some distance from the drain (h_2) and close to the drain trench (h_3), as shown in Figure A8.1.

Table A8.3 shows an example of calculation of W_r values from water-level observations in piezometers laid in the vicinity of the drain ($z_{6.5}$) and close to the drain (z_0), for drains laid at 50-m spacings and 1.8 m deep in a sand layer.

Results from three drains observed during different periods show an average radial resistance of 0.24 d/m.

PROCEDURE FOR DETERMINING THE DRAINABLE PORE SPACE

For drained lands, the μ value of the layer above drain level can be measured from the drawdown of the water table (determined by piezometer recording) and the amount of water drained in the period considered (calculated from measurements of the drain discharge). The restrictions are that evaporation and seepage to or from deeper layers must be low and can be ignored relative to the drain discharge.

TABLE A8.3
Determination of W_r from observations in a drained soil with a sandy substratum

Drain no.	Period of observations (1984)	$z_{6.5}$	z_0	$h_2 = 1.8 - z_{6.5}$	$h_3 = 1.8 - z_0$	h_r	q	W_r
		(m)	(m)	(m)	(m)	(m)	(mm/d)	(d/m)
13	January–March	1.07	1.38	0.73	0.42	0.31	22.3	0.28
	April–June	1.14	1.38	0.66	0.42	0.24	19.5	0.25
	July–October	1.17	1.33	0.63	0.47	0.16	17.0	0.19
14	January– March	0.97	1.26	0.83	0.54	0.29	22.6	0.26
	April–June	1.05	1.26	0.75	0.54	0.21	18.0	0.23
16	January– March	0.62	0.87	1.18	0.93	0.25	21.1	0.24
	April–May	0.66	0.87	1.14	0.93	0.21	18.0	0.23

TABLE A8.4
Calculation of the μ value from the water balance in drained lands

Period of observations	Drawdown of the water level	D_r	Δh	μ	$\bar{\mu}$
	(m)	(mm)	(mm)	(%)	(%)
January 1975	0.55–0.80	11.2	219	5.1	4.3
	0.80–0.95	5.3	156	3.4	
	0.95–1.10	4.7	125	3.8	
February 1976	0.95–1.10	4.8	97	4.9	4.7
	1.10–1.20	2.1	46	4.6	
January 1977	0.75–1.10	7.1	169	4.2	3.9
	0.85–1.20	10.2	288	3.5	

Source: Martínez Beltrán, 1978.

Therefore, if the recharge to the water table and natural drainage are negligible and there is no depletion of the water table from plant roots in the time interval selected, the drainable pore space can be found from:

$$\mu = \frac{D_r}{\Delta h} \quad (5)$$

where:

D_r = amount of drainage water converted to an equivalent surface depth (mm);

μ = drainable pore space;

Δh = average drawdown of the water table in the time considered (mm).

D_r and Δh must be expressed in the same units.

To determine the average μ value, it is only necessary to measure, during the interval of time selected, the average drawdown of the water table from piezometer readings and the amount of water drained in the same period. The drainable pore space is a dimensionless fraction, often expressed as a percentage, as in Table A8.4. Table A8.4 shows an example calculation of the average μ value of a silty-clay soil, with data from observations made during three consecutive winters.

The results of this table show the tendency of μ to decrease with soil depth. For example, the 1975 observations show a value of 5.1 percent for a soil layer with a prismatic structure and about 3.9 for the deeper, less-structured soil layer. However, for drain spacing calculations an average value of 4.3 percent can be considered. The average value calculated with the results of the following years was of the same magnitude.

REFERENCES

Martínez Beltrán, J. 1978. *Drainage and reclamation of salt affected soils in the Bardenas area, Spain*. ILRI Publication 24. Wageningen, The Netherlands, ILRI. 321 pp.

Annex 9

Procedure for deriving drainage design criteria from drained lands

SUBSURFACE DRAINAGE COEFFICIENTS

From observations of the groundwater level and measurements of drain discharge, hydrographs such as those in Figure A9.1 can be drawn.

This example (from a flat coastal area in eastern Spain) shows that during dry periods (from mid-June to late September), in the absence of irrigation, the subsurface drainage flow towards the observed drain was steady, with a drain discharge of about 17 mm/d, due to seepage. However, in winter and spring, the drainage system was also recharged by percolation of rainfall, and then the water flow was non-steady.

With this information, sound drainage criteria can be formulated for steady-state flow drainage design. If in addition to seepage, during the irrigation season, there is a recharge of about 1 mm/d from irrigation losses, a drainage coefficient of 18 mm/d will be required in order to control the water table during the dry period. However, if after heavy rainfall, high water tables are affecting winter crops or hampering soil trafficability, the drain spacing calculated for steady flow should be checked for non-steady conditions.

In irrigated lands without such high seepage, water flow towards drains is generally non-steady, as Figure A9.2 shows. Information from drainage periods such as those shown in Figure A9.2 is useful for determining the magnitude of the rise of the water table after irrigation and further drawdown during the interval between two consecutive irrigation applications.

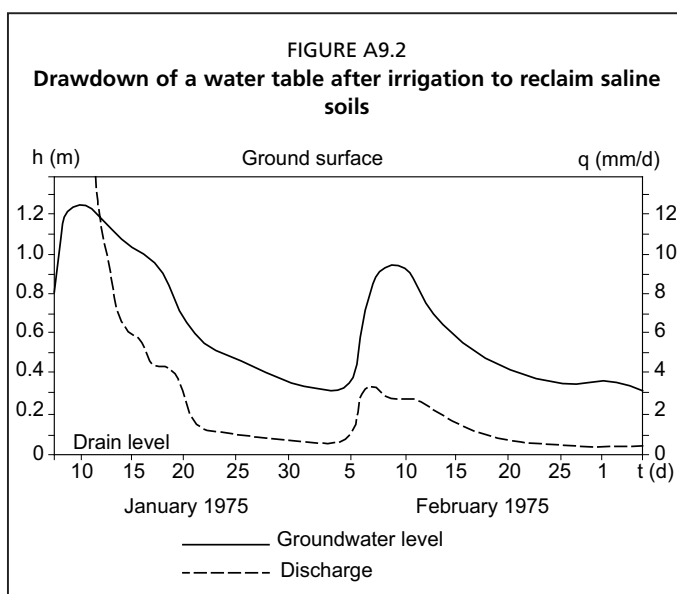
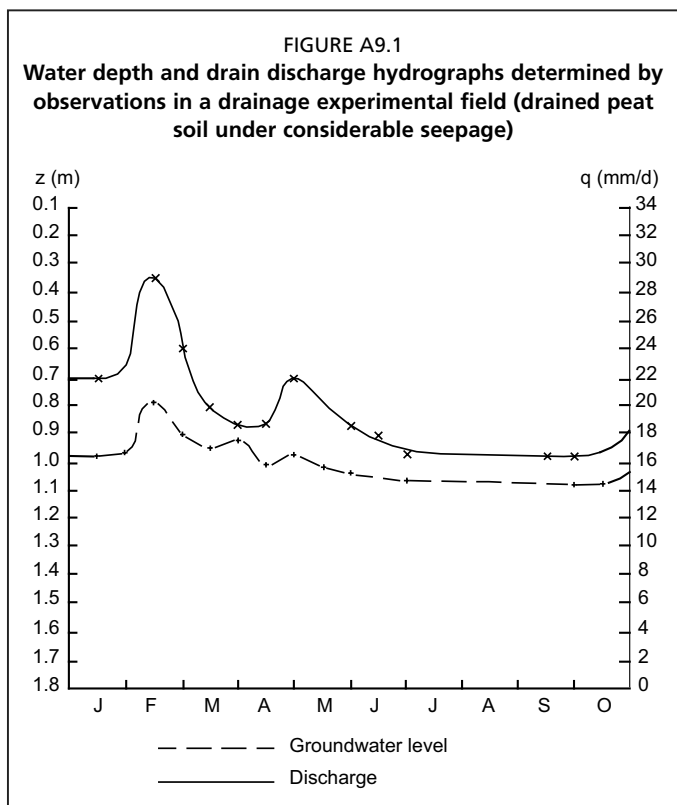

Source: Adapted from Martínez Beltrán, 1978.

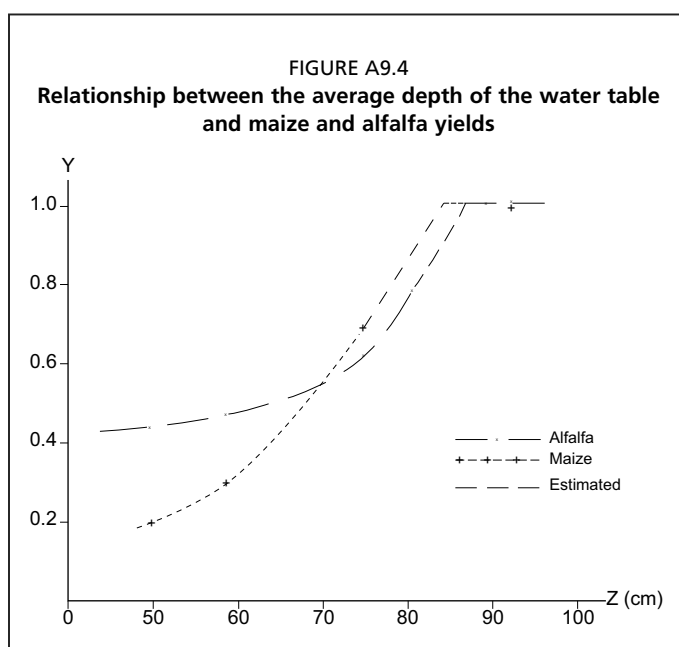
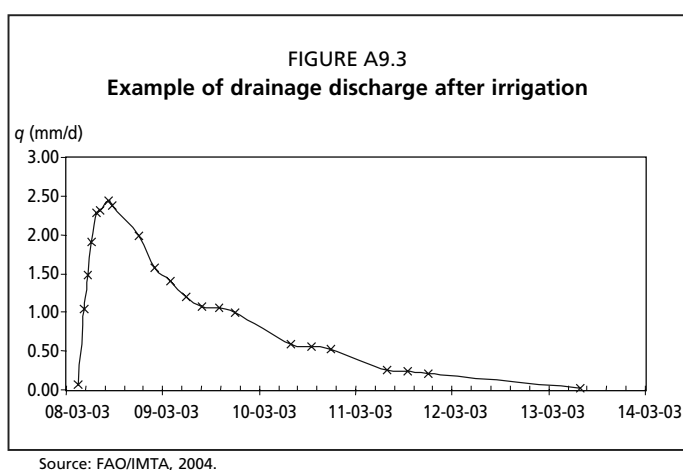

considered (Sieben, 1964). In this case, the SDW_{50} (sum of days with less than 50 cm depth) is also a good measure for crop damage. In the Dutch polders, SDW_{30} (less than 30 cm depth) is usually taken for field crops.

However, for irrigated lands, the actual non-steady drainage criteria can be translated into more or less equivalent steady-state drainage criteria. For example, the hydrograph in Figure A9.3 shows that after an irrigation application, discharge decreases from a maximum value of about 2.5 mm/d to zero (just before the next irrigation). However, the average discharge during the drainage period was about 1 mm/d. Therefore, this latter discharge can be used as the drainage coefficient for drain spacing calculations using steady-state equations.

DESIGN DEPTH TO THE HIGHEST WATER TABLE

The relationship between the average depth to the water table and crop yields and trafficability or the duration and intensity with which groundwater levels exceed a crop-specific critical depth during the growing season can also be estimated from observations in drained lands.

Table A9.1 shows groundwater depth data from four plots with different drainage conditions and their impact on yields of irrigated maize and alfalfa.

Table A9.1 also includes the SDW value, as used in the Dutch polders. It is the sum of days with waterlogging during the period

TABLE A9.1
Maize and alfalfa yields compared with data of the groundwater table

Period (1977)	Consecutive days in which the groundwater level was above the depth indicated (cm)															
	25	50	75	100	25	50	75	100	25	50	75	100	25	50	75	100
June	4	5	6	20	5	6	10	30	5	9	22	30	5	20	30	30
July	2	3	4	10	2	3	10	31	1	10	25	31	1	19	31	31
August	2	4	5	16	3	6	10	31	2	14	28	31	3	24	30	31
September	2	4	5	7	3	4	8	23	3	8	17	30	3	8	14	30
SDW_{50}	16				19				41				71			
Alfalfa yield (kg/ha) and relative yield	12 195				7 600				5 780				5 415			
	1.00				0.62				0.47				0.44			
Maize yield (kg/ha) and relative yield	5 800				4 000				1 730				1 180			
	1.00				0.69				0.30				0.20			

Source: Adapted from Martínez Beltrán, 1978.

Although under irrigation the water level varies with time, the average depth of the water table is a good indicator concerning crop yields. Figure A9.4 shows the relationship between the relative crop yield (Y) and the average depth of the water table (\bar{z}) during the irrigation season, as per the data in Table A9.1.

Although data from only one irrigation season are not sufficient to obtain a statistically sound relationship, these results are useful for providing practical guidance to be confirmed later with further information. It seems that an average depth of 85 cm is critical for maize and alfalfa, which were the most relevant irrigated crops in the study area. In this case, the groundwater depth criterion is dominant because no long dry fallow periods or periods with frequent shortages of irrigation water occur. Where this is not the case, especially where the groundwater is rather salty, deeper groundwater levels during such extended dry periods are required in order to avert soil salinization by capillary rise.

The data in Table A9.1 also show that short periods of high water tables are not harmful for the above-mentioned crops.

In the Dutch polders, with a humid climate, no appreciable damage to crops was found where during heavy rains in winter the groundwater did not rise above 0.30 m depth below the surface, provided that it receded within a few days. Higher groundwater levels led to slaking of the ploughed layer, causing more permanent anaerobic conditions and damage to field crops. These silty-clay soils needed a drainage depth of 1.20 m in order to keep the average levels low enough.

REFERENCES

- FAO/IMTA. 2004. Evaluación de sistemas de drenaje en el Distrito de Riego 041, Río Yaqui, Son., y en el Distrito de Riego 076, Valle del Carrizo, Sin., México.
- Martínez Beltrán, J. 1978. *Drainage and reclamation of salt affected soils in the Bardenas area, Spain*. ILRI Publication 24. Wageningen, The Netherlands, ILRI. 321 pp.
- Sieben, W.H. 1964. De invloed vande ontwateringstoestand op stikstofhuishouding en opbrengst. *Landbouwkundig Tijds.*, 76: 784–802.

Annex 10

Calculations regarding elements of the main drainage system

OPEN CHANNELS AND THEIR CROSS-SECTIONS

For open channels, Manning's formula is widely used:

$$v = K_m R^{2/3} s^{1/2} = \frac{1}{n} R^{2/3} s^{1/2} \quad (1)$$

being:

$$R = A / u ;$$

$$A = by + \alpha y^2 ;$$

$$u = b + 2y\sqrt{1 + \alpha^2} ;$$

$v = Q / A$: average flow velocity over the cross-section A ;

where (see Figure A10.1):

A = cross-sectional area of flow (m^2);

b = bottom width (m);

$K_m = 1/n$ = roughness coefficient ($m^{1/3}/s$);

$n = 1/K_m$ roughness coefficient ($s/m^{1/3}$);

Q = discharge (m^3/s);

R = hydraulic radius (m);

s = hydraulic gradient (-);

u = wetted perimeter (m);

v = average flow velocity (m/s);

y = water depth (m);

α = coefficient in side slope ($v:h$) 1: α .

The roughness coefficient K_m depends on factors such as the irregularities of the drain bed and side slopes, amount of vegetation, irregular alignment and hydraulic radius of the open drain. Values range from 50 for large channels in bare earth, to 20 for open drains two-thirds choked with vegetation, to less than 10 for entirely choked ones. Table A10.1 lists design values for normally maintained channels. For the coefficient K_m , the following equations for such open waterways (with some vegetation) are used, in which it is supposed that the channels have been cleaned before the onset of the wet season (so that they are in a reasonable condition).

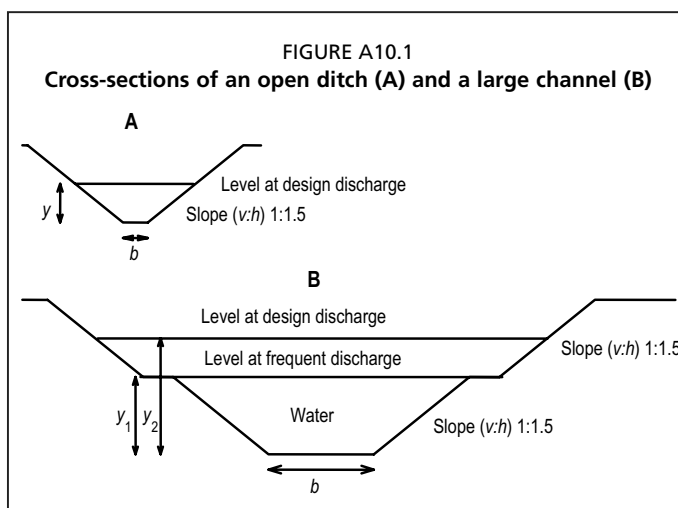

TABLE A10.1

Design parameters for open drains

Drain size	Water depth y (m)	Ratio $b:y$	Soil texture	Manning's K_m ($m^{1/3}s^{-1}$)	n
Small	< 0.75	1–2	sandy	20	0.050
			clayey	15	0.067
Medium	0.75–1.5	2–3	sandy	30	0.033
			clayey	20	0.050
Large	> 1.5	3–4		40–50	0.020–0.025

Sources: Adapted from ILRI, 1964; and from Smedema, Vlotman and Rycroft, 2004.

TABLE A10.2

Maximum average water velocity and bank slopes for open ditches

Soil type	v_M (m/s)	Bank $v:h$
Heavy clay	0.60–0.80	1:0.75 to 1:2
Loam	0.30–0.60	1:1.5 to 1:2.5
Fine sand	0.15–0.30	1:2 to 1:3
Coarse sand	0.20–0.50	1:1.5 to 1:3
Tight peat	0.30–0.60	1:1 to 1:2
Loose peat	0.15–0.30	1:2 to 1:4

Source: Adapted from ILRI, 1964.

larger discharge. At 1.5–2 times design discharge, some inundation may be allowed to occur in low places, but disasters and extensive inundation should not occur.

Depth and freeboard

The depth of a drainage channel equals:

$$Z_c = F + y \quad (3)$$

where:

F = freeboard (m);

y = water depth (m);

Z_c = collector depth below soil surface (m).

The freeboard F must be such that at design discharge the outlets of any subsurface drains, including pipe collectors, are just above or equal to the drainage-channel water level, although a slightly higher water level can be tolerated temporarily. This usually leads to water levels of 1–2 m below the land surface at design discharge. In arid regions, drain outlets should remain above the water level, although they may become temporarily submerged after an infrequent rainfall has caused large surface runoff volumes to the open drain.

Wind effects

Similar to shallow seas, long canals (> 10 km) may be subject to storm surges when strong winds blow in the direction of the waterway. However, in most situations, such wind effects are negligible.

An estimate for storm surges at sea, but also for all kinds of waterways, is:

$$\frac{dh}{dx} = \Phi \frac{v^2}{gv} \quad \text{or} \quad \Delta h = \Psi \frac{v^2}{y} B \quad (4)$$

where:

B = length of waterway, in wind direction (km);

v = wind velocity (m/s);

$$\text{If } y < 1 \text{ then } K_m = 32y^{0.84} - 2.0 \quad (2a)$$

$$\text{else } K_m = 30y^{0.125} \quad (2b)$$

The ratio of bottom width (b) to water depth (y) should remain preferably within certain limits (Table A10.1). Where this ratio is known, the required cross-section can be calculated with the above formulae.

The average flow velocity v over the cross-section should not be so high that erosion of the bottom or banks occurs. Table A10.2 gives some values for the maximum average flow velocities and also the recommended side slopes for trapezoidal cross-sections.

For safety, it is advisable to check the behaviour of the system at a

- g = acceleration of gravity (m/s^2);
 b = head (m);
 x = distance (m);
 y = water depth (m);
 Δb = head difference along canal, caused by wind (m);
 $\Phi \cong 4.10^{-6}$ = coefficient;
 $\Psi \cong 0.0004$ = coefficient.

For seas and estuaries, the calculation must be numerical, using sections of the same, or almost the same, depth.

Normal flow and inundation

Where the water level downstream is lower than the upstream water level of an outflow, channel flow occurs. Depending on the conditions, this channel flow may be streaming or shooting. This is governed by the Froude–Boussinesq number:

$$Fr = \frac{v}{\sqrt{gy}} \quad (5)$$

where:

- Fr = Froude–Boussinesq number;
 g = 9.81 = acceleration gravity (m/s^2);
 y = water depth (m);
 v = flow velocity (m/s).

For streaming water, it is required that $Fr < 1$; while for $Fr > 1$, shooting occurs.

Streaming water is supposed to obey Manning's formula (Equation 1).

If the water level downstream becomes higher than the land surface, overflow and inundation occur.

Backwater effects

Backwater curves occur near the downstream end of a channel, where it joins other watercourses with a higher water level or within the reach with a backwater curve effect upstream of weirs. Upstream, the water will reach a constant equilibrium depth in accordance with a given flow. However, near the downstream end, the water level will come under the influence of the fixed downstream level and form a curve upwards or downwards (Figure A10.2) depending on whether this level is higher or lower than the water level corresponding with the upstream equilibrium depth. Complications arise when the land is inundated or when the channel overflows.

The program BACKWAT is based on these considerations. This program calculates the equilibrium depth by iteration. The calculations start at the downstream end, where the water level is given. They are numerical, with steps in water depth of a given size. The water depth diminishes inland if the curve is convex, and increases inland if concave (Figure A10.2). In the latter case, overflow may occur upstream.

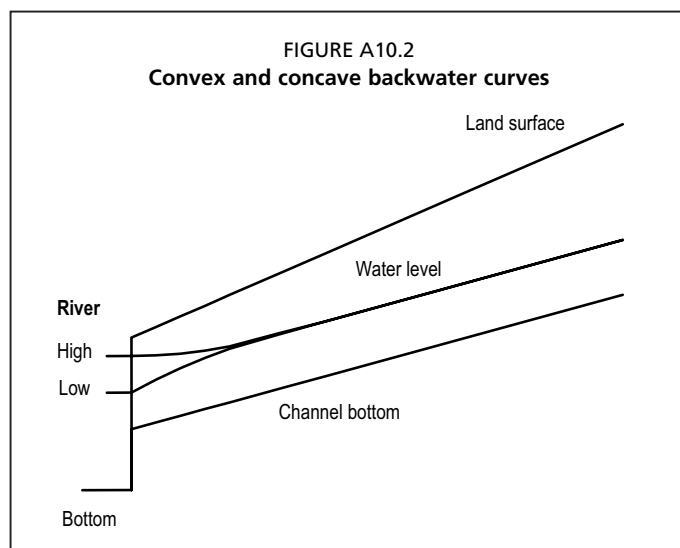

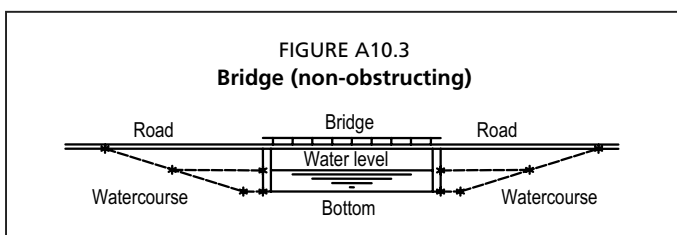

If shooting occurs, the program terminates.

CULVERTS AND BRIDGES

For culverts, there are two types of head losses, caused by:

- convergence of streamlines at the entrance – these losses are not recovered at the exit;

- friction losses, occurring at the walls of culverts.

For the former, laws for flow through openings apply. The hydraulic section of a culvert can be calculated using:

$$Q = \mu A \sqrt{2g\Delta h} \quad (6)$$

where:

A = area of the hydraulic section (m^2);

g = 9.8 m/s^2 is the gravity acceleration;

Q = design discharge (m^3/s), preferably increased by a safety factor;

μ = coefficient that depends on the shape of the entrance and at the exit;

Δh = head loss along the culvert (m).

The design discharge is often taken some 25–50 percent higher than for the upstream drainage channel. This is because the flexibility of culverts to accommodate for higher flows without causing structural damage is less than for open waterways. The values of μ are about 0.7 for long culverts (20–30 m) and 0.8 for short culverts (< 10 m) (ILRI, 1964). Head losses of 5 cm for small structures and 10 cm for large ones are generally taken (Smedema, Vlotman and Rycroft, 2004). In order to calculate the cross-section of the structure, in addition to the wet section A , a minimum of 10 cm of clearance should be added.

The friction losses in culverts are of minor importance for the usual short passages under rural roads. For longer culverts, the head losses for friction must be added. Manning's formula is often used, with a K_m of 60–70 for smooth and 30–40 for corrugated walls.

Bridges are often constructed in such a way that the watercourse passes freely underneath, in which case they have no influence (Figure A10.3). If the channel is narrowed by the bridge, Equation 6 may be used, with $\mu = 0.8$ – 0.9 (Smedema, Vlotman and Rycroft, 2004). Friction losses can be ignored as the influence of the short length of the narrow passage is small.

WEIRS AND DROP STRUCTURES

The width of freely discharging rectangular weirs and drop structures is calculated with the formula:

$$Q = \frac{2}{3} \mu b h \sqrt{\frac{2}{3} gh} = 1.7 \mu b h^{3/2} \quad (7)$$

where:

b = crest width (m);

g = 9.8 m/s^2 is the gravity acceleration;

h = head above the crest level (m);

Q = discharge (m^3/s);

μ = contraction coefficient.

For submerged discharge the following equation may be used:

$$Q = \mu b h_2 \sqrt{2g(h_1 - h_2)} \quad (8)$$

where:

h_1 = upstream water head (m);

h_2 = downstream head (m);

$\Delta h = h_1 - h_2$ = available head (m).

The values of the coefficients in Equation 7 and 8 are mostly determined by the width/shape of the weir crest (broad or sharp, as shown in Figure A10.4) and by the nature of the approach flow (degree of streamline contraction and entry turbulence). For similar weirs, the μ values are in principle the same

for both equations. Values for semi-sharp crested weirs commonly used in drainage channels (e.g. stop-log weirs) are generally in the order of 1.0–1.1 (Smedema, Vlotman and Rycroft, 2004). For sharp-crested weirs, the higher values of μ should be used.

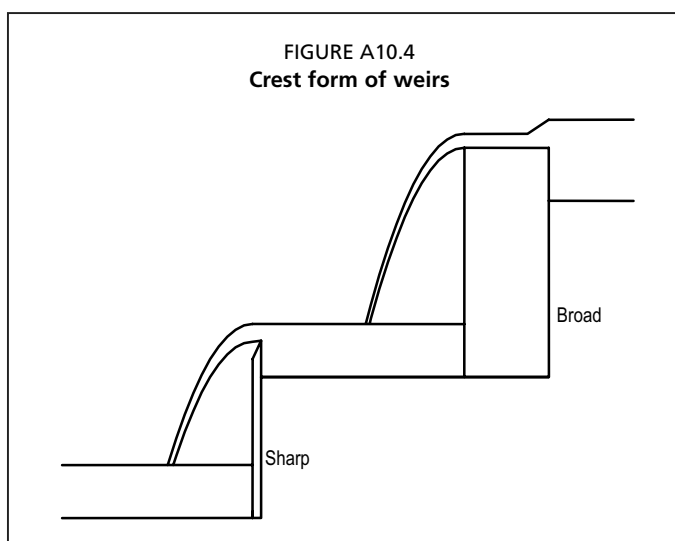

OUTLET STRUCTURES

Sluices and flap gates

The discharge rate through a sluice or flap gate can be calculated with Equation 6, being in this case b the width of the sluice and μ a coefficient from 0.9 to 1.1. The water depth h_2 should be increased by 3.5 percent if the sluice discharges directly into the sea, because of the heavier saltwater outside (Smedema, Vlotman and Rycroft, 2004). The outside water heights vary with tides or floods, so that at high levels discharge is not possible and water must be stored inside. Therefore, the calculations must be numerical, in time steps, for water level and storage conditions that are typical for the location involved.

Pumping stations

The capacity of a pumping station is determined by the total discharge from all sources: rainfall, irrigation excess, seepage, municipal and industrial wastewaters, etc. However, it is not simple to estimate the simultaneous occurrence of all these events. In contrast to open watercourses, pumps have a rather inflexible capacity, so that some reserve is usually added.

A pumping station often has to run at full capacity for short periods only. Most of the time it has to remove the “base flow” from more permanent sources, of which seepage and tail-end losses from irrigation systems are the main ones. More than the strongly variable inputs from rainfall, these flows determine the number of pumping hours per year and, consequently, the costs of operation.

In order to cope with the variable capacity needed in different periods, more than one pump is usually installed, of which one to remove the base flow and one or more to cope with larger discharges and the design discharge at critical periods.

In order to select the most appropriate capacity arrangement and type of pump, some design parameters should be calculated, namely: the base, usual and maximum discharge, the lift and the dynamic head, and the power requirement.

The lift equals the static difference between inside and outside water. The dynamic head may be calculated using:

$$b = h_s + \Delta b + \frac{v_d^2}{2g} \quad (9)$$

where:

$g \approx 9.8 \text{ m/s}^2$;

b = total head (m);

h_s = lift or static head (m);

v_d = flow velocity at the outlet of the delivery pipe (m/s);

Δb = total head loss in the suction and delivery pipes (m).

Consideration should be given to the head-increasing effect of choking of trashracks that usually protect the inlet section of drainage pumping stations from the entrance of floating debris such as mown aquatic weed, plastic, and branches, if timely cleaning of these racks is not secured.

The power requirement may be calculated using:

$$P = \frac{\rho g Q b}{\eta_t \eta_p} \quad (10)$$

where:

b = total head (m);

P = power required (kW);

Q = discharge rate (m³/s);

η_t and η_p are the transmission (0.90–0.95) and pump efficiencies, respectively;

ρ = density of water $\approx 1\,000 \text{ kg/m}^3$.

The η_p values can vary for axial pumps from 0.65 for 1-m lift to 0.80 for 2.5–3.0-m lift; for radial pumps from 0.6 for 1-m lift to 0.80–0.85 for lifts of more than 4.0 m (Smedema, Vlotman and Rycroft, 2004); and Archimedes screws may have an efficiency of 65–75 percent (Wijdieks and Bos, 1994).

Some correction factors may be also considered in Equation 10 in order to take account of the elevation of the site and safe load (Smedema, Vlotman and Rycroft, 2004).

REFERENCES

- ILRI. 1964. *Code of practice for the design of open watercourses and ancillary structures*. Bulletin 7. Wageningen, The Netherlands. 82 pp.
- Smedema, L.K., Vlotman, W.F. & Rycroft, D.W. 2004. *Modern land drainage. Planning, design and management of agricultural drainage systems*. Leiden, The Netherlands, A.A. Balkema Publishers, Taylor&Francis. 446 pp.
- Wijdieks, J. & Bos, M.G. 1994. Pumps and pumping stations. In H.P. Ritzema, ed. *Drainage principles and applications*, pp. 965–998. 2nd edition. ILRI Publication 16. Wageningen, The Netherlands, ILRI.

Annex 11

Example of the batch method for flat lands

The batch method for flat lands is described by means of an example for water distribution from an extreme rainfall, with data from the Ebro Delta in northeast Spain, where the climate is Mediterranean and extreme rainfalls are common in autumn. Although the rainfall period extends for several consecutive days, an exceptional rain of about 100 mm may fall in one day for a return period of 5 years. The following days are rainy but the amount of precipitation decreases progressively. These autumn rainfalls may affect irrigated rice fields during harvesting operations. On the left bank of the Ebro Delta, flat areas of 2 200–3 000 ha are served by drainage pumping stations managed by the local water users association. The farm in this example is served by a station with four Archimedes screws, each able to remove 9.5 mm/d, so that the maximum total capacity of the pumping station is 38 mm/d. During the irrigation period, only one of the pumps usually discharges about 5 mm/d, mainly surface drainage water from the rice fields. Table A11.1 shows the results of calculations based on the above data.

Although the rice fields are drained before harvesting by the existing surface drainage systems, the soil is almost saturated and storage can be considered negligible. However, about 25 mm can be stored in the channel system. On rainy days in autumn, evaporation can remove about 3 mm/d from the area.

It is assumed that, on the first day, the full pumping capacity of the station has to be started, evaporation is negligible and, therefore, only about 25 mm can be removed. The excess 75 mm cannot be stored in the soil and in the channels, so inundation occurs in the rice fields. In the following days, the four available screws work day and night. Subsequently, the inundation storage and the water in the channels are drained. These conditions are suitable for the rice field requirements.

However, in some areas of the Ebro Delta, vegetables are grown in fields with surface and subsurface drainage facilities. Heavy autumn rainfalls may affect crops such as tomato and lettuce severely. Table A11.2 shows the water distribution of extreme rainfalls for a 10-year return period with the existing shared pumping facilities. It is assumed that in these irrigated lands where the groundwater table is controlled by a subsurface drainage system, the soil becomes completely saturated after storing about 50 mm.

Even with all four pumps working fully, inundation cannot be avoided on two days. In addition to this, pumping should continue to lower the water level in the channels in order to allow the subsurface drainage system to drawdown the water level, at least

TABLE A11.1
Water balance of a rice field in a flat area

Day	Rainfall	Evaporation	Pumped water	Excess rainfall	Storage in:			Total
					Soil	Channels	Inundation	
(mm/d)								
1	100	-	25	75	-	25	50	75
2	21	3	38	55	-	25	30	55
3	4	3	38	18	-	18	-	18
4	-	3	15	-	-	-	-	-
5	-	3	5	-	-	-	-	-

TABLE A11.2
Water balance of a vegetable field in a flat area

Day	Rainfall	Evaporation	Pumped water	Excess rainfall	Storage in:			
					Soil	Channels	Inundation	Total
(mm/d)								
1	125	-	25	100	50	25	25	100
2	29	3	38	88	50	25	13	88
3	4	3	38	51	50	1	-	51
4	-	3	30	18	18	-	-	18
5	-	3	15	-	-	-	-	-

TABLE A11.3
Example of water balance for a 6-hour period

Hour	Rainfall	Evaporation	Pumped water	Excess rainfall	Storage in:			
					Soil	Channels	Inundation	Total
(mm/h)								
1	53	-	1	52.0	20	15	17.0	52.0
2	27	-	1.6	77.4	35	20	22.4	77.4
3	14	-	1.6	89.8	45	25	19.8	89.8
4	6	-	1.6	94.2	50	25	19.2	94.2
5	3	-	1.6	95.6	50	25	20.6	95.6
6	1	-	1.6	95.0	50	25	20.0	95.0

25 cm in one day. Inundation for two days could be tolerated by tomato and lettuce in the Ebro Delta, providing that they are grown on beds between surface drainage furrows. However, as the pumping requirements are higher than for standard rice field needs, individual pumping stations may be needed in farms with surface and subsurface drainage systems where vegetables are grown jointly with rice (as the actual shared pumping facilities were designed mainly for covering rice field requirements).

The pumping capacity should also be increased if the critical period is less than 24 hours as it is frequently needed to cultivate more sensitive crops. If heavy rain falls in the first three hours, soil storage may be limited by soil infiltration, which is usually highest at the beginning. However, it soon decreases, becoming later almost constant until the soil is saturated completely. In the example of Table A11.3, water distribution is shown with pumping capacity and channel storage similar to the previous example.

In this example, inundation reaches its maximum value after about 2 hours. After this time, it decreases slightly, but stagnation occurs in the following hours. If the critical period is about 6 hours and the excess rainfall should be removed during this time interval, the pumping capacity should be increased substantially or less sensitive crops should be cultivated. Consequently, in certain areas of the Ebro Delta, where horticultural crops are grown, in addition to the pumping stations for subsurface drainage water, independent pumping stations with a higher capacity discharge surface drainage water during the critical periods of heavy rainfall.

Annex 12

Cypress Creek formula

PRINCIPLES

The Soil Conservation Service (now called the Natural Resource Conservation Service) of the United States Department of Agriculture developed a simple formula called the Cypress Creek equation (NRCS, 1998):

$$Q = qA^{5/6} \quad (1)$$

where:

Q = design discharge (m³/s)
– not peak discharge as some flooding can take place;

q = $0.21 + 0.00744P_{24}$ = drainage coefficient related to the drainage area and the magnitude of the storm (cubic metres per second per square kilometre) (Ochs and Bishay, 1992);

P_{24} = 24-hour excess rainfall (mm) – the excess rainfall can be calculated with the CN graph, but considering that the CN method was developed for free drainage conditions; for storm periods longer than a day, the total rainfall excess is divided by the length of the storm period in days (Ochs and Bishay, 1992);

A = area served by the drain (square kilometres).

The equation was developed for the eastern portion of the United States of America. It is basically applicable for humid flat lands covering less than 5 000 ha, with conditions similar to the areas for which was developed.

Table A12.1 shows drainage coefficients for the east of the United States of America.

REFERENCES

- ASAE-EP 407.1. 1994. Agricultural drainage outlets - open channels. *In: American Society of Agricultural Engineers book of standards*, pp. 728–733. St. Joseph, USA.
- Natural Resource Conservation Service (NRCS). 1998. Water management (drainage). *Chapter 14 of Part 650 Engineering Field Handbook*. Washington, DC. 160 pp.
- Ochs, W.J. & Bishay, B.G. 1992. *Drainage guidelines*. World Bank Technical Paper No. 195. Washington, DC. 186 pp.

TABLE A12.1

Typical drainage coefficients for humid areas

	Drainage coefficient (m ³ s ⁻¹ km ⁻²)
Coastal plain cultivated	0.59
Delta cultivated lands	0.52
Cool northern cultivated	0.48
Coastal plain pasture	0.39
Cool northern pasture	0.33
Delta and coastal rice lands	0.30
Semi-humid northern cultivated	0.26
Semi-humid southern range lands	0.20
Coastal plain woodlands	0.13

Source: Adapted from ASAE-EP 407.1, 1994.

Annex 13

Statistical analysis of measured flows

PRINCIPLES

The maximum discharge at the outlet of the main drainage system can be determined statistically where a data series of measured flows is available covering a period of at least 15–20 years. For example, the occurrence probability can be calculated with the following formula:

$$P = \frac{m}{N+1} \quad (1)$$

where:

P = probability;

$T = 1/P$ = return period (years);

m = order number in the data series;

N = number of total data available.

Example

Equation 1 has been applied in the example shown in Table A13.1.

With the data of Table A13.1, the maximum discharge for a return period of up to 20 years can be determined (98.3 m³/s in this case), which is sufficient to design the main drainage system. Where a higher return period is required in order to design special structures, the design discharge can be estimated by extrapolation, once the

TABLE A13.1
Frequency analysis of drainage flows (for $N = 19$)

Year	Q_m (m ³ /s)	m	Q_m (m ³ /s)	m	$P = \frac{m}{N+1}$	$T = 1/P$ years
1967	85.1	4	98.3	1	0.05	20
1968	50.1	17	90.2	2	0.10	10
1969	48.2	18	85.3	3	0.15	
1970	68.3	10	85.1	4	0.20	5
1971	60.4	13	80.7	5	0.25	
1972	55.2	14	80.6	6	0.30	
1973	80.7	5	78.4	7	0.35	
1974	90.2	2	78.3	8	0.40	
1975	85.3	3	76.7	9	0.45	
1976	61.3	12	68.3	10	0.50	2
1977	98.3	1	61.5	11	0.55	
1978	78.4	7	61.3	12	0.60	
1979	80.6	6	60.4	13	0.65	
1980	36.7	19	55.2	14	0.70	
1981	50.2	15	50.2	15	0.75	
1982	61.5	11	50.2	16	0.80	
1983	50.2	16	50.1	17	0.85	
1984	78.3	8	48.2	18	0.90	
1985	76.7	9	36.7	19	0.95	1

Source: Adapted from Smedema, Vlotman and Rycroft, 2004.

available data are plotted on a probability paper, for example by using the normal distribution. However, this type of calculation is based on historical data, and runoff may change with changes in land use.

REFERENCES

- Smedema, L.K., Vlotman, W.F. & Rycroft, D.W.** 2004. *Modern land drainage. Planning, design and management of agricultural drainage systems*. Leiden, The Netherlands, A.A. Balkema Publishers, Taylor&Francis. 446 pp.

Annex 14

Unit hydrograph

PRINCIPLES

This method, developed by Sherman (1932), is based on the proportionality principle: the surface runoff hydrograph produced by certain amount of rainfall (P) can be obtained from the hydrograph of other storm of equal duration (P') by multiplying the ordinates of the latter hydrograph by the following conversion factor:

$$a = \frac{S_r}{S'_r} \quad (1)$$

where:

a = conversion factor;

S_r = amount of surface runoff produced by precipitation P (mm);

S'_r = amount of surface runoff produced by precipitation P' (mm).

This method is also based on the concept that the base length (t) of a hydrograph depends on the duration of the storm, but is independent of the amount of rainfall and surface runoff, as shown in Figure A14.1. The recession time ($t - t_d$) is almost constant. This is because it only depends on the physical characteristics of the basin.

For practical applications, it is advisable to convert the available hydrographs to unit hydrographs, namely, hydrographs for precipitations of 1 or 10 mm. Thus, for the project basin, a series of unit hydrographs can be obtained for different rainfall durations. In order to determine the hydrograph for the design rainfall, the unit hydrograph with a time basis similar to the design rainfall is selected.

Example

In Figure A14.2, the hydrograph for the surface runoff produced by a rainfall of 40 mm accumulated in 6 hours, of which 25 mm was accumulated in the first 3 hours, has

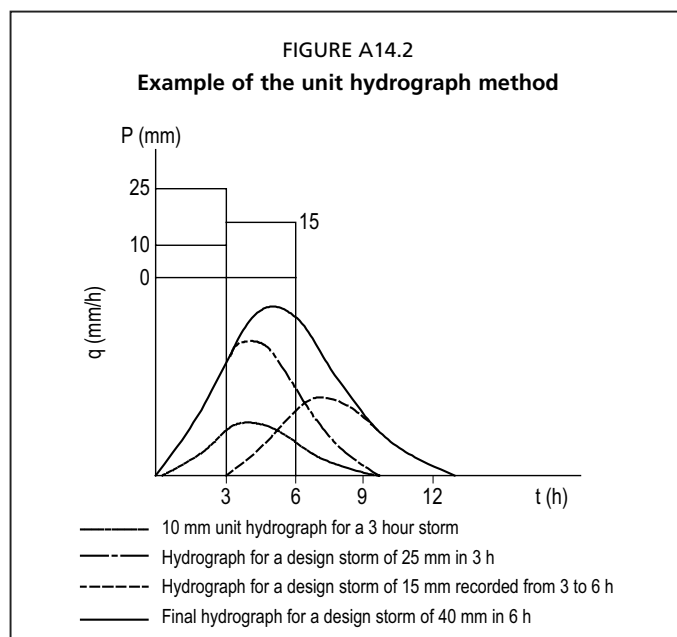
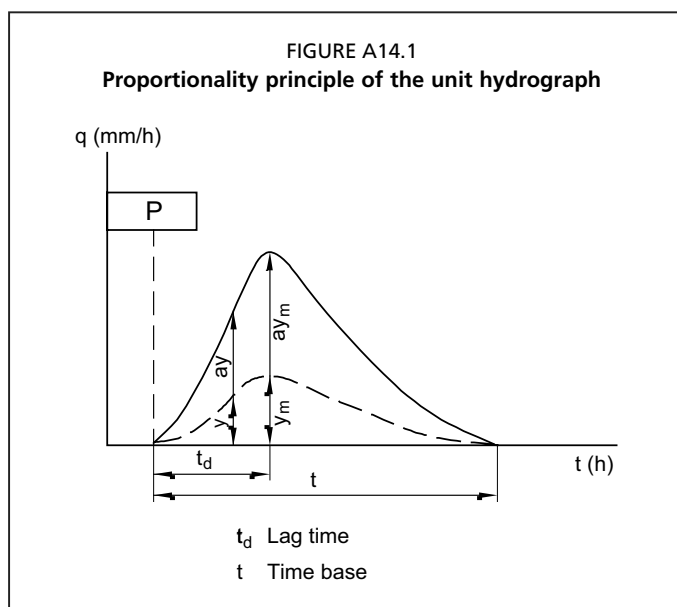

been determined from the unit hydrograph available for a rainfall of 10 mm in 3 hours. It is assumed that all rain becomes surface runoff.

The hydrograph for the first 3 hours is obtained from the 10-mm unit hydrograph by applying a conversion factor ($a = 2.5$). For the following 3-hour period, a conversion factor ($a = 1.5$) is used. The final hydrograph is obtained by superimposing both hydrographs. It can be observed that the peak discharge will be produced 5 hours after the beginning of the storm.

REFERENCES

- Sherman, L.K.** 1932. Streamflow from rainfall by the unit-graph method. *Eng. News Rec.*, 108: 501–505.

Annex 15

Rational formula

PRINCIPLES

The rational method assumes that, in small agricultural basins, the maximum flow of surface water in the outlet is for a rainfall with a duration equal to the concentration time. Then, the maximum discharge depends on the rainfall intensity, the surface area and the hydrological conditions of the basin:

$$Q_M = \frac{CIA}{360} \quad (1)$$

where:

Q_M = maximum discharge for a return period equivalent to the design rainfall (m³/s);

C = coefficient for surface runoff;

I = rainfall intensity during the concentration time (mm/h);

A = area of the basin (ha).

For the return period selected, rainfall intensity is assumed: (i) constant during the time interval considered; and (ii) equal to the ratio between the accumulated rainfall and the concentration time. Where only the amount of rainfall in 24 hours is known, the value of the precipitation accumulated in the concentration factor can be estimated, first by using an appropriate coefficient for the 6-hour rainfall ($P_6/P_{24} = 0.5-0.7$), and then with the coefficients of the rainfall distribution model described in Chapter 6 of the main text.

SURFACE RUNOFF COEFFICIENT

The runoff coefficient can be estimated directly through the indicative values of the Soil Conservation Service (SCS, 1972) shown in Table A15.1.

Example

The rational method has been applied to estimate the maximum discharge of surface water at the outlet (point D) of a farm of 85 ha shown in Figure A15.1.

In order to estimate the concentration time at point D , three sections have been considered from the most distant point from the outlet (point A): section AB (furrows), section BC (open collector drain), and section CD (the main drain).

Assuming values of the water velocity of 0.15 and 0.35 m/s along the furrows and the open ditches, respectively, Table A15.2 shows the concentration time t_c for each section as calculated using:

$$t_c = \sum_{i=1}^n \frac{l_i}{V_i} \quad (2)$$

where:

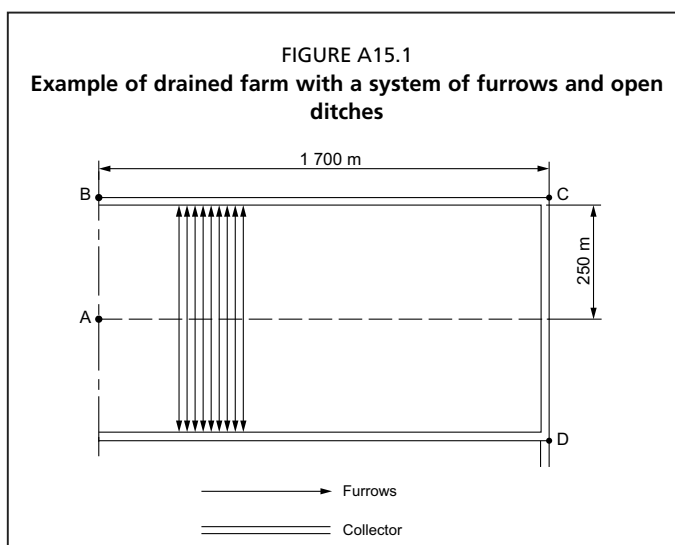

TABLE A15.1
Indicative values of the surface runoff coefficient for agricultural land

Land use	Slope (%)	Soil infiltrability		
		High	Medium	Low
Arable land	< 5	0.30	0.50	0.60
	5–10	0.40	0.60	0.70
	10–30	0.50	0.70	0.80
Pasture	< 5	0.10	0.30	0.40
	5–10	0.15	0.35	0.55
	10–30	0.20	0.40	0.60
Forest	< 5	0.10	0.30	0.40
	5–10	0.25	0.35	0.50
	10–30	0.30	0.50	0.60

Source: Adapted from Smedema, Vlotman and Rycroft, 2004.

TABLE A15.2
Estimates of the concentration time

Section	Length (m)	Slope (%)	Difference of elevation (m)	Water velocity (m/s)	t_c (h)
AB	250	0.10	0.25	0.15	0.46
BC	1 700	0.15	2.55	0.35	1.35
CD	500	-	-	0.35	0.40
AD	2 450		2.80		2.21

t_c = concentration time (s);

l_i = distance of section i (m);

v_i = average water velocity in section i (m/s).

The concentration time can also be estimated using the Kirpich formula:

$$t_c = \frac{K^{0.770}}{3080} \quad (3)$$

In this case:

l = distance AD = 2 450 m;

h = difference of elevation between A and D = 2.8 m;

s = h/l = average slope between A and D = 0.00114;

$$K = \frac{l}{\sqrt{s}} = \text{constant} = 72\,471.98 \text{ (m)};$$

t_c = concentration time = 1.79 h.

The values obtained for t_c are around an average value of 2 h, which can be used for further calculations. If during this time the accumulated rainfall for a return period of 5 years is 64 mm, the rainfall intensity is about 32 mm/h.

The runoff coefficient according to Table A15.1 is about 0.3. Then, the maximum flow at point D is about 2.3 m³/s, as calculated with Equation 1.

REFERENCES

- Smedema, L.K., Vlotman, W.F. & Rycroft, D.W. 2004. *Modern land drainage. Planning, design and management of agricultural drainage systems*. Leiden, The Netherlands, A.A. Balkema Publishers, Taylor&Francis. 446 pp.
- Soil Conservation Service (SCS). 1972. Hydrology. *National Engineering Handbook Section 4*. Washington, DC, USDA.

Annex 16

Curve Number method

PRINCIPLES

The Curve Number (CN) method is based on the conceptual interpretation of the hydrological process during a rainfall period. Initially, no surface runoff (S_r) is produced while rainfall is intercepted by vegetation and water infiltrates into the soil (I_a). When rainfall exceeds this initial interception, overland flow begins while soil infiltration continues (I_{nf}). Once the soil is saturated, any amount of excess rainfall (P) produces surface runoff (Figure A16.1).

Figure A16.2 shows the relationship between the precipitation accumulated and surface runoff during a rainfall period.

The amount of S_r is zero if the accumulated rainfall is lower than the I_a value. Once this threshold value has been exceeded, the S_r function takes a curve shape up to the saturation point where S_r is equal to P . From this point, the S_r function becomes a straight line with unit slope ($\alpha = 45^\circ$). If this line is extended to cut the x-axis, a point is achieved that represents the maximum retention potential (S). The S value depends on the physical characteristics of the basin and on the soil moisture content before the rainfall period.

Once overland flow starts, the water balance on the soil surface is:

$$I_{nf} = (P - I_a) - S_r \quad (1)$$

where:

I_{nf} = actual infiltration while surface runoff is produced (mm);

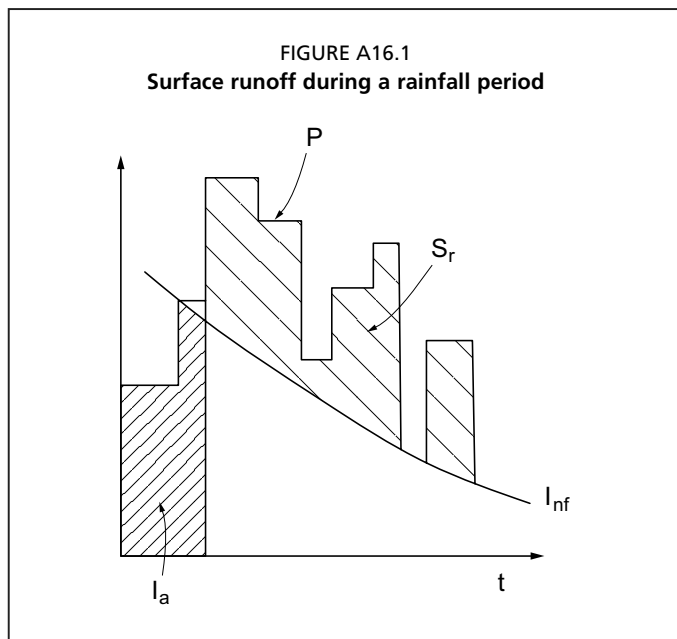

Source: Adapted from Boonstra, 1994.

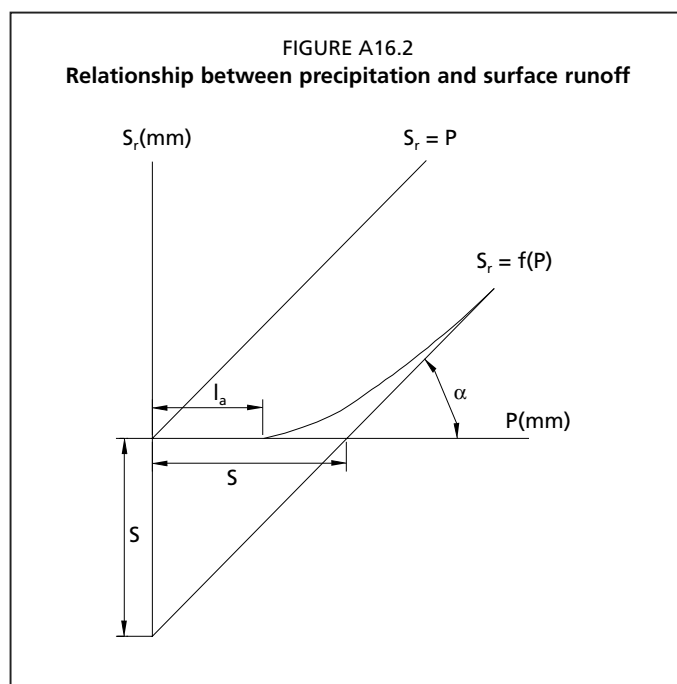

- I_a = amount of water intercepted and infiltrated into the soil before overland flow occurs (mm);
 P = amount of accumulated rainfall (mm);
 $P - I_a$ = maximum potential of surface runoff (mm);
 S_r = accumulated surface runoff (mm).

This method, developed by the Soil Conservation Service (SCS), assumes that the relationship between the actual surface runoff and its maximum potential value is equal to the rate between the actual infiltration and the maximum potential retention. The latter is approximately equal to the accumulated infiltration after runoff has started (Figure A16.2):

$$\frac{S_r}{P - I_a} = \frac{(P - I_a) - S_r}{S} \quad (2)$$

where:

S = maximum potential retention (mm).

Surface runoff can be then expressed as:

$$S_r = \frac{(P - I_a)^2}{(P - I_a) + S} \quad (3)$$

Equation 3 has been simplified by assuming that the value of the potential retention is constant during a storm and the initial interception is about 20 percent of the maximum potential retention ($I_a = 0.2S$). Thus, surface runoff depends only on precipitation and the maximum potential retention:

$$S_r = \frac{(P - 0.2S)^2}{P + 0.8S} \quad \text{for } P > 0.2S \quad (4)$$

The SCS formulated a new undimensional parameter, named the Curve Number (CN), to assess the capacity of a basin to produce surface runoff after certain precipitation. This parameter is a hydrological characteristic of the basin, which depends on the maximum potential retention:

$$CN = \frac{25400}{254 + S} \quad (5)$$

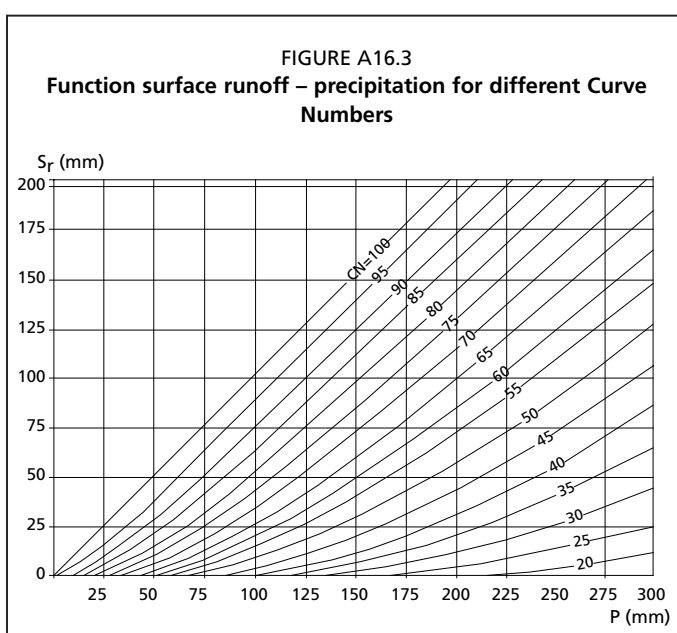

Source: Adapted from Boonstra, 1994.

By combining Equations 4 and 5, one expression can be obtained to calculate the accumulated surface runoff from the amount of rainfall and the CN. Figure A16.3 shows the function S_r/P in the graph developed by the SCS (1972) for different CN values.

Thus, in a basin characterized by a certain CN, the amount of surface runoff produced by a design rainfall can be estimated by means of Figure A16.3 or through Equations 4 and 5.

ESTIMATION OF THE CURVE NUMBER

The CN value depends on:

- the natural vegetation and the current land use;

- the hydrological soil characteristics, especially the infiltration;
- the agricultural practices;
- the previous soil moisture content.

This method does not consider land slope because lands with gradients of more than 5 percent are not cultivated in the United States of America. However, classes for different slopes can be considered in a specific project (Boonstra, 1994).

The CN value increases progressively as retention decreases, the maximum value being 100 where retention is negligible. Table A16.1 shows the CN values established by the SCS (1972) for average soil moisture conditions before the design storm, considered as Class II.

In Table A16.1, the term straight rows means rows along the land slope. The hydrological condition essentially depends on the vegetation density. Condition is poor where meadows are intensively used or the grass quality is low, or where field crops are in the initial stage of growing. Otherwise, condition is good for densely vegetated meadows and for field crops covering the soil surface well.

In addition to the average soil moisture conditions considered in Table A16.1 for Class II, the SCS defined two additional classes (I and III), taking into account the amount of precipitation in the five-day period before the design storm (Table A16.2).

If the antecedent soil moisture condition differs from Class II, the equivalent CN values for Class I or Class III can be estimated by using the conversion factors developed by the SCS (1972) and shown in Table A16.3, once the CN value has been determined for Class II.

TABLE A16.1
CN values Class II

Land use	Practice	Hydrological condition	Soil infiltrability			
			High	Medium	Low	Very low
Fallow	Straight row	Poor	77	86	91	94
Row crops	Straight row	Poor	72	81	88	91
		Good	67	78	85	89
	Contoured	Poor	70	79	81	88
		Good	65	75	82	86
	Contoured/terraced	Poor	66	74	80	82
		Good	62	71	78	81
Small grain	Straight row	Poor	65	76	84	88
		Good	63	75	83	87
	Contoured	Poor	63	74	82	85
		Good	61	73	81	84
	Contoured/terraced	Poor	61	72	79	82
		Good	59	70	78	81
Close-seeded legumes or rotational meadow	Straight row	Poor	66	77	85	89
		Good	58	72	81	85
	Contoured	Poor	64	75	83	85
		Good	55	69	78	83
	Contoured/terraced	Poor	63	73	80	83
		Good	51	67	76	80
Pasture range		Poor	68	79	86	89
		Fair	49	69	79	84
		Good	39	61	74	80
	Contoured	Poor	47	67	81	88
		Fair	25	59	75	83
		Good	6	35	70	79
Meadow (permanent)		Good	30	58	71	78
Woodland		Poor	45	66	77	83
		Fair	36	60	73	79
		Good	25	55	70	77

Source: Adapted from Boonstra, 1994.

TABLE A16.2
Classes for previous soil moisture conditions

Class	P in the previous 5-day period	
	Dormant season	Growing season
	(mm)	
I	< 13	< 36
II	13–28	36–53
III	> 28	> 53

Source: Adapted from Boonstra, 1994.

TABLE A16.3
Equivalent CN according to the antecedent soil moisture classes

Class	CN										
I	100	78	63	51	40	31	22	15	9	4	0
II	100	90	80	70	60	50	40	30	20	10	0
III	100	96	91	85	78	70	60	50	37	22	0

Source: Adapted from Boonstra, 1994.

In order to estimate the average CN value of a basin, all the sections with different hydrological conditions, land use and agricultural practices should first be mapped. Then, the respective CN is assigned to each independent section. Last, the weighted average is calculated according to the surface area of each section.

Example

In this example, the CN method has been applied to estimate the amount of surface runoff produced by an extreme rainfall of 125 mm in 24 hours, determined for a return period of 10 years, in a basin of 4 740 ha, where the current land use is rainfed agriculture and forest. This was the previous stage to calculate later the maximum water flow at the outlet of the main watercourse draining the basin.

The first step for this calculation was to estimate the concentration time of the basin with the Kirpich formula (although this formula was developed for small agricultural basins). For a watercourse with a length of 15.5 km and a difference in elevation between the most distant point from the outlet and the outlet itself of 299.4 m, the t_c value is 2.5 hours.

The second step was to assess the rainfall distribution during the first 6 hours of the storm. This period of 6 hours was selected, because the concentration time is less than 6 hours. It was assumed that during the first 6 hours, 60 percent of the one-day precipitation occurred, i.e. 75 mm. The rainfall distribution during this period can be estimated by the WMO model for time intervals of 0.5 hours, as shown in Table A16.4.

In order to estimate the weighted average CN for the whole basin, the area was split into six sections with homogeneous land use and hydrological conditions by superimposing the land-use map and the soil map. The physical characteristics of these sections are described in Table A16.5, where the individual CN, estimated for Class II, were assigned to each section.

The weighted average CN for the basin as a whole is 69 for Class II (Table A16.5). However, the previous soil moisture conditions are more similar to those of Class III as in the area studied extreme rainfalls are frequent in autumn. Therefore, it is more adequate to use the equivalent CN for Class III, i.e. 85 according to Table A16.3.

TABLE A16.4
Distribution of the total precipitation in a period of 6 hours

Time (h)	0.5	1.0	1.5	2.0	2.5	3.0	3.5	4.0	4.5	5.0	5.5	6.0
Rainfall distribution (%)	2	8	15	22	60	70	78	84	88	92	96	100
Accumulated rainfall (mm)	1.5	6.0	11.3	16.5	45.0	52.5	58.5	63.0	66.0	69.0	72.0	75.0

TABLE 16.5
Physical characteristics and CN values of the hydrologically homogeneous sections

Section	Surface area (ha)	Soil type	Land use	Agricultural practice	Infiltrability	CN
1	762	Shallow soils on shale rock	Pasture		Low	79
2	1 566		Woodland & pasture		Medium	69
3	1 161	Terraced deep soils	Vineyard		Medium	71
4	990	Terraced deep soils	Field crops	Straight rows	High	59
5	30	Terraced soils	Dense field crops		Low	76
6	231	Moderately shallow soils with slopes > 2%	Pasture		Low	74
Basin	4 740					69

TABLE A16.6
Estimation of the amount of surface runoff for CN = 85

Time (h)	0.5	1.0	1.5	2.0	2.5	3.0	3.5	4.0	4.5	5.0	5.5	6.0
Accumulated rainfall (mm)	1.5	6.0	11.3	16.5	45.0	52.5	58.5	63.0	66.0	69.0	72.0	75.0
Accumulated runoff (mm)			0.1	1.1	16.1	21.5	26.0	29.5	31.9	34.4	36.8	39.3
ΔS_r (mm)			1.0	15.0	5.4	4.5	3.5	2.4	2.5	2.4	2.5	

The maximum potential retention for this CN is 44.8 mm (Equation 5). With this value, the surface runoff produced for the design rainfall can be calculated with Equation 4 or estimated by means of Figure A16.3. Table A16.6 shows the results.

HYDROGRAPH OF THE SPECIFIC DISCHARGE

The dimensionless unit hydrograph developed by the SCS can be used to calculate the maximum specific discharge of surface runoff and the maximum water flow. In this hydrograph, time is expressed as a function of the elevation time, and discharge is related to its maximum value. Figure A16.4 shows this hydrograph and a table with average values.

From numeric integration of this hydrograph, the following expression can be obtained for the maximum specific discharge:

$$q_M = 2.08 \frac{S_r}{t_e}$$

where:

q_M = maximum specific discharge (litres per second per hectare);

S_r = amount of surface runoff (mm);

t_e = elevation time (h).

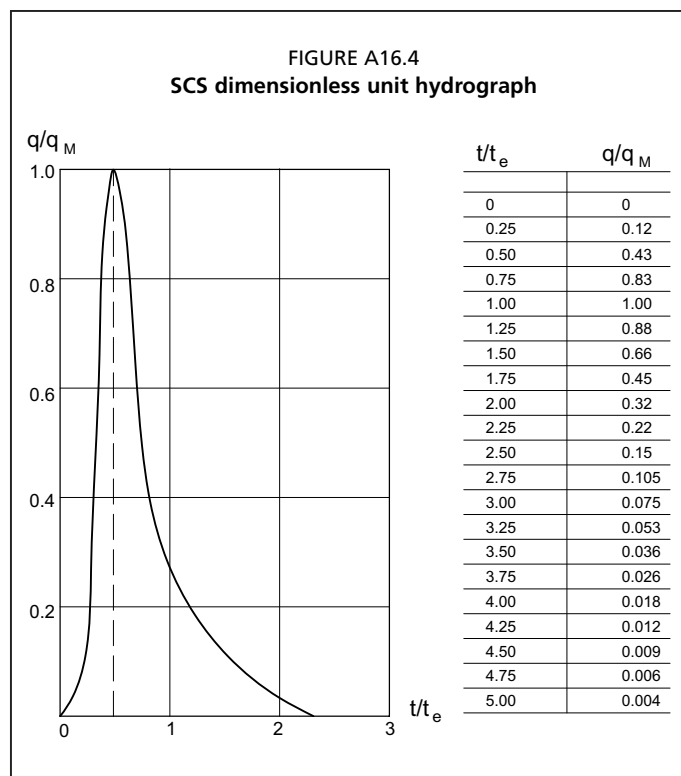

Source: Adapted from Boonstra, 1994.

(6)

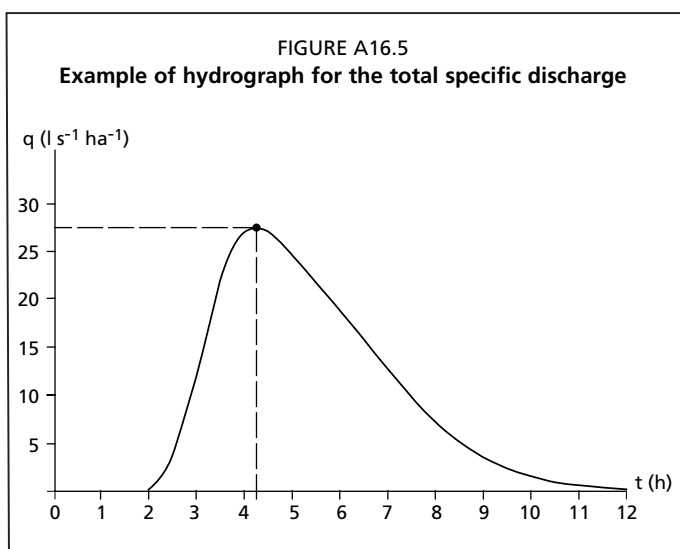

The t_e value can be estimated from the concentration time ($t_e \approx 0.7t_c$).

Example

The elevation time (t_e) in the basin of the previous example is about 1.75 hours. With this value, in Table A16.7 the maximum specific discharge (q_M) for each increment of surface runoff (ΔS_r) has been calculated with Equation 6. In Table A16.7, the distribution of the specific discharge has also been determined by applying the tabulated values of the undimensional hydrograph represented in Figure A16.4 to the q_M values.

The hydrograph for the total specific discharge (Figure A16.5) was obtained by superimposing the partial hydrographs obtained with the results of Table A16.7.

TABLE A16.7
Calculation of the partial specific discharges q_M and the total discharge q_t

t (h)	Undimensional hydrograph	t (h)										q _t (l s ⁻¹ ha ⁻¹)
		ΔS _r (mm) (see Table A16.6)										
		1.5	2.0	2.5	3.0	3.5	4.0	4.5	5.0	5.5		
		1.0	15.0	5.4	4.5	3.5	2.4	2.5	2.4	2.5		
		$q_M = 2.08 S_r/t_e = 1.19S_r$										
	t/t _e q/q _M	1.2	17.9	6.4	5.4	4.2	2.9	3.0	2.9	3.0		
0.0	0.00	0.00										
0.5	0.29	0.17										
1.0	0.57	0.54										
1.5	0.86	0.91										
2.0	1.14	0.93	0.20								0.20	
2.5	1.43	0.72	0.65	3.04							3.69	
3.0	1.71	0.48	1.09	9.67	1.09						11.85	
3.5	2.00	0.32	1.12	16.29	3.46	0.92					21.79	
4.0	2.29	0.21	0.86	16.65	5.82	2.92	0.71				26.96	
4.5	2.57	0.14	0.58	12.89	5.95	4.91	2.27	0.49			27.09	
5.0	2.86	0.09	0.38	8.59	4.61	5.02	3.82	1.57	0.51		24.50	
5.5	3.14	0.06	0.25	5.73	3.07	3.89	3.91	2.64	1.62	0.49	21.60	
6.0	3.43	0.04	0.17	3.76	2.05	2.59	3.02	2.70	2.73	1.57	19.10	
6.5	3.71	0.03	0.11	2.51	1.34	1.73	2.02	2.09	2.79	2.64	16.85	
7.0	4.00	0.02	0.07	1.61	0.90	1.13	1.34	1.39	2.16	2.70	14.03	
7.5	4.29	0.01	0.05	1.07	0.58	0.76	0.88	0.93	1.44	2.09	10.59	
8.0	4.57	.008	0.04	0.72	0.38	0.49	0.59	0.61	0.96	1.39	7.34	
8.5	4.86	.005	0.02	0.54	0.26	0.32	0.38	0.41	0.63	0.93	4.93	
9.0	5.14	.003	0.01	0.36	0.19	0.22	0.25	0.26	0.42	0.61	3.28	
9.5	5.43		0.01	0.18	0.13	0.16	0.17	0.17	0.27	0.41	2.13	
10.0	5.71		0.01	0.14	0.06	0.11	0.13	0.12	0.18	0.26	1.43	
10.5	6.00			0.09	0.05	0.05	0.08	0.09	0.12	0.17	0.92	
11.0	6.29			0.05	0.03	0.04	0.04	0.06	0.09	0.12	0.61	
11.5	6.57				0.02	0.03	0.03	0.03	0.06	0.09	0.38	
12.0	6.86					0.02	0.02	0.02	0.03	0.06	0.24	
12.5	7.14						0.01	0.01	0.02	0.03	0.13	
13.0	7.43							0.01	0.02	0.02	0.08	
13.5	7.71								0.01	0.01	0.04	
14.0	8.00									0.01	0.03	

Figure A16.5 shows that about 4 hours after the beginning of the design storm the maximum specific discharge is expected, its value then being about $27 \text{ l s}^{-1} \text{ ha}^{-1}$. With this surface drainage coefficient, each section of the main drainage system can be dimensioned. At the outlet of this basin of 4 740 ha, the maximum estimated flow will be about $128 \text{ m}^3/\text{s}$.

REFERENCES

- Boonstra, J.** 1994. Estimating peak runoff rates. In H.P. Ritzema, ed. *Drainage principles and applications*, pp. 111–143. 2nd edition. ILRI Publication 16. Wageningen, The Netherlands, ILRI.
- Soil Conservation Service (SCS).** 1972. Hydrology. *National Engineering Handbook Section 4*. Washington, DC, USDA.

Annex 17

Formulae for steady-state flow to drains

This annex gives formulae for the calculation of open or covered parallel drain spacings for use for different soil profiles.

FLOW ABOVE DRAIN LEVEL; THE ELLIPSE EQUATION

The ellipse equation (Figure A17.1) is valid for a single layer above drain level (Van der Ploeg, Marquardt and Kirkham, 1997).

Where an impermeable layer is present at drain level, the phreatic groundwater table between two drains has an elliptic shape. The resulting formula for the drain spacing then equals:

$$L^2 = \frac{4Kh^2}{q} \quad (1)$$

where:

h = groundwater elevation mid-way drains (m);

K = permeability above drain level (m/d);

L = drain spacing (m);

q = design discharge (m/d).

The ellipse formula is used in the programs for the flow above drain level, either as the only discharge or in combination with flow through deeper layers.

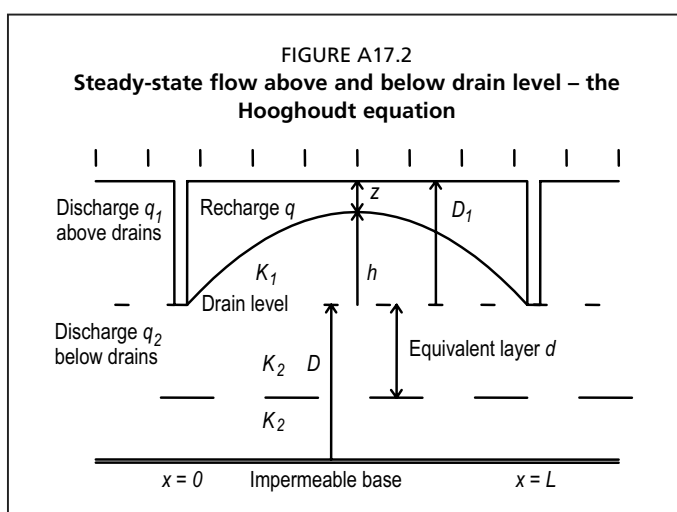
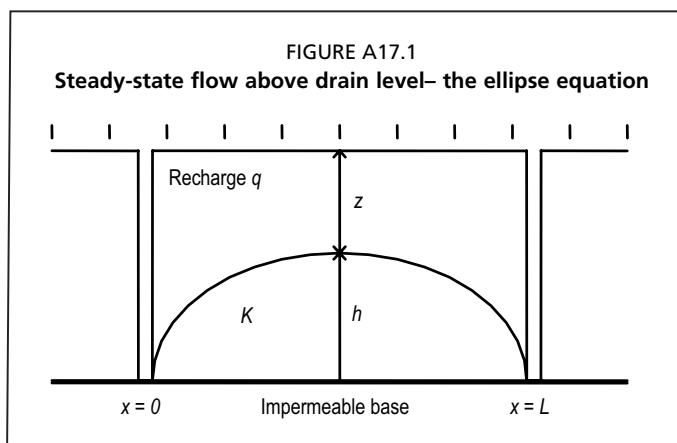

FLOW ABOVE AND BELOW DRAIN LEVEL; THE HOOGHOUTD EQUATION

The Hooghoudt approach (Hooghoudt, 1940) considers a soil that is either homogeneous above and below the drain level or consists of two layers with different properties above and below drain level (Figure A17.2). Hooghoudt's formula for calculating drain spacings under steady-state flow assumptions is:

$$L^2 = \frac{4K_1h^2 + 8K_2dh}{q} \quad (2)$$

where:

$d = f(D_2, L, r)$ = effective thickness of lower layer (m);

D_1 = thickness of the layer above drain level (m) – mentioned in Figure A17.2;

D_2 = real thickness of the layer below drain level, down to the impermeable subsoil (m);

K_1 = permeability above drain level (m/d);

K_2 = permeability below drain level (m/d);

r = effective drain radius (m).

Inputs for Equation 2 are D_2 , b , K_1 , K_2 , q and r , of which D_2 may be infinite. Because d depends on the required distance L , iteration is necessary.

Hooghoudt's method for calculating drain spacings is valid for a two-layered soil profile: one layer above and one below drain level. The latter not only offers resistance to horizontal flow, but also radial resistance that occurs near the drain, where the streamlines are converging.

In this approach, the flow pattern is replaced by horizontal flow through a thinner layer; the actual thickness D_2 of the layer below the drains is replaced by the equivalent layer d without radial resistance (Figure A17.2). For steady-state flow, this is allowed, but errors may occur in non-steady cases.

The equivalent layer d , which is a complicated function, is used as a substitute correction for the radial resistance caused by the convergence of streamlines near the drain. It is smaller than the real thickness D_2 of the lower layer and was tabulated by Hooghoudt. Subsequently, nomographs were based on these tables (Van Beers, 1979). However, for computer applications a series solution is more effective. The following series solution may be used to find d :

$$d = \frac{\pi L / 8}{\ln \frac{L}{\pi r} + G(x)} \quad x = \frac{2\pi D_2}{L} \quad (3)$$

$$G(x) = \frac{4e^{-2x}}{1(1-e^{-2x})} + \frac{4e^{-6x}}{3(1-e^{-6x})} + \frac{4e^{-10x}}{5(1-e^{-10x})} + \frac{4e^{-14x}}{7(1-e^{-10x})} + \dots \quad (4)$$

which converges rapidly for $x > 0.5$.

For smaller values of x , Dagan's formula results in the expression:

$$G(x) = \frac{\pi^2}{4x} + \ln \frac{x}{2\pi} \quad (5)$$

These formulae are well-suited for computer application.

ERNST EQUATION

The Ernst method (Ernst, 1956) for calculating drain spacings allows two-layered profiles with a horizontal boundary at arbitrary level but not necessarily at drain depth (Figure A17.3). If homogeneous, layers 1 and 2 are supposed to be of equal composition ($K_2 = K_1$ and $an_2 = an_1$).

In this method, the flow is divided into three parts, each of which is calculated:

➤ a vertical flow to the aquifer, with a vertical head loss h_v ;

➤ a horizontal flow to the vicinity of the drain, with horizontal head loss h_b ;

➤ a radial flow towards the drain, with radial head loss h_r .

The total head loss in the soil h is:

$$h = h_v + h_b + h_r \quad (6)$$

The theory gives rise to a quadratic equation in L .

THE TOKSÖZ–KIRKHAM ALGORITHM

Toksöz and Kirkham (1971a and 1971b) devised a general theory for determining drain spacings in multilayered soils with arbitrary horizontal boundaries (Figure A17.3). It consists of a set of complicated hyperbolic functions that depend on the number and thickness of layers considered.

The method calculates the flow through 1–3 different layers below drain level (Figure A17.3). It uses the following definitions:

- The layer above drain level has permeability K_1 . It is not considered in the theory, but the resulting flow can be calculated by Equation 1.
- The first layer below drain level has permeability K_2 and thickness D_2 .
- The second layer below drain level has permeability K_3 and thickness D_3 .
- The third layer below drain level has permeability K_4 and thickness D_4 .
- The drain spacing is L , the drain radius r , the recharge intensity q , and the head midway b .

Distances a , b , c and s are defined as:

$$a = D_2 \quad b = D_2 + D_3 \quad c = D_2 + D_3 + D_4 \quad s = \frac{L}{2} \quad (7)$$

The following auxiliary quantities are calculated:

$$\alpha_m = \frac{K_4}{K_3} \frac{1}{\cosh \frac{m\pi(b-a)}{s}} \quad \beta_m = \frac{K_4}{K_3} \coth \frac{m\pi b}{s} \quad \gamma_m = \tanh \frac{m\pi(c-b)}{s} \quad (8.a)$$

$$\delta_m = \tanh \frac{m\pi(b-a)}{s} \quad \eta_m = \frac{\sinh \frac{m\pi a}{s}}{\sinh \frac{m\pi b}{s}} \quad \rho_m = \frac{K_3}{K_2} \coth \frac{m\pi a}{s} \quad (8.b)$$

$$\mu_m = \frac{\cosh \frac{m\pi a}{s}}{\sinh \frac{m\pi b}{s}} \quad \epsilon_m = \frac{K_3}{K_2} \frac{1}{\sinh \frac{m\pi a}{s}} \quad (8.c)$$

Furthermore:

$$S_m = m e^{\frac{m\pi a}{s}} \quad (9)$$

$$T_m = \frac{1}{m} \frac{\epsilon_m}{(1 + \delta_m \rho_m)(1 + \beta_m \gamma_m) + \alpha_m \gamma_m (\rho_m \eta_m - \mu_m)} \quad (10)$$

$$U_m = 1 - S_m T_m \delta_m - S_m T_m \gamma_m (\delta_m \beta_m + \alpha_m \eta_m) \quad (11)$$

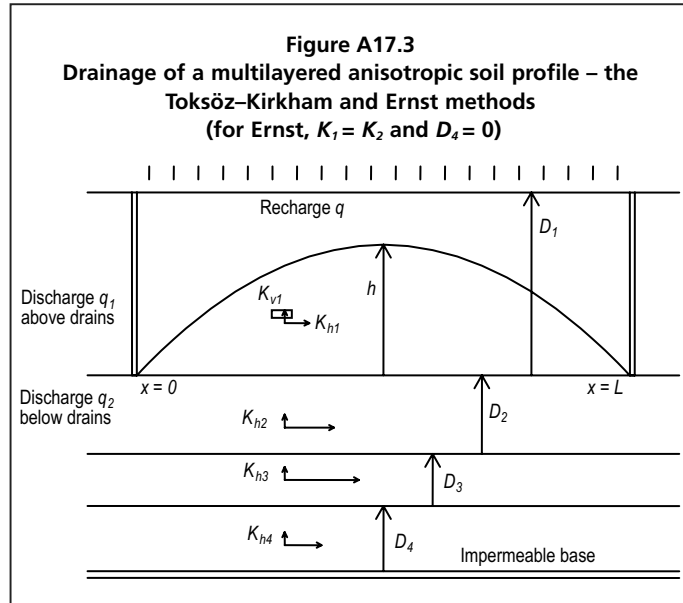

The head h midway between drains is determined from:

$$h = \frac{2sq}{\pi(K_2 - q)} \left\{ -\ln \sin \frac{\pi r}{2s} + \sum_{m=1}^{\infty} \frac{1}{m} \left[-1 + \coth \left(\frac{m\pi a}{s} \right) \right] \left[\cos \frac{m\pi r}{s} - \cos(m\pi) \right] U_m \right\} \quad (12)$$

Combination with the ellipse equation for flow above drains requires an iterative solution.

These formulae are suited for computer applications.

INFLUENCE OF ANISOTROPY

In many soils, permeability depends on the direction of flow. Considerations here are confined to horizontal layering and vertical cracks. The former results in a permeability that is larger in the horizontal than in the vertical direction, the latter in the reverse.

In such cases, where the axes of the anisotropy coincide with the horizontal and vertical x and z axes, the following rules may be used (Boumans, 1963):

➤ An “anisotropy factor” an_i is defined for each layer i as:

$$an_i = \frac{K_{hi}}{K_{vi}} \quad (13)$$

with K_h horizontal and K_v vertical permeability of layer i .

➤ Hydraulic heads and discharges remain the same.

➤ Horizontal distances remain the same.

➤ Vertical distances z_i in layer i (especially thickness D_i) are transformed to:

$$\zeta_i = z_i \sqrt{an_i} \quad (14)$$

➤ The permeability is transformed to:

$$\kappa_i = \frac{K_{hi}}{\sqrt{an_i}} \quad (15)$$

In this transformed isotropic system (Figure A17.4), all formulae for steady-state flow are valid. The resulting spacing L is horizontal and, consequently, it remains unchanged.

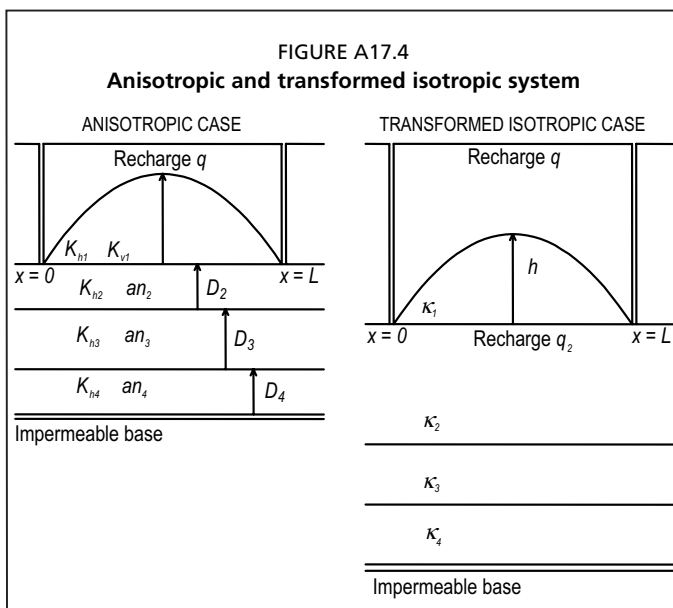

For flow above drains, a different approach is used. Here, the vertical permeability K_{v1} of the first layer is used to find the head loss between maximum head h and drain level and, consequently, the corrected head h_c (the head at drain level) as:

$$h_c = h \left(1 - \frac{q}{K_{v1}} \right) \quad (16)$$

With this corrected head, all subsequent calculations are executed.

The program SPACING is based on the above theory. However, the Ernst equation is not included. In cases where it is applicable, it gives practically the same results as the more general Toksöz-Kirkham algorithm.

REFERENCES

- Boumans, J.H.** 1963. Een algemene nomografische oplossing voor het stationaire ontwateringsvraagstuk met toepassingen voor isotroop en anisotroop doorlatende gronden. *Polytechn. Tijdschr.*, 18(14B): 545–551.
- Ernst, L.F.** 1956. Calculation of the steady flow of groundwater in vertical cross-sections. *Neth. J. of Agr. Sci.*, 4: 126–131.
- Hooghoudt, S.B.** 1940. Algemeene beschouwing van het probleem van de detailontwatering en de infiltratie door middel van parallel loopende drains, greppels, slooten en kanalen. *Versl. Landbouwk. Onderz.*, 46(14).
- Toksöz, S. & Kirkham, D.** 1971a. Steady drainage of layered soils: I, Theory. *J. Irr. Dr. Div. ASCE*, 97, IR1, 1–18. Erratum in *J. Irr. Dr. Div. ASCE*, 104, IR3, 333.
- Toksöz, S. & Kirkham, D.** 1971b. Steady drainage of layered soils: II, Nomographs. *J. Irr. Dr. Div. ASCE*, 97, IR1, 19–37.
- Van Beers, W.F.J.** 1979. *Some nomographs for the calculation of drain spacings*. ILRI Bulletin 8. Wageningen, The Netherlands.
- Van der Ploeg, R.P., Marquardt, M. & Kirkham, D.** 1997. On the history of the ellipse equation for soil drainage. *Soil Sci. Soc. Am. J.*, 61: 1604–1606.

Annex 18

Drainage under vertical seepage

INFLUENCE OF VERTICAL SEEPAGE

Artesian seepage (upward flow from deeper layers) is caused by groundwater flow from higher areas. The sources may be nearby (e.g. irrigated lands on higher grounds) or far away (through aquifers under pressure recharged in hills or mountains). Water escaping from such aquifers causes upward flow to the rootzone. Drainage of such seepage areas is often difficult. In many cases, temporary or even permanent wetness and salinization occur.

Two main methods have been proposed for drain spacing design under these conditions:

- Vertical drainage is a good solution under special hydrological conditions. Therefore, where there is no previous experience in the region, a careful hydrogeological survey is needed.
- Relief wells are another possibility where the aquifer is under pressure.

Where neither of these solutions is applicable, drains need to be laid at a narrower spacing than normal. In this case, a formula developed by Bruggeman (Van Drecht, 1983; Bruggeman, 1999) can be used. However, in severe cases, where the drain spacing must be greatly reduced, it is often better to leave the area as a wetland.

BRUGGEMAN'S FORMULA FOR ARTESIAN CONDITIONS

For horizontal drainage under artesian conditions, Bruggeman's method may be used. This calculates flow below drain level under the following circumstances (Figure A18.1):

- a moderately permeable top layer, in which the drains are located, overlies a highly ("infinitely") permeable aquifer;
- between the top layer and the aquifer a semi-confining layer (aquitard) occurs;
- the artesian head in the aquifer may be above drain level as well as below (in the latter case, natural downward drainage will occur);
- the artesian head is not influenced by the drainage system.

The final condition is seldom respected in large projects. Such works usually exert a profound influence on the underlying aquifer. This limits the applicability of the method to rather small areas. In large projects, combination with a geohydrological model of the aquifer is indispensable. The model SAHYSMOD (ILRI, 2005) can be used for this combination. It also allows an analysis of the salt balance.

Because flow above drain level is not considered in the Bruggeman formulae, the ellipse equation can be used to calculate this part of the flow.

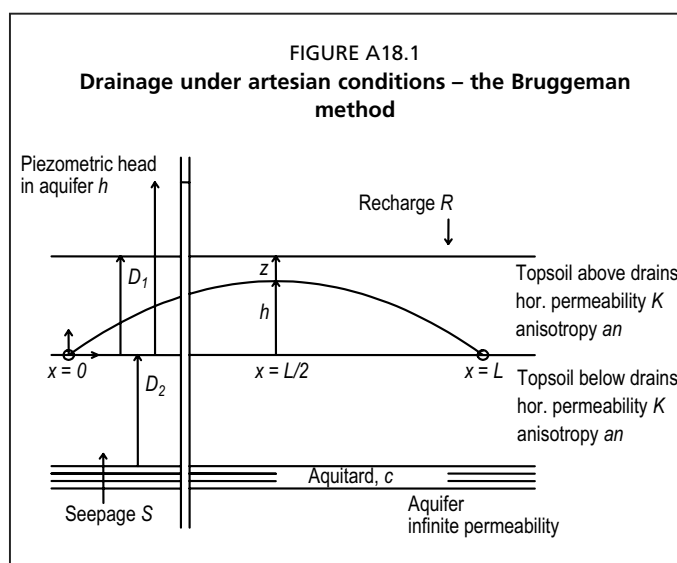

Spacings are to be calculated for two cases:

- high recharge by heavy rain or irrigation, in combination with a criterion for groundwater table depth under such wet conditions;
- zero recharge, with a criterion for a design groundwater depth under dry conditions, deep enough to avoid permanent wetness in humid climates and salinization in arid regions.

For the latter, groundwater should remain below a critical depth.

Bruggeman derived the following algorithm for two-dimensional flow below drain level under artesian conditions (Figure A18.1):

$$Q_2 = \frac{\left[\left(c + \frac{D_2}{K_{2v}} \right) \left(1 - \frac{u}{L} \right) - u \Sigma_1 \right] (P - q_1) + b}{\frac{c_b}{u} + \frac{\left(c + \frac{D_2}{K_{2v}} \right)}{L} + \Sigma_1} \quad (1)$$

$$\Sigma_1 = \frac{a_B L^2}{\pi^3 u^2 K_{2v}} \sum_{n=1}^{\infty} \frac{1}{n^3} \sin^2 \left(\frac{n\pi u}{L} \right) F(n, 0) \quad (2)$$

$$F(n, z) = \frac{(n\alpha_1 + 1) e^{n\alpha_2} + (n\alpha_1 - 1) e^{-n\alpha_2}}{(n\alpha_1 + 1) e^{n\alpha_3} - (n\alpha_1 - 1) e^{-n\alpha_3}} \quad (3)$$

$$a_B = \sqrt{\frac{K_{2v}}{K_{2b}}} \quad \alpha_1 = \frac{2\pi K_{2v} c}{a_B L} \quad \alpha_2 = \frac{2\pi (D_2 - y)}{a_B L} \quad \alpha_3 = \frac{2\pi D_2}{a_B L} \quad (4)$$

At drain level, where $y = 0$ and $\alpha_2 = \alpha_3$:

$$F(n, 0) = \frac{(n\alpha_1 + 1) + (n\alpha_1 - 1) e^{-2n\alpha_3}}{(n\alpha_1 + 1) - (n\alpha_1 - 1) e^{-2n\alpha_3}} \quad (5)$$

The flux density is:

$$q_2 = \frac{Q_2}{L - u} \quad (6)$$

where:

c = resistance of semi-confining layer (d);

c_b = entry resistance of drain ($c_b = 0$) (d);

D_2 = thickness of layer below drain level (m);

b = head midway, at drain level (m);

h_a = head in artesian aquifer, above drain level (m) (in Figure A18.1);

K_{2b} = horizontal permeability below drains (m/d);

K_{2v} = vertical permeability below drains (m/d);

L = drain spacing (m);

q_2 = flux density below drain level (m/d);

Q_2 = flux below drain level, per metre of drain (m²/d);

R = recharge by precipitation or irrigation excess (m/d) (in Figure A18.1);

u = wet circumference of drain (m);

y = vertical coordinate, positive downward (m).

For artesian conditions and a two-layer profile (one of which is below drain level), the design program ARTES was developed. It is based on Bruggeman's algorithm, in combination with flow above drain level according to the ellipse equation.

It also requires general design criteria. These are followed by the soil properties, which now include the hydraulic head in the underlying artesian aquifer and the vertical resistance of a semi-confining layer between the aquifer and the two top layers mentioned.

An approximation is to use Hooghoudt's formula with the expected seepage from below added to the recharge from above. In most cases, the difference in spacing is negligible in practice (less than 5–10 percent). However, there are exceptions, especially where the resistance of the semi-confining layer is low and part of the drainage water passes through the aquifer.

ARTES uses the Bruggeman's method except in the rare cases where this procedure is not convergent or is otherwise doubtful. Then, the Hooghoudt approximation is given, together with a warning.

REFERENCES

- Bruggeman, G.A.** 1999. Analytical solutions of geohydrological problems. *Dev. Wat. Sci.*, 46: 331.
- ILRI.** 2005. *SAHYSMOD, spatial agro-hydro-salinity model*. Version 1.7. Description of principles, user manual and case studies. SAHYSMOD working group of ILRI. Wageningen, The Netherlands. 134 pp.
- Van Drecht, G.** 1983. *Calculation of steady groundwater flow to ditches*. RID-Mededelingen 83-3. In Dutch with English abstract. The Netherlands, National Institute for Water Supply.

Annex 19

Formulae for non-steady-state flow to drains

FLOW ABOVE DRAINS – THE BOUSSINESQ SOLUTION

In 1904, Boussinesq found a solution for non-steady-state (transient) flow to drains lying on an impermeable subsoil layer ($K_2 = 0$), as occurring after heavy rain or irrigation. Boussinesq's equation (Boussinesq, 1904; Guyon, 1966; Moody, 1967) describes the fall in the water table after recharge. Where the initial shape of the groundwater between the drains follows a special curve (nearly an ellipse), it retains this shape during the drainage process because the head diminishes proportionally everywhere. It can be shown that, soon after the end of the recharge event, the shape of the groundwater table becomes almost elliptical, and during its lowering, the curve becomes flatter, but retains its shape (Figure A19.1).

If the soil surface is ponded and the soil profile is completely saturated at the beginning, the theory is not valid for short times. The lowering of the water table reaches the mid-point between drains only after some lag time τ , being the time to approach Boussinesq's pseudo-ellipse, after which a phreatic surface of constant shape is approached. The lag time τ is approximately:

$$\tau \approx \frac{\mu L^2}{CKh_0} \quad (1)$$

where:

$C = 38$, this is an empirical constant derived from numerical experiments;

Z = drain depth (m);

h_0 = initial head midway the drains, equal to drain depth (m);

K = permeability above drain level (m/d);

L = drain spacing (m);

μ = storage coefficient;

τ = lag time (d).

Boussinesq's formula is a solution of the non-linear differential equation:

$$\mu \frac{\partial h}{\partial t} = K \frac{\partial}{\partial x} \left(h \frac{\partial h}{\partial x} \right) \quad (2)$$

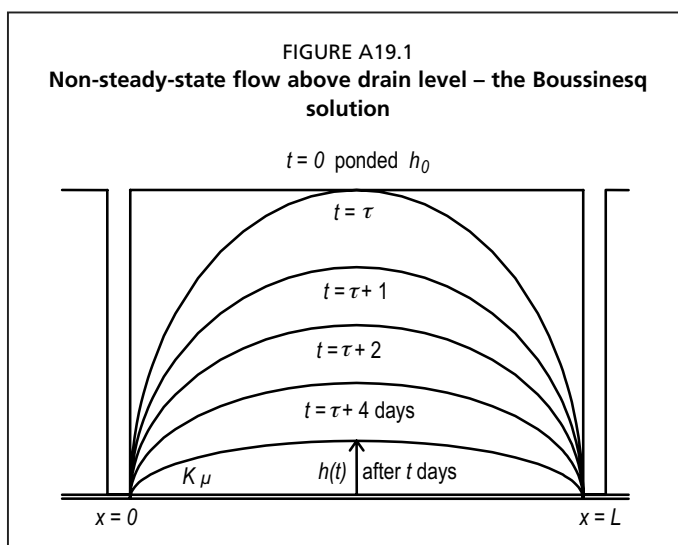

Based on this solution, Guyon proposed the following formula for calculating drain spacing (with $\tau = 0$), valid for Boussinesq's pseudo-ellipse:

$$L^2 = \frac{4.5Kh_0h(t-\tau)}{\mu(h_0-h)} \quad (3)$$

where:

h = hydraulic head midway, at time t (m);

h_0 = initial head midway between drains (at time $t = 0$) (m);

K = soil permeability (m/d);

L = drain spacing (m);

t = time (d);

τ = lag time (d);

μ = storage coefficient.

The factor 4.5 is an approximation of an expression that yields 4.46208...

If the lag time τ has to be considered, the L value may be calculated with the following formula, obtained by combining Equations 1 and 3:

$$L^2 \left[1 + \frac{4.5h}{38(h_0-h)} \right] = \frac{4.5Kh_0t}{\mu(h_0-h)} \quad (4)$$

Equation 4 is the non-steady-state flow equivalent of the steady-state flow ellipse equation. The program NSABOVE, which is based on this equation, describes the flow to drains lying on an impermeable soil layer. The shapes of the water table closely resemble semi-ellipses of decreasing height.

FLOW ABOVE AND BELOW DRAINS – NUMERICAL SOLUTION

Analytical approximations (Glover–Dumm, and Kraijenhoff van de Leur) can be used to calculate drain spacings where $h \ll D_2$. However, these solutions do not consider radial resistance and resistance near the drain. Therefore, numerical methods are preferable because they are easier to handle and are accurate enough for practical purposes. Moreover, evaporation losses, which vary with the depth of the phreatic level and also the effect of outflow restrictions, can readily be incorporated. The latter are caused by the radial resistance concentrated near the drain and the limited capacity of the collecting system.

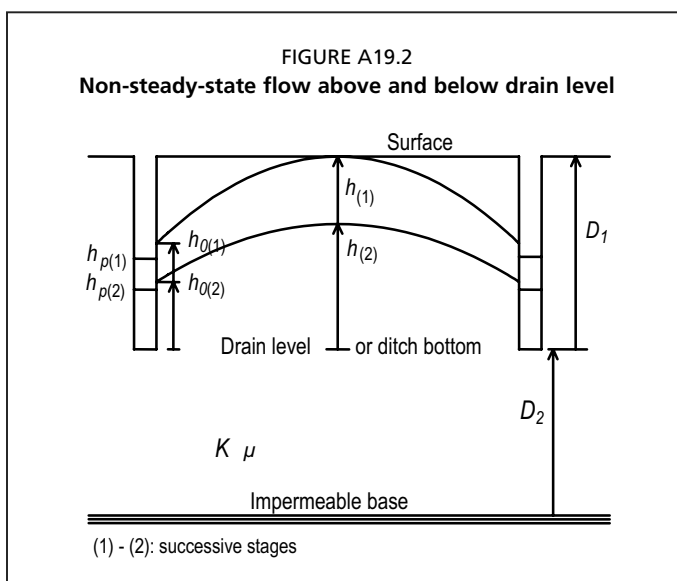

For drains lying above an impermeable soil layer (Figure A19.2), the flow below the drain level must be considered through a layer with a transmissivity KD_2 . The permeability K is the same above and below drain level ($K_1 = K_2 = K$) and D_2 the thickness of the layer below drain level.

After a heavy rain, the water levels in the watercourses and the head in the pipes will be higher than designed. This will in turn restrict the outflow from the soil until equilibrium is reached. In view of the turbulent flow in pipes, their behaviour is supposed to follow a square-root function – at four times the design head, the outflow will be

twice the design discharge. It is further supposed that, at design discharge, no water is standing above the drain ($h_p = 0$).

The outflow is further restricted by the radial and entrance resistance near the drain. This quantity is given as W_r in the program SPACING and here denoted as resistance W . It causes a head loss proportional to the flow.

Evaporation aids in lowering the groundwater, but it decreases rapidly with increasing groundwater depth. For this relationship, there are two options:

- linear reduction to zero at a given groundwater depth;
- exponential reduction with a given “characteristic” groundwater depth where $E = 0.4343E_0$.

These principles form the framework of the programs NSDEPTH and NSHEAD to check calculated drain spacings under non-steady-state flow.

Principle for numerical solution

The principle for numerical solutions is that both time and (horizontal) space are divided into discrete elements and steps. In each element, the water balance during one time-step is:

$$\mu \Delta b \Delta x = (Q_{in} - Q_{out}) \Delta t \quad (5)$$

where:

Q_{in} = flux entering an element, per metre of length (m^2/d);

Q_{out} = flux leaving an element, per metre of length (m^2/d);

x = distance (m);

Δb = fall of groundwater table (m);

Δt = time-step (d);

Δx = distance step (m);

μ = storage coefficient.

To develop this principle into a calculation program, both explicit and implicit methods are possible. The programs use the first approach although the risk of instability requires small time-steps Δt .

Differential equation

For flow below the drain level in the area D_2 (Figure A19.2) and a permeability K being the same above and below drain level ($K_1 = K_2 = K$), Equation 2 becomes:

$$\mu \frac{\partial h}{\partial t} = K \frac{\partial}{\partial x} \left[(h + D_2) \frac{\partial h}{\partial x} \right] \quad (6)$$

where:

D_2 = thickness of layer below drains (m).

The explicit finite difference expression for Equation 6 is:

$$h_{i,j+1} = h_{i,j} + \frac{K \Delta t}{\mu (\Delta x)^2} \left[\left(\frac{h_{i+1,j} + h_{i,j}}{2} + D_2 \right) (h_{i+1,j} - h_{i,j}) - \left(\frac{h_{i,j} + h_{i-1,j}}{2} + D_2 \right) (h_{i,j} - h_{i-1,j}) \right] \quad (7)$$

where:

h = hydraulic head (m);

i = index for distance step;

j = index for time step;

x = distance (m);

Δt = time-step (d);

Δx = distance step (m).

In the model based on this equation, the drain spacing L has been divided into 20 equal parts. Index $i = 0$ represents the left-hand boundary; and $i = 10$ is a plane of

symmetry that forms the right-hand boundary (midway between drains). Therefore, index $i = 11$ is the highest used. In the drainpipe, the head is h_p , near the drain it is h_o .

Boundary conditions

The initial condition ($j = 0$) is a constant head everywhere between the drains (i.e. groundwater at the soil surface):

$$h_{i,0} = h_{mit} \quad i = 1,11 \quad (8)$$

The right-hand boundary condition simulates symmetry at $i = 10$:

$$h_{9,j} = h_{11,j} \quad (9)$$

The left-hand boundary is more complicated. Here, two types of resistance against flow are present:

- a linear resistance W (d/m) against total flow (from both sides), being the sum of the radial resistance (caused by convergence of streamlines near the drain) and entry resistance for flow into the drain;
- a non-linear resistance, caused by the limited capacity of the outflow system (usually the drainpipes). Here, flow is turbulent and proportional to the square root of the available head.

For the one-sided flow q_o (in cubic metres per day per metre of drain) converging towards and entering into the drain:

$$|q_o| = \frac{h_o - h_p}{2W} \quad (10)$$

where (Figure A19.2):

h_o = head near drain (m);

h_p = head in drainpipe (m);

q = flux density to drain (m/d);

$|q_o|$ = flux to drain (absolute value), one-sided (m²/d);

$qL/2$ = flux, one-sided (m²/d);

W = total resistance near drain (radial + entry) (d/m).

For the pipe flow, the outflow system has been designed to discharge a given steady flux density q (in metres per day) at a given head h_{des} (usually the slope multiplied by the pipe length).

For larger discharges, there is a need for an extra head h_p caused by insufficient pipe capacity. Thus, for one-sided flow, originating from width $L/2$:

$$|q_o| = \frac{qL}{2} \sqrt{\frac{h_p + h_{des}}{h_{des}}} \quad \text{if} \quad h_p > 0 \quad (11)$$

where:

h_{des} = design head for outflow system (m).

Finally, for horizontal flow in the first compartment:

$$|q_o| = K \left(\frac{h_1 + h_o}{2} + D_2 \right) \frac{h_1 - h_o}{\Delta x} \quad (12)$$

where:

h_1 = head in first compartment (m).

Equalizing Equations 10–12 yields two equations in the unknown h_o and h_p .

The upper boundary receives a sudden large input at $t = 0$, that saturates the entire soil profile. For $t > 0$, evaporation may help in lowering the water table, but it is dependent on the groundwater depth. Two options are available in the model:

➤ linear decrease with groundwater depth z ;

➤ exponential decrease.

The linear case is characterized by the “critical depth” z_c :

$$E = E_0 \left(1 - \frac{z}{z_c} \right) \quad \text{for } z < z_c \quad (13a)$$

$$E = 0 \quad \text{else} \quad (13b)$$

where:

E = actual evaporation from groundwater (m/d);

E_0 = potential evaporation from groundwater (m/d);

h_{ini} = initial head = drain depth (m);

z_c = critical depth where $E = 0$ (linear model) (m);

z = groundwater depth ($h_{ini} - h$) (m).

The exponential case is characterized by the characteristic depth z_b :

$$E = E_0 e^{-\frac{z}{z_b}} \quad (14)$$

where:

z_b = depth where $E = 0.4343E_0$ (exponential model) (m).

Solution for h_0 and h_p ($W > 0$)

The relation:

$$\frac{h_0 - h_p}{2W} = K \left(\frac{h_1 + h_0}{2} + D_2 \right) \frac{h_1 - h_0}{\Delta x} \quad (15)$$

leads to the quadratic equation:

$$h_0^2 + \left(\frac{\Delta x}{KW} + 2D_2 \right) h_0 - \left(h_1^2 + 2D_2 h_1 + \frac{\Delta x}{KW} h_p \right) = 0 \quad (16)$$

The solution for the head in the drain is:

$$h_0 = -U + \sqrt{U^2 + V} \quad (17a)$$

where:

$$U = \frac{\Delta x}{2KW} + D_2 \quad (17b)$$

$$V = h_1^2 + 2D_2 h_1 + \frac{\Delta x h_p}{KW} \quad (17c)$$

The relation for the head near the drain is found as follows:

$$\frac{h_0 - h_p}{2W} = \frac{qL}{2} \sqrt{\frac{h_p}{h_{des}} + 1} \quad (18)$$

Equation 18 leads to the quadratic equation:

$$h_p^2 - \left(2h_0 + \frac{q^2 L^2 W^2}{h_{des}} \right) h_p + (h_0^2 - q^2 L^2 W^2) = 0 \quad (19)$$

with solution:

$$h_p = h_0 + \frac{q^2 L^2 W^2}{2h_{des}} - qLW \sqrt{\frac{q^2 L^2 W^2}{4h_{des}^2} + \frac{h_0}{h_{des}}} + 1 \quad (20a)$$

$$h_p = \max(h_p, 0) \quad (20b)$$

Iteration starts with Equation 17, with $h_p = 0$ in (17c). The value of h_0 obtained from Equation 17 is used in Equation 20 to find a new h_p value, which is inserted in Equation 17, etc., until convergence is sufficient.

The process is repeated before each time-step. With $h_{1,j} = h_0$ and $h_{2,j} = h_1$ Equation 7 is used to find the new values for the next time-step.

The index F is used as a criterion for stability of explicit numerical calculations:

$$F = \frac{KD'\Delta t}{\mu(\Delta x)^2} \quad (21)$$

where:

$$D' = D_2 + h_0 = \text{maximum initial thickness (m).}$$

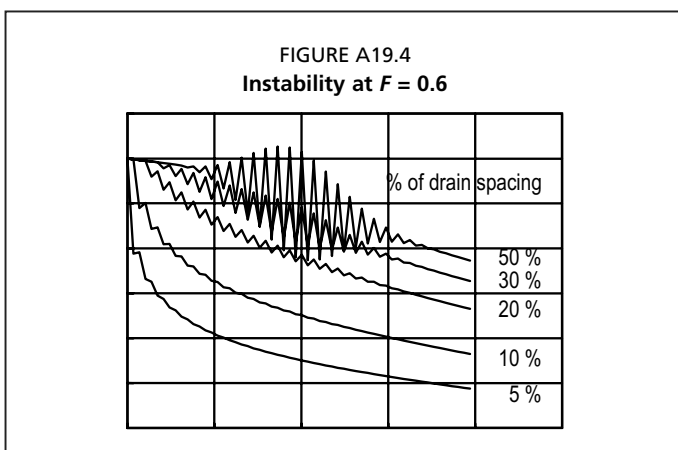
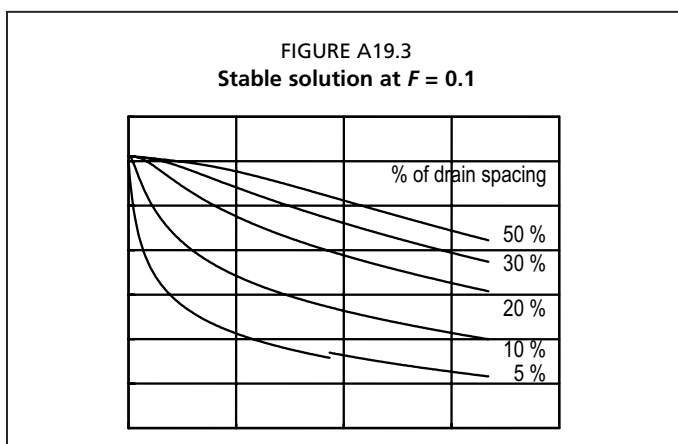

The explicit method is valid for small time-steps and index F only. The characteristic:

$$F = \frac{K}{\mu} \frac{\Delta t}{(\Delta x)^2} (D_2 + h_{mit}) \quad (22)$$

should be less than 0.5 in order to avoid instability (Figure A19.3), and preferably be 0.25 or less (about 0.1) for sufficient accuracy. Figure A19.4 shows an example of instability.

The methods described, for flow above and below drain level through layers with the same K and μ values have been used in the programs NSDEPTH and NSHEAD. These programs check whether the three values for $|q_0|$ from Equations 10, 11 and 12 are indeed equal.

Finally, the water balance is checked. Errors should not exceed 5 percent. If difficulties arise, a smaller time-step is usually helpful.

REFERENCES

- Boussinesq, M.J.** 1904. Recherches théoriques sur l'écoulement des nappes d'eau infiltrées dans le sol et sur le débit des sources. *J. Math. Pures Appl.*, 10 : 1–78.
- Guyon, G.** 1966. Considérations sur le drainage des nappes. Théorie et Experimentation. *Bull. Tech. Gén. Rur.*, 79.
- Moody, W.T.** 1967. Nonlinear differential equation of drain spacing. *J. Irrig. Drain. Div. ASCE*, 92(IR2): 1–9.

Annex 20

Diameters of drainpipes

PRINCIPLES

Drains are collecting systems. Along their length, the discharge and the flow velocity increase gradually. Therefore, the gradient of the hydraulic head is zero at the beginning, and will increase downstream.

Most drains are laid with a certain slope, and this slope is usually taken as a basis for calculating the required diameter. However, not the drain slope, but the total head loss is the basic design parameter.

At the upstream end, the hydraulic head should remain at a certain depth below the soil surface, and this depth determines the available head with respect to the drain outlet, irrespective of the pipe length. The slope is not important, as illustrated in the following example. A drain 200 m long with an outlet 1.50 m below surface and a slope of 0.2 percent, without water standing above the upper end, loses 0.40 m in height along its length. Thus, it will control the upstream water table at a depth of 1.10 m. However, the same will be the case for a horizontal drain (slope zero) of the same length and outlet depth if it loses 0.4 m in head over its length owing to friction.

As an example, at the design discharge intensity q (metres per day – for pipe flow, q is recalculated and expressed in metres per second), the drain is running full at the outlet and the head at the beginning has a design value H (m) above the outlet. The drain itself has a slope, and the slope is such that no water is standing above the drain at its beginning (Figure A20.1). If the slope is less – and also when the drain is horizontal (Figure A20.2) – there is water above the drain at the upper end.

From a hydraulic point of view, the drain is functioning equally well in both cases. Sometimes “self-cleaning” is used as an argument for having the drain slope. However, in

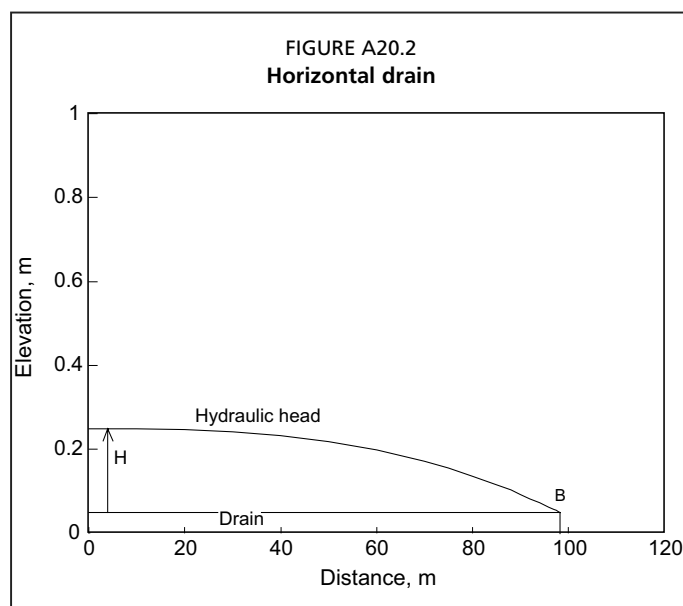
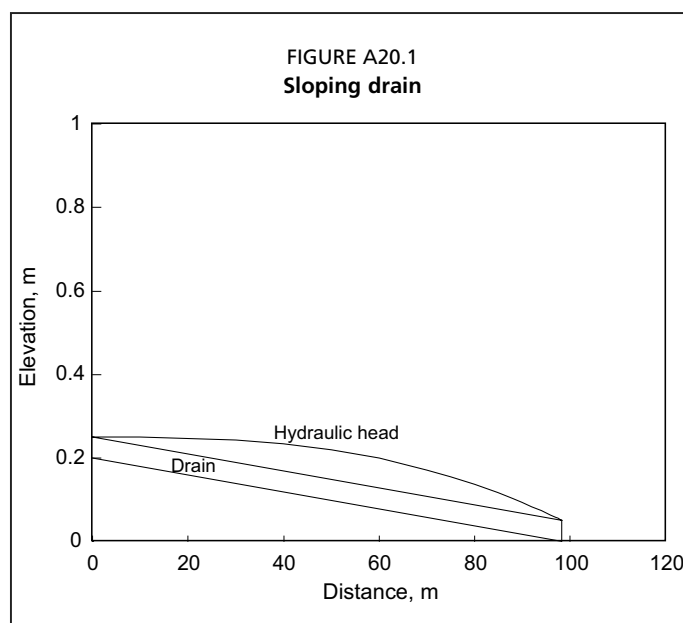

flat lands, drain slopes are seldom more than 0.5 percent and often far less. At such low slopes, the flow velocity is not enough to move sediments.

However, in practice, a slope for the pipe is usually prescribed. Horizontal drains are seldom encountered, except in subirrigation projects where drains are used for discharge in wet seasons and for recharge during droughts.

In the following, the system of Figure A20.1 is considered exclusively. Calculation of the diameter of horizontal drains (Figure A20.2) with formulae for sloping ones (Figure A20.1) sometimes shows small differences, but they are always on the safe side.

The available head loss at design discharge and the amounts of water to be drained under that condition form the basis for calculations concerning required drain diameters. These calculations are based on the laws for pipe flow, which differ for smooth and corrugated pipes.

Both smooth and corrugated pipe drains collect water along their length. As a consequence, the flow is not constant, but it increases gradually from zero at the upstream end to a maximum at the outflow. Introducing this variable Q corresponds with integration of the expressions for laterals and collectors. In laterals, Q increases continuously; in collectors, flow occurs stepwise, namely where the collector is joined by another lateral. However, provisional calculations show that in practice this makes almost no difference, provided that the laterals are of equal length.

SMOOTH PIPES

Non-perforated pipes made of glass, metals, PVC, PE and similar materials may be considered as “hydraulically smooth”. Pipes that are perforated or made of ceramics or cement are “technically smooth”, in which case they obey the same laws, but with a slightly different roughness coefficient. Corrugated pipes are “hydraulically rough”.

Basic equations

For smooth pipes, the Darcy–Weissbach equation is valid:

$$\frac{dh}{dx} = \frac{\lambda v^2}{d 2g} \quad (1)$$

where:

$$\lambda = a \text{Re}^{-0.25} \quad (\text{Blasius}) \quad (2a)$$

$$\text{or } \frac{1}{\sqrt{\lambda}} = \log_{10}(\text{Re} \sqrt{\lambda}) - 0.8 \quad (\text{Nikuradse}) \quad (2b)$$

$$\text{Re} = \frac{vd}{\nu} = 10^6 vd$$

with:

a = coefficient;

d = pipe diameter (m);

g = acceleration of gravity = 9.81 m/s²;

h = hydraulic head (m);

Re = Reynolds' number for pipes;

v = flow velocity (m/s);

x = distance along pipe (m);

λ = coefficient;

ν = kinematic viscosity ($\approx 10^{-6}$ m²/s).

Both expressions for λ give comparable results (Table A20.1, for $a = 0.3164$). Because Equation 2b requires iteration, Equation 2a is normally used.

TABLE A20.1
Comparison between λ -Blasius and λ -Nikuradse

Reynolds' number	λ -Blasius	λ -Nikuradse	% difference
2 000	0.0473	0.0495	4.6
5 000	0.0376	0.0374	-0.6
10 000	0.0316	0.0309	-2.4
20 000	0.0266	0.0259	-2.7
50 000	0.0212	0.0209	-1.2
100 000	0.0178	0.0180	1.1

TABLE A20.2
Values for the a coefficient in Blasius' formula

Type of pipe	a coefficient	Remarks
Smooth, plastic, metal, glazed	0.3164	Non-perforated or well jointed
Technically smooth	0.40	Perforated, cement, ceramics
Corrugated plastic laterals	0.77	Zuidema, from field data ¹

¹ Theoretically not allowed for hydraulically rough pipes, but in accordance with field data for small-diameter corrugated drains.

Completely smooth laterals and collectors do not exist. Smooth plastic pipes contain perforations; ceramic and baked clay ones have joints and are not always aligned. For such “technically smooth” drains and collectors, the a coefficient in Equation 2a was taken as 0.40 instead of 0.3164. Table A20.2 shows values used for the a coefficient, as found in the literature.

Smooth laterals

Drain laterals collect additional water all along their length. At any point x , measured from their upstream end, the discharge Q and the velocity v are:

$$Q = qLx \quad \text{and} \quad v = \frac{4Q}{\pi d^2} = \frac{4qLx}{\pi d^2} \quad (3)$$

where:

- L = drain spacing (m);
- q = design discharge (m/s);
- Q = drain discharge (m³/s).

Accordingly, the flow velocity v varies along the length and so does the Reynolds' number.

Inserting v in the basic equations (Equations 1 and 2a) leads to:

$$\frac{dh}{dx} = \frac{4\sqrt{2}}{\pi^{7/4}} \frac{av^{1/4}(qL)^{7/4}}{gd^{19/4}} x^{7/4} \quad (4)$$

and integrating between $x = B_{i-1}$ and $x = B_i$:

$$\Delta H = \frac{16\sqrt{2}}{11\pi^{7/4}} \frac{av^{1/4}q^{7/4}L^{7/4}(B_i^{11/4} - B_{i-1}^{11/4})}{gd^{19/4}} = F_s(B_i^n - B_{i-1}^n) \quad (5)$$

with:

- B_{i-1}, B_i = begin, end of a drain section (m);
- F_s = calculation coefficient for smooth pipes;
- n = 11/4;
- ΔH = head loss in the drain (m).

In drains consisting of one pipe size only, $B_{i-1} = 0$. However, the full expression will be needed later for drains with increasing pipe diameters downstream (multiple drains). The head loss ΔH in the drain must be less than or at most equal to the design head loss over the entire drain length, H .

If $B_{i-1} = 0$, the permissible drain length B for this design head equals:

$$B = \left(\frac{11\pi^{7/4}}{16\sqrt{2}} \frac{gHd^{19/4}}{av^{1/4} q^{7/4} L^{7/4}} \right)^{4/11} \quad (6)$$

and the minimum diameter required for a given drain length B is:

$$d = \left(\frac{16\sqrt{2}}{11\pi^{7/4}} \frac{av^{1/4} q^{7/4} L^{7/4} B^{11/4}}{gH} \right)^{4/19} \quad (7)$$

The maximum drain spacing allowed at a given diameter amounts to:

$$L = \left(\frac{11\pi^{7/4}}{16\sqrt{2}} \frac{gHd^{19/4}}{av^{1/4} q^{7/4} B^{11/4}} \right)^{4/7} \quad (8)$$

For hydraulically smooth, new, collecting pipes the required head can be calculated with:

$$H = \frac{(qL)^{7/4}}{59.77^{7/4} d^{19/4}} \frac{4}{11} B^{11/4} \quad (9)$$

where conversion of units, physical and mathematical parameters, and integration have caused the numerical constants. An alternative formula for technically smooth pipes is: $Q = 89d^{2.714} s^{0.571}$ (FAO, 2005), where $Q = qLB$ and $s = H/B$. It gives almost the same results as the above formulae with $a = 40$.

In Equations 6–9:

- a = Blasius coefficient;
- B = drain length (m);
- d = inside diameter (m);
- g = acceleration of gravity (m/s^2);
- H = head loss in drain (m);
- L = drain spacing (m);
- q = specific discharge (m/s).

Smooth collectors

Where the laterals are of equal length, the same formulae may be used for designing collectors with added flows at each lateral connection. Now, L_c is the mutual distance between collectors and B_c the length of the collector (L_c is the symbol for collector spacing and B_c for its length. If the laterals are perpendicular to the collectors and the laterals flow from one side only L_c equals their length B . If inflow is from both sides, $L_c = 2B$). For collectors, both are substituted for L and B in the formulae for laterals. The difference from lateral design is that the flow into collectors is discontinuous, in contrast to laterals, where inflow may be considered as continuous along the pipe. However, where more than five laterals are involved, the “discretization error” caused by the inflow of the separate laterals may be ignored in practice.

In the case of unequal lengths of the contributing laterals, the collectors must be calculated section-wise, in which case the discontinuous inflow is accounted for.

CORRUGATED PIPES

Basic equations

Most authors calculate flow through corrugated pipes with Manning's equation:

$$Q = K_m AR^{2/3} s^{1/2} \quad (10)$$

where:

$$A = \pi \left(\frac{d}{2} \right)^2 = \text{area of cross-section (m}^2\text{);}$$

$$K_m = 1/n = \text{Manning coefficient (m}^{1/3}\text{s}^{-1}\text{);}$$

$$R = \frac{A}{u} = \frac{d}{4} = \frac{r}{2} = \text{hydraulic radius (m);}$$

$$s = \text{slope of } H\text{;}$$

$$u = 2\pi \left(\frac{d}{2} \right) = \text{wet circumference (m).}$$

The formula for smooth pipes is sometimes used for corrugated pipes, but with a much larger constant a (Zuidema and Scholten, 1972), whereas other authors (e.g. Van der Beken, 1969, Van der Beken *et al.*, 1972) introduce an equivalent "sand roughness" to account for the influence of the corrugations.

Manning's K_m for corrugated pipes

In Manning's equation, the constant K_m depends mostly on the spacing, depth and shape of the corrugations S and also on the diameter d . The K_m values for corrugated pipes are compiled in Table A20.3. The narrower the corrugation spacing S , the larger K_m . According to Irwin (1984) and Boumans (1986):

$$K_m = 70 \quad \text{for } S < 0.01 \text{ m} \quad (10 \text{ mm}) \quad (11a)$$

$$K_m = 18.7 d^{0.21} S^{-0.38} \quad \text{for } S > 0.01 \text{ m} \quad (10 \text{ mm}) \quad (11b)$$

where:

$$d = \text{inner pipe diameter (m);}$$

$$S = \text{spacing of individual corrugations (m).}$$

Equations 11a and 11b for K_m are used in the programs for corrugated pipes. For safety reasons, the maximum value is taken as 65 instead of 70.

Corrugated laterals

If for full flowing pipes, Equations 3 and 10 are solved for Q :

$$qLx = K_m \frac{\pi}{4} d^2 \left(\frac{d}{2} \right)^{2/3} s^{1/2} = K_m \frac{\pi d^{8/3}}{4^{5/3}} \left(\frac{dh}{dx} \right)^{1/2} \quad (12)$$

The head loss ΔH between points B_1 and B_{i-1} can be obtained by integrating Equation 12 between these points:

$$dh = \frac{4^{10/3} (qL)^2}{\pi^2 K_m^2 d^{16/3}} x^2 dx \quad (13)$$

TABLE A20.3
 K_m values for corrugated pipes

Country	Material	Drain diameter d		Rib spacing S (mm)	K_m value
		Outer	Inner		
		(mm)			
Netherlands	PVC	65	57	6.25	70
		80	72	6.25	74
		100	91	6.25	78
		160	148	7.50	80
Germany	PVC	60	52	6.30	69
		100	91	8.30	70
		125	115	8.30	73
		380	307	50.00	46
United States of America	PE	129	100	18.00	53
		196	171	20.00	57
United Kingdom	PP	265	225	33.00	50
		350	305	50.00	45

$$\Delta H = \frac{4^{10/3} (qL)^2 (B_i^3 - B_{i-1}^3)}{3\pi^2 K_m^2 d^{16/3}} = F_c (B_i^n - B_{i-1}^n) \quad \text{with } n=3 \quad (14)$$

with:

F_c = calculation coefficient for corrugated pipes.

As mentioned above, in drains consisting of one pipe size only $B_{i-1} = 0$. For corrugated pipes, integration of Manning's equation results in:

$$H = \frac{4^{10/3} (qL)^2 B^3}{3\pi^2 K_m^2 d^{16/3}} \quad (15)$$

For corrugated pipes with small corrugations an alternative formula is (FAO, 2005): $Q = 38d^{2.667} s^{0.5}$. For corrugated pipes with a diameter of more than 200 mm and large corrugations an alternative formula is (FAO, 2005): $Q = 27d^{2.667} s^{0.5}$. Both give almost the same results as those mentioned in the text.

Where the design head H is given, and $B_{i-1} = 0$, the other values (e.g. d or L) are readily derived from Equation 15. Thus, the permissible length B is:

$$B = \left(\frac{3\pi^2 K_m^2 d^{16/3} H}{4^{10/3} (qL)^2} \right)^{1/3} \quad (16)$$

Corrugated collectors

If the collectors have the same spacing L_c , the same formulae may be used for their calculation, substituting their spacing L_c and length B_c for L and B . If they do not have the same spacing, calculations have to be made separately for each section of the collector. The spacing of laterals, and, thus, the distances of inflow points along the collector, has only little effect, provided that more than five laterals are involved.

MAINTENANCE STATUS AND REDUCTION FACTORS

The problem of clogging of drainpipes

In practice, drains are seldom completely clean. This is because some siltation always occurs, notably during and shortly after construction owing to the entrance of soil particles from the yet unsettled soil and/or envelope around the pipe when relatively large amounts of water enter. A layer of sediment usually forms over time. This

sediment should be removed by maintenance, where it reduces the transport capacity of the pipe too much. Siltation may be also caused by other materials, e.g. iron oxides. Moreover, plant roots as well as certain animals may enter into drainpipes and hamper their proper functioning. Detailed information about the problem of clogging of pipes and envelopes is given in FAO (2005).

Siltation differs greatly from place to place and even in the same drainpipe. In particular, sunks in the alignment of the pipe cause siltation problems. Therefore, drain installation design and construction practices should take care to avoid the presence of such vulnerable stretches.

Entry of soil and plant roots can be prevented largely by a good envelope around the drains, by construction at sufficient depth, or by using non-perforated pipes for the stretch that crosses under a row of trees. However, for clogging by chemical precipitates, such as iron, this is not the case.

In addition to the effectiveness and durability of the drain envelope, the clogging of drains is connected with cleaning operations and their frequency. Drainpipe maintenance frequency depends on soil conditions and other circumstances. It is hardly needed for well-constructed drains surrounded by a stable soil or by an envelope and without iron precipitation phenomena, whereas in others deterioration is rapid. The latter is often the case under artesian seepage, which often induces ochre deposition, and in acid sulphate soils (cat clay soils and cat sands), where precipitation of iron compounds is also common.

Therefore, the design usually allows for a certain amount of clogging, which depends on the geohydrological and soil conditions at drain level and on the anticipated frequency of inspection and cleaning.

Maintenance status

To take account of the aspects described above, the “maintenance status” is used as a parameter in the programs for calculating drain diameters. As mentioned above, maintenance status is a combination of:

- local circumstances (envelope materials, soils, ochre formation, etc);
- maintenance operations (frequency, intensity, availability of adequate equipment, etc).

Maintenance status has little to do with a specified rate of cleaning, but it is an indication of the state of cleanliness in which the drains can be kept under the given conditions. Under certain conditions, almost no maintenance is needed to realize a “good” maintenance status. This is the case with well-constructed drains in stable soil layers. In other conditions, much effort is required to keep it “fair”, as is the case with unstable silt soils and where iron clogging is a severe problem.

This means that under an expected “poor” maintenance status even frequent cleaning is not sufficient. Hence, larger diameter pipes should be used than under an “excellent” status. Therefore, a reduction should be applied to the described formulae, by multiplying K_m with a correction factor f (e.g. $f = 0.8$).

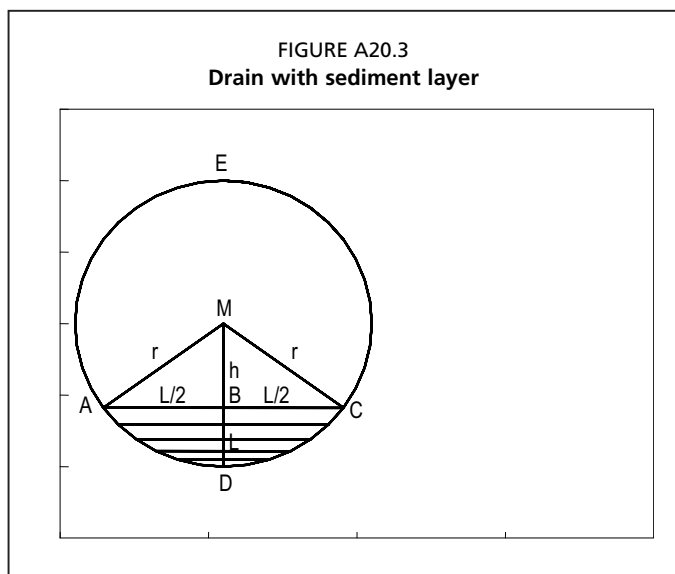

Manning's K_m for drains with sediments

Figure A20.3 shows a drain $AECD$, with radius r , which is partly filled with sediment $ABCD$. The thickness of this layer BD is l , and the distance BM from the centre M is h .

For a clean pipe, Manning's formula can be written as:

$$Q = K_m A (r/2)^{2/3} s^{1/2} \quad (17)$$

A correction for the sediment layer is obtained as follows.

The angle $\angle AMC$ is φ , so $\angle AMB = \angle BMC = \varphi/2$.

The thickness of the layer is:

$$l = r - h = r \left[1 - \cos \frac{\varphi}{2} \right] \quad \text{and} \quad \varphi = 2 \arccos(1 - l/r) \quad (18)$$

The area available for water flow A' is:

$$A' = \pi r^2 - \left(\varphi \frac{r^2}{2} - h \frac{L}{2} \right) = \pi r^2 - \left(\varphi \frac{r^2}{2} - r^2 \sin \frac{\varphi}{2} \cos \frac{\varphi}{2} \right) = r^2 \left(\pi + \frac{\sin \varphi}{2} - \frac{\varphi}{2} \right) \quad (19)$$

where the angle φ is expressed in radians.

Thus, the reduction factor for diminished area (A' instead of A) is:

$$f_1 = \frac{A'}{A} = \frac{r^2 \left(\pi + \frac{\sin \varphi}{2} - \frac{\varphi}{2} \right)}{\pi r^2} = 1 - \frac{\varphi - \sin \varphi}{2\pi} \quad (20)$$

The hydraulic radius was $R = r/2$ and becomes:

$$R' = \frac{r \left[\pi + \frac{\sin \varphi}{2} - \frac{\varphi}{2} \right]}{2 \sin \frac{\varphi}{2} + 2\pi - \varphi} \quad (21)$$

Thus, the reduction factor for R is:

$$f_2 = \frac{R'}{R} = \frac{2\pi + \sin \varphi - \varphi}{2 \sin \frac{\varphi}{2} + 2\pi - \varphi} \quad (22)$$

Therefore, the drain discharge is reduced to:

$$Q' = K_m f_1 A (f_2 r/2)^{2/3} s^{1/2} = K'_m A (r/2)^{2/3} s^{1/2} \quad (23)$$

The correction factor for K_m is:

$$f = f_1 f_2^{2/3} \quad \text{and} \quad K'_m = f K_m \quad (24)$$

Table A20.4 shows the f values calculated for different fractions of sediment height and area. These values are represented in Figure A20.4.

Categories according to maintenance status

For the reasons discussed above, maintenance can only be specified in a global way. From the data in Table A20.4, the following choices were made with respect to maintenance status by distinguishing five categories. These categories have been defined in terms of the relative height of sediments in the drainpipes (Table A20.5). Table A20.5 shows the influence of maintenance status on the flow in partially clogged drains.

The maintenance status should be envisaged in the design stage. As only a rough classification is possible, the categories in Table A20.5 have been distinguished, for which the corresponding f values have been used in the programs. For these maintenance groups, the f factors will be used in the programs for drainpipe design. The f values are valid for Manning's equation. To avoid unnecessary complications, the programs also use these values in the Darcy–Weissbach approach for smooth pipes. The K_m values are multiplied by f to obtain “corrected” values K'_m , and the coefficients a must be divided by f^2 to obtain “corrected” values for a_c :

$$a_c = \frac{a}{f^2} \quad (25)$$

ZUIDEMA'S METHOD FOR CORRUGATED LATERALS

From numerous observations on existing corrugated laterals, Zuidema and Scholten (1972) found good agreement with Blasius' formula where a larger a coefficient was taken. They recommended using the value $a = 0.77$ for these pipes. This method is included as an option in the programs. It appears that the results obtained in this way are similar to or slightly more conservative than those for Manning's equation with “narrow rib spacing” (in the programs $K_m = 65$) and with a correction factor $f = 0.923$, corresponding to “good maintenance”.

DRAIN LINES WITH INCREASING DIAMETERS

The above considerations refer to drains composed of one pipe diameter only. Long laterals and collectors usually require pipes of successively larger dimensions. Because of the rapid increase in prices with size, it often pays to replace the upstream part of the

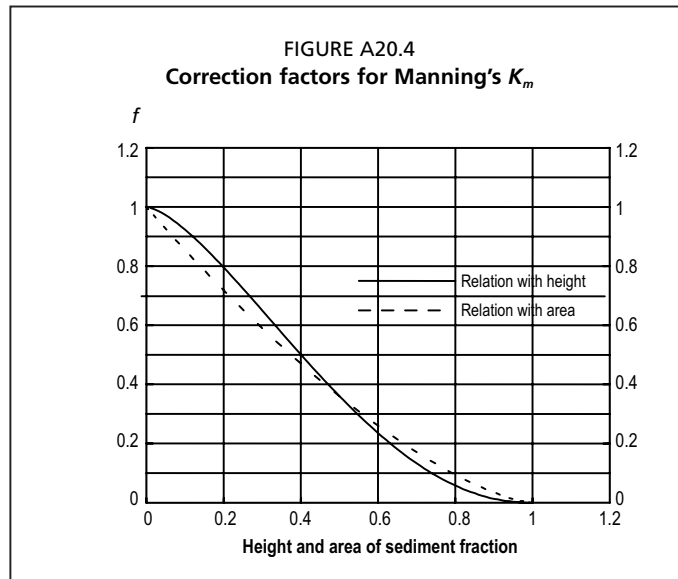
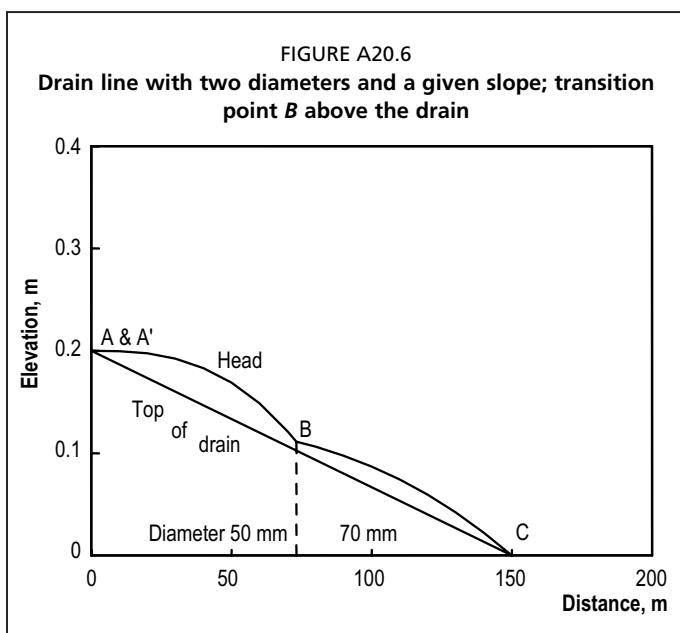
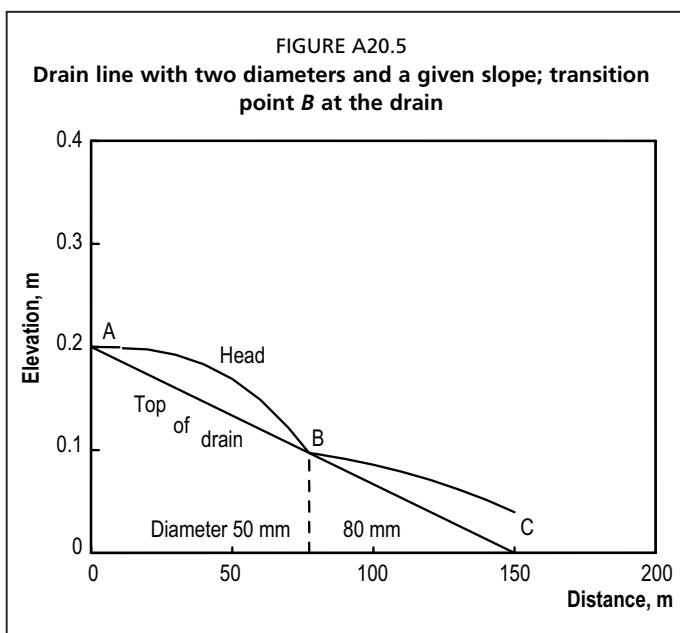

TABLE A20.4
Correction factor f for pipes with sediment

Fraction of sediment height $l/2r$	Fraction of sediment area $1 - A'/A$	Factors		
		f_1	f_2	f
.050	.019	.981	.986	.972
.100	.052	.948	.961	.923
.150	.094	.906	.930	.863
.200	.142	.858	.894	.796
.250	.196	.804	.854	.724
.300	.252	.748	.810	.650
.350	.312	.688	.764	.575
.400	.374	.626	.715	.501
.450	.436	.564	.664	.429
.500	.500	.500	.611	.360
.550	.564	.436	.556	.295
.600	.626	.374	.500	.235
.650	.688	.312	.441	.181
.700	.748	.252	.382	.133
.800	.858	.142	.259	.058
.850	.906	.094	.196	.032
.900	.948	.052	.131	.013
.950	.981	.019	.066	.003
.990	.998	.002	.013	.000

TABLE A20.5
Flow reduction in partially clogged drains

Maintenance status	Cross-section clogged (%)	Reduction factor for flow f
New pipe	0	1.000
Excellent	5	0.972
Good	10	0.923
Fair	20	0.796
Poor	40	0.501



In the programs, attention has been given to these aspects.

Given slope

It is supposed that the drain slope equals $s = H_i/B_i$, so that – at design discharge – there is no water above the upper end of the drain (Figure A20.5).

The first section AB has a length B_1 , governed on the one hand by Equation 5 or 14; on the other, by the given slope. From the latter, it follows that the head loss in this section equals:

$$\Delta H_1 = H \frac{B_1}{B} \quad (26)$$

where H is the design head.

system – where the flows are still small – by a section of smaller size pipe, and use gradually larger ones downstream. The following sections consider drains of two sizes.

Effect of drain slope

Where a multiple drain is running full and slopes over the entire head (“full slope”), the head at the transition cannot fall below the top of the drain at that point. This is illustrated by Figure A20.5, where the transition point B lies at the top of the drain.

In Figure A20.5, it may be observed that drain AC , with given slope ($0.20/150$ m/m) consists of 50-mm and 80-mm pipes. B is a critical point determined by the head loss in the first section. The drain is running full and the head is not allowed to fall below the top of the drain. At C , some head is still available. Thus, the system is not very efficient. The consequence is that the drain has excess capacity and that the available head is not used entirely for water transport. The outlet at C could even be “drowned” to satisfy the design head at point A .

Figure A20.6 gives an example where this is not the case, because the transition point B lies above the drain and the full available head is used.

Drain AC , with given slope, consists of 50-mm and 70-mm pipes. B is not critical and the hydraulic grade line lies above the drain, at the intersection of the curves AB and BC . No extra head is available at C .

Inserting ΔH_1 in Equation 5 or 14, with $B_0 = 0$ (first section), and rearranging, leads to:

$$B_1 = \left(\frac{H}{F_1 B} \right)^m \quad (27)$$

For smooth pipes, $F_1 = F_s$ with $d = d_1$ and $m = 4/7$; for corrugated pipes, $F_1 = F_c$ with $d = d_1$ and $m = 1/2$

If B_1 exceeds the total length B , the first section is already sufficient to meet the requirements. In this case, a combination with narrower pipes might be used.

The second section, with diameter d_2 , causes a head loss ΔH_2 , for smooth drains according to Equation 5, for corrugated pipes to Equation 14. The factors F_s or F_c are now calculated with $d = d_2$.

The total head loss $\Delta H_t = \Delta H_1 + \Delta H_2$ must be smaller than or at most equal to the required H . If greater, a second section with larger diameter must be chosen or another combination be tried.

Hydraulic heads along the drain

The available head along the drain depends on the distance x from the beginning. In the programs, they are expressed as head above outlet level. Thus:

$$H_x = H - \Delta H_i \quad i = 1, 2 \quad (28)$$

For the first section, where $x \leq B_1$, H_x is calculated from:

$$H_x = H - \Delta H_1 = H - F_1 x^n \quad (29)$$

and for the second, where $x > B_1$:

$$H_x = H - \Delta H_1 - \Delta H_2 = H - (F_1 - F_2) B_1^n - F_2 x^n \quad (30)$$

For smooth pipes:

$$F_1 = F_s \text{ with } d = d_1 \text{ and } n = 101/4;$$

$$F_2 = F_s \text{ with } d = d_2 \text{ and } n = 11/4.$$

For corrugated pipes:

$$F_1 = F_c \text{ with } d = d_1 \text{ and } n = 3;$$

$$F_2 = F_c \text{ with } d = d_2 \text{ and } n = 3.$$

The considerations given above form the basis of the program DRSINGLE for the design of smooth and corrugated laterals and collectors consisting of one section. For two or more sections with different diameters and also of different types, the program DRMULTI can be used. Figure A20.7 shows a longitudinal profile along such a drain. At the upstream end, no water is standing above the drain, and at the outlet downstream there is still some head available. This indicates that the proposed combination is sufficient to carry the design discharge.

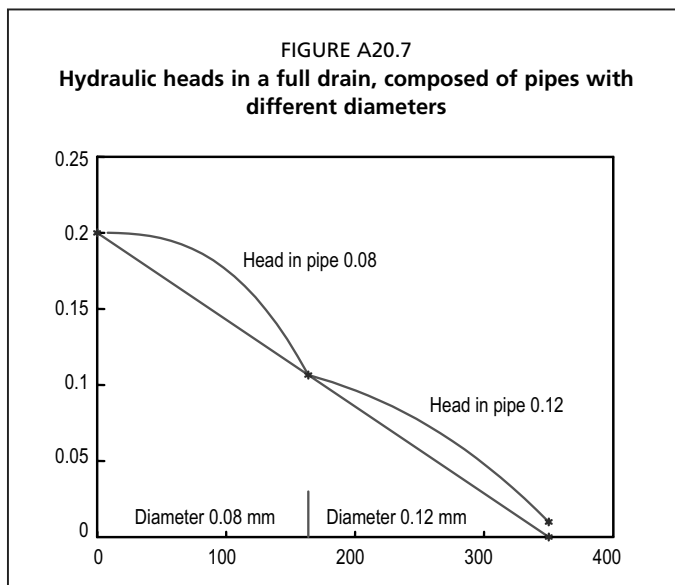

REFERENCES

- Boumans, J.H.** 1986. Stromingsformules voor drainage ribbelbuis. *Cultuurtech. Tijdschr.*, 26: 41–46.
- FAO.** 2005. *Materials for subsurface land drainage systems*, by L.C.P.M. Stuyt, W. Diericks & J. Martínez Beltrán. FAO Irrigation and Drainage Paper No. 60 Rev. 1. Rome. 183 pp.
- Irwin, R.W.** 1984. Corrugated pipe flow rate from pipe geometry. *J. Irr. Dr. Eng.*, 237–241.
- Van der Beken, A.** 1969. Bijdrage tot de hydraulica van draineerbuizen. *Meded. Rijk. Landbouww. Publ.*, 35/WB-5. 87 pp.
- Van der Beken, A, De Troch, F, De Somer, M. & Zuidema, F.C.** 1972. The lateral inflow into submerged drains. *Bull. Int. Ass. Hydrol. Sci.*, 17: 273–289.
- Zuidema, F.C. & Scholten J.** 1972. De afvoercapaciteit van geribbelde plastieken draineerbuizen. *Van Zee tot Land*, 49: 73–102.

Annex 21

Interceptor drains

FLOW FROM SURROUNDINGS

Inflow from higher places and from leaky irrigation canals can sometimes be captured by interceptor drains, especially where it passes through relatively shallow aquifers. Such drains can take the form of pipes or open ditches. In the latter, the stability of the side slopes is often problematic if large amounts are to be captured. Better solutions are gravel-filled trenches provided with a suitable pipe of sufficient capacity to carry the discharge.

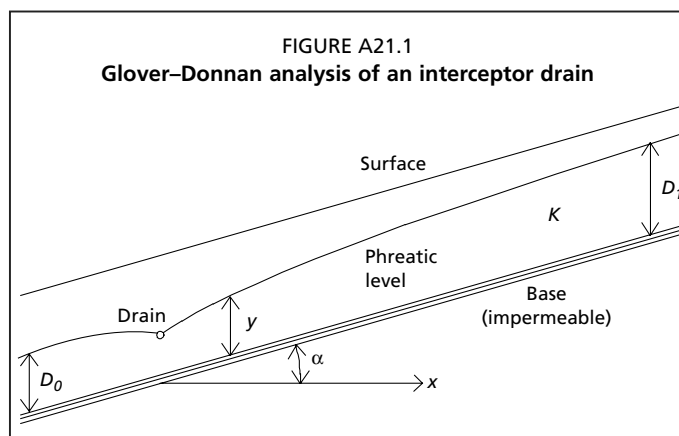

HILLSIDES

An analysis of the interception of flow from hillsides of uniform slope was given by Donnan (1959), as represented in Figure A21.1.

The flow from upstream, per metre of length, is:

$$q_1 = KD_1 \operatorname{tg} \alpha \quad (1)$$

and downstream:

$$q_0 = KD_0 \operatorname{tg} \alpha \quad (2)$$

The drain discharges, per metre of length, is:

$$q = q_1 - q_0 \quad (3)$$

where:

q_1 = upstream flow per metre of length (m^2/d);

q_0 = downstream flow per metre of length (m^2/d);

K = permeability (m/d);

D_1 = upstream thickness of flow (m);

D_0 = downstream thickness (m);

α = angle of slope (rad).

In this analysis, the downstream flow has a thickness D_0 , which is entirely governed by the distance of the drain above the impermeable base (which is governed by the drain depth).

The upstream thickness varies from D_0 near the drain to D_1 far upstream. A given thickness y appears at a distance x from the drain:

$$x = \frac{1}{\operatorname{tg} \alpha} \left[D_1 \ln \frac{D_1 - D_0}{D_1 - y} - (y - D_0) \right] \quad D_0 < y < D_1 \quad (4)$$

where:

x = distance from drain (upstream) (m).

On hill slopes, hydrological conditions are often much more complicated. Wet or saline spots caused by seepage may sometimes be protected by an interception drain laid at the upper end of the affected field.

This formula ignores the radial resistance encountered in the convergence of the stream lines onto the drain. Because of this resistance, D_0 has to be increased, with the resulting head Δh .

In a homogeneous soil, this radial resistance can be estimated by Ernst's formula:

$$W_r = \frac{1}{\pi K} \ln \frac{2D_0}{\pi d} \quad (5)$$

and

$$h_r = (q_1 - q_0) W_r \quad (6)$$

where:

d = effective diameter of drain (m);

W_r = radial resistance (d/m);

h_r = extra head from radial resistance (m).

In the described case of a homogeneous soil and a constant angle α , this increase in D_0 will usually be slight. However in the cases described below, the consequences can be considerable.

In most cases, an interceptor drain will be laid if: the slope decreases, the depth of the impermeable base becomes less, or the permeability decreases. At places where these occur, hillside flows tends to come too close to the surface and cause waterlogging, eventually followed by soil salinization. Based on the above theory, the program INCEP gives the required effective diameter of the drain, necessary to diminish the radial resistance to a sufficiently low level. It is valid for a non-layered soil (Figure A21.2), and allows jumps in thickness and permeability at the drain. The arithmetic averages of thickness and permeability are used in order to calculate the radial resistance.

The capacity of pipes for interceptor drains must be calculated separately from the discharge per metre, their length and their longitudinal slope. The programs

DRSINGLE and DRMULTI can be used for this purpose. The largest value from both calculations (for effective diameter and for capacity) must be taken.

Conditions become far worse where the drain cannot reach well-permeable subsoil and remains within a less permeable top layer, a case covered by program INCEP2. Then h_r soon reaches such high values that a single interceptor drain is not sufficient, and a wide ditch or even regular drainage is needed.

The program INCEP2 supposes that the drain trench or open ditch has a flat bottom that is located in the topsoil and receives the flow from the permeable subsoil (Figure A21.3). In

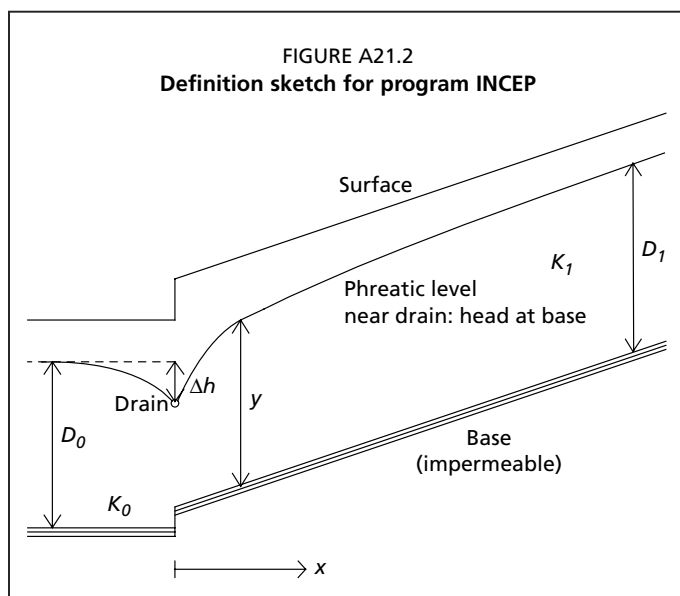

this case, the exact solution can be found by complex transformation. An excellent approximation for this case is obtained by calculating the parallel lines flow between the border with the permeable subsoil and the ditch bottom with Equation 7, using a correction factor of 0.88.

$$b = a \left(\frac{q}{K_1 \Delta h} - 0.88 \right) \quad \text{for } b/2 > a \quad (7)$$

where:

a = distance to more permeable subsoil ($K_1 < 0.1K_2$) (m);

b = width of drain trench or ditch bottom (m);

K_1 = permeability of topsoil (m/d);

K_2 = permeability of subsoil ($K_2 > 10 K_1$) (m/d);

q = upward flow (m²/d);

Δh = difference in piezometric head above the trench bottom (m).

INCEP2 provides both solutions for b .

LEAKY CANALS AND UPSTREAM FIELDS

The same principles apply for interceptor drains catching leakage from irrigation canals of losses from upstream fields.

For leaky irrigation canals, the best way is to reduce the water losses by lining. Where that is impossible, and damage is occurring by nearby waterlogging or salinization, interceptor drains are a second option. Then, the incoming flow per metre, q_1 , is half of the losses from the canal. These losses can be estimated by measuring the fall in water level in an isolated section.

However, these losses are proportional to the difference in head between the canal water and the nearby groundwater. Therefore, drainage will increase both head and inflow (Figure A21.4). Lowering the groundwater increases the flow with a factor h_2/h_1 .

The incoming inflow can be calculated if the original loss and the factor h_2/h_1 and q_0 are determined:

$$q_1 = q_0 (h_2 / h_1) \quad (8)$$

where:

q_0 = original outflow from canal (m²/d);

q_1 = outflow from canal after interceptor drainage (m²/d);

D = thickness of aquifer (m);

h_1 = hydraulic head in the canal (m) above original groundwater level;

h_2 = hydraulic head in the canal (m) above drain level.

On the other hand, losses from upstream irrigated or rainfed lands will not be influenced by interceptor

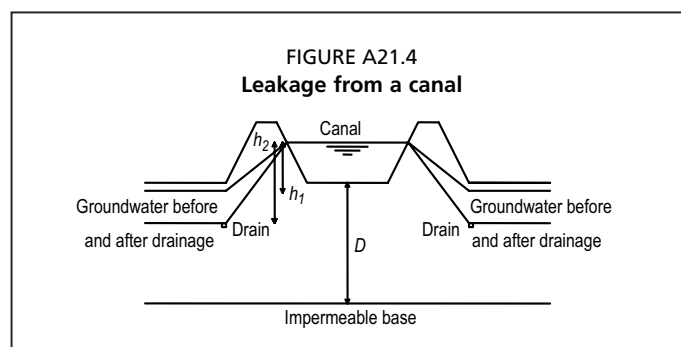
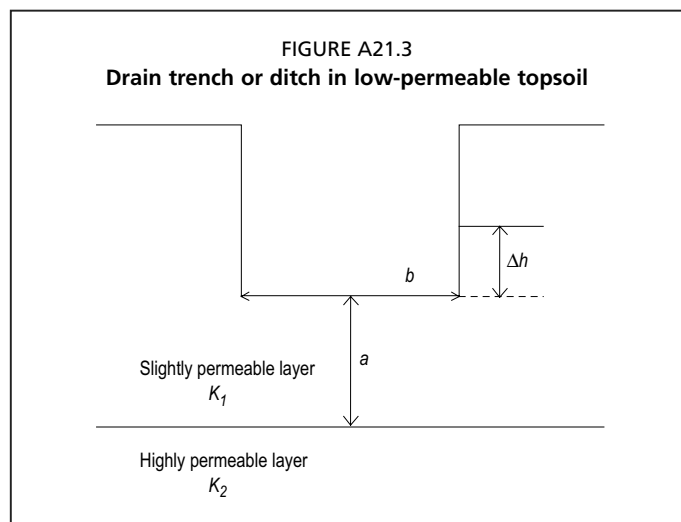

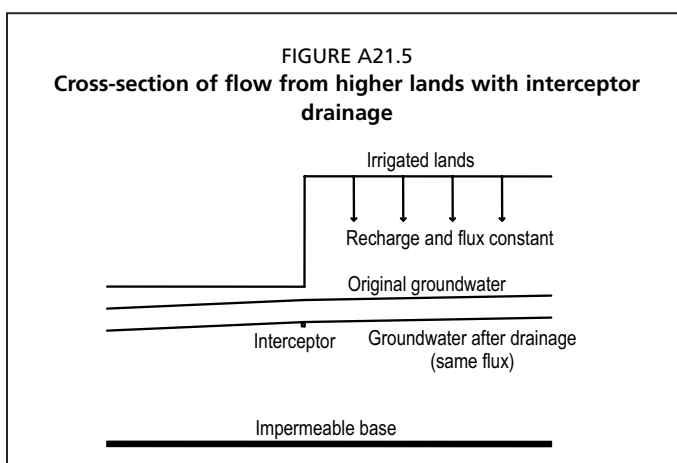

drainage. This is because these losses are a component of the upstream water balance, as can be observed from the cross-section shown in Figure A21.5.

These types of losses can be estimated from water balances or by applying Darcy's Law to the resulting groundwater current.

Where the canal or field losses are known, the programs INCEP and INCEP2 can be used to find the necessary trench width for the interceptor drain.

RESULTS

In many cases, the width is such that a regular drainage is to be preferred, for which the program ARTES gives some guidelines. Alternatively, a wide ditch can be considered, especially at intermediate values for the required width. However, as side slopes tend to become unstable under such circumstances, it is often necessary to stabilize them. This can be achieved by covering the side slopes with a gravel cover or by making a wide, gravel-filled trench provided with an outlet pipe.

REFERENCE

Donnan, W.W. 1959. Drainage of agricultural lands using interceptor lines. *J. Irri. Drain. Div. Proc. ASAE*, 85, IR 1:13-23.

Annex 22

Drainage by vertical wells

INTRODUCTION

“Vertical drainage” is possible under favourable geological circumstances:

- a good aquifer underneath;
- an aquifer containing water with a low salt content, so that the water can be used;
- not too large resistance between soil and aquifer.

Figure A22.1 gives a sketch of the method.

Two types of wells are considered: those fully penetrating the aquifer; and non-penetrating “cavity” wells. They are supposed to form a large array of squares (Figure A22.2) or triangles (Figure A22.3). In Figures A22.2 and A22.3, for one well, the flow region and the sphere of influence are indicated.

This method is mainly used in arid regions where use of the water for irrigation has often led to serious overpumping. In some areas, the lowering of the water levels in the aquifer has led to attraction of salty water from elsewhere, often from deeper layers, sometimes from the sea. In the long run, in an arid climate, salt will inevitably accumulate. However, this process is usually very slow, owing to the large amount of water stored in an aquifer. Thus, vertical drainage may be a temporary solution to a high water table situation.

Nevertheless, the method can be used to control groundwater levels. This is illustrated by the following (steady-state) theory.

FULLY PENETRATING WELLS

An area is drained by an array of evenly spaced deep wells tapping an aquifer (Figure A22.1). This array may be quadratic or triangular and contains a large number of wells that penetrate the entire aquifer. Each of them drains an equivalent

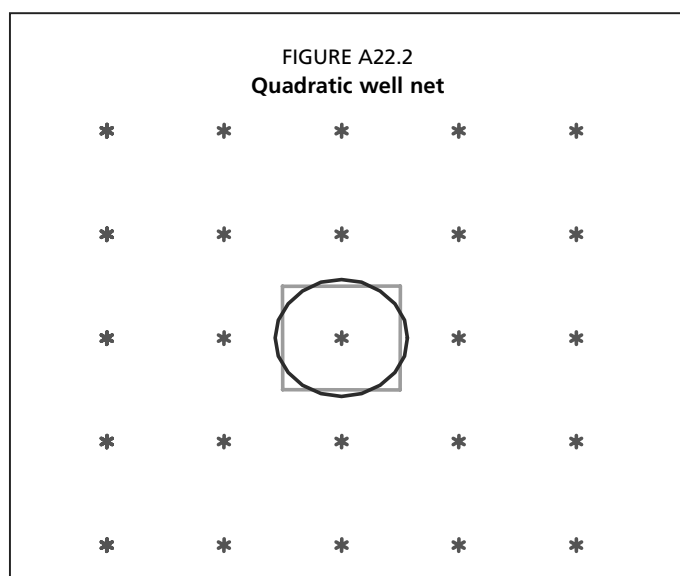
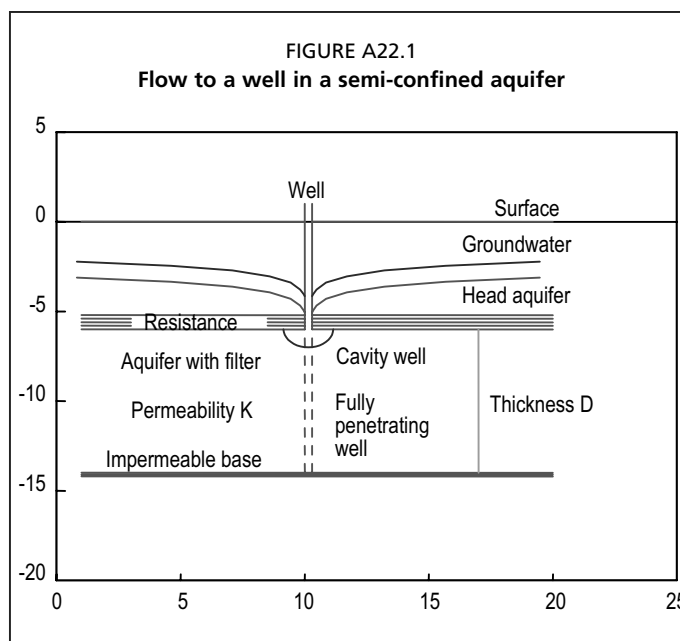

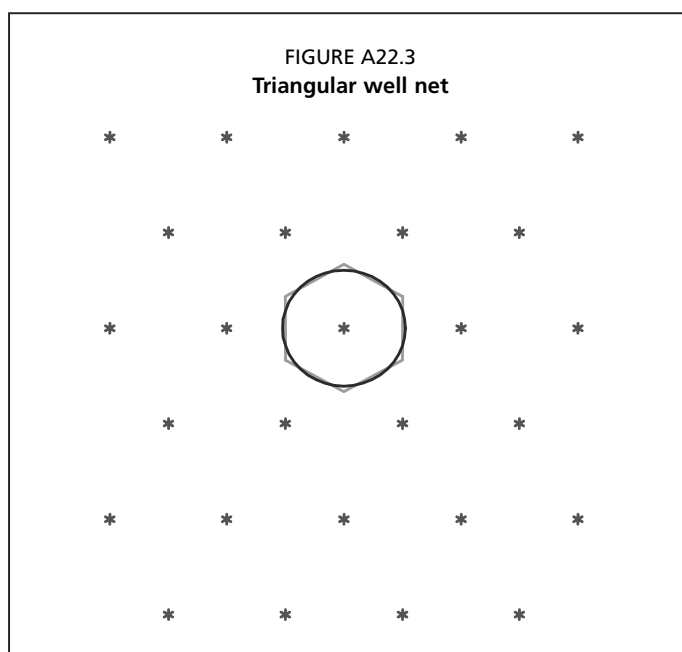

square (Figure A22.2) or a hexagon (Figure A22.3), depending on the array pattern (quadratic or triangular, respectively). This outer limit is approached by a circle of equal area, with radius R , and the flow is cylindrical towards the well. The entire well-field is very large and exchange of water with the surroundings may be ignored. Recharge is from the surface.

The aquifer is overlain by a relatively thin layer of low permeability, which separates it from the shallow phreatic water. It offers a certain resistance to flow between groundwater and aquifer, but does not prevent it entirely. Thus, pumping lowers not only the hydraulic head in the aquifer, but also the shallow groundwater level.

The aquifer has a permeability K (metres per day) and a thickness D (metres), and, thus, a transmissivity $T = KD$.

Between the aquifer and the groundwater is a semi-permeable layer of low vertical permeability K' and thickness d' . This leads to a certain resistance $c = d'/K'$, which is considered independent of the water levels. If K' is in metres per day and d' in metres, c is in days.

Through this layer, the aquifer is recharged by rainfall or irrigation, with an intensity q (metres per day).

A first estimate about the square spacing of wells is that it should be of the order of a characteristic length of the aquifer system:

$$\lambda = \sqrt{K D c} \quad (1)$$

where:

$$c = \frac{d'}{K'} = \text{resistance of semi-confining layer (d);}$$

D = thickness of aquifer (m);

d' = thickness of semi-confining layer (m);

K = permeability of aquifer (m/d);

K' = permeability of semi-confining layer (m/d);

λ = characteristic length (m).

Greater insight is obtained from formulae describing the lowering of the groundwater when an aquifer is pumped by a network of wells under the following conditions (Figure A22.1):

- the wells are fully penetrating and tap the aquifer over its entire depth;
- between groundwater and aquifer, there is a layer of low permeability that gives a certain resistance to vertical flow, but still allows its passage;
- there is equilibrium between the amounts pumped and the recharge (steady state);
- no water is entering the well-field laterally from outside.

The yield of each well Q_w is taken to be positive, as is the flow Q towards the well. According to Darcy's Law and taking absolute values for Q , for the flow in the aquifer:

$$|Q| = 2\pi rKD \frac{dH}{dr} \quad (2)$$

On the other hand, the rainfall or irrigation excess should create the same flow:

$$|Q| = \pi(R^2 - r^2)q \quad (3)$$

so that both expressions for Q are equal, provided that there is no lateral inflow from around the well-field.

Finally, the vertical resistance c of the layer between groundwater and aquifer leads to a recharge:

$$q = \frac{b(r) - H(r)}{c} \quad (4)$$

where, in these equations:

b = groundwater level (m);

H = head in aquifer (m);

q = recharge (m/d);

$|Q|$ = flow towards well, absolute value (m³/d);

Q_w = discharge of well, absolute value (m³/d);

r = distance from well centre (m);

r_w = radius of well (m);

R = radius sphere of influence of well (m);

in which Q , b and H are functions of r .

At the watershed boundary with other wells, $r = R$ and $Q = 0$. At this critical point, b should have a prescribed maximum level. If b and H are expressed with respect to soil surface, the groundwater should be at a certain depth (e.g. 2.0 m), so that $b(R) = -2.0$. Then, with a given recharge q and resistance c , $H(R)$ can be calculated from Equation 4.

Then, it follows from the basic equations that:

$$2\pi KD r \frac{dH}{dr} = \pi q (R^2 - r^2) \quad \text{or} \quad dH = \left(\frac{qR^2}{2KD} - \frac{qr^2}{2KD} \right) \frac{dr}{r} \quad (5)$$

Integration gives for the head H in the aquifer:

$$H(r) = H(R) - \frac{qR^2}{2KD} (\ln R - \ln r) + \frac{q}{4KD} (R^2 - r^2) \quad (6)$$

R is taken as the radius of a circle with the same area as the quadrangular or triangular region served by one well.

Under these conditions, the following equation is valid for the groundwater height b :

$$b = H - qc \quad \text{for} \quad r_w \leq r \leq R \quad (7)$$

Midway between the surrounding wells, the groundwater table should be lowered to the required depth, but it will be deeper near the well. The head in the aquifer is lower than the groundwater level because of the resistance between the two. If more water is being pumped than the recharge, there will be overpumping, leading to a gradual depletion of the aquifer. Although this is usually not sustainable, overpumping can be

a temporary solution for water scarcity (“groundwater mining”), high groundwater tables, and soil salinization.

For a quadratic pattern (Figure A22.2) with well spacing distances L , the area A served per well is:

$$A = L^2 = \pi R^2 \quad \text{or} \quad R = \frac{L}{\sqrt{\pi}} = 0.564L \quad (8)$$

For a triangular array (Figure A22.3), the region drained by a well is hexagonal, where:

$$A = \frac{1}{2} L^2 \sqrt{3} = \pi R^2 \quad \text{or} \quad R = \frac{L\sqrt{3}}{\sqrt{2\pi}} = 0.525L \quad (9)$$

CAVITY WELLS

In some areas, wells are made by removing sand from the aquifer by heavy pumping. A washed-out cavity is formed at the top of the aquifer, which remains intact during the following period of less heavy abstraction (Figure A22.1, in blue). Compared with fully penetrating wells, they encounter an extra resistance, but their diameter is larger, although the actual size is rarely known.

The cavity is supposed to be a half-sphere with radius r_w . In its vicinity, the flow is spherical and an extra resistance occurs. This effect is estimated by assuming that the flow to such non-penetrating wells breaks down as follows:

- cylindrical flow from the outer limit R to a distance r_d from the well, so that Equation 6 can be used for $r > r_d$; arbitrarily, r_d can be taken as the lowest value of D or R ;
 - spherical flow from distance r_d to the spherical cavity with radius r_w .
- For r_d , arbitrarily:

$$r_d = D \quad (10)$$

where:

D = thickness of aquifer (m);
and $D < R$.

For very thick aquifers or a very dense network, D can become larger than R . Then, for $D > R$:

$$r_d = R \quad (11)$$

The cylindrical part of the flow is described by Equation 6 for $r_d < r \leq R$.

The head in the aquifer is calculated (or approximated) by:

$$H(r) = H(r_d) - \frac{qR^2}{2K} \left(\frac{1}{r} - \frac{1}{r_d} \right) + \frac{q}{2K} (r_d - r) \quad r_w \leq r \leq r_d \quad (12)$$

There are several assumptions involved, but the greatest uncertainty lies in the unknown diameter (thus, radius r_w) of the cavity. Although this is an approximation, the errors are small enough for practical purposes.

APPLICABILITY OF THE METHOD

If more water is being pumped than the recharge, there will be overpumping, leading to a depletion of the aquifer. Moreover, an equilibrium abstraction will also not be sustainable in an arid region. This is because its use for irrigation will lead ultimately to a harmful accumulation of salt in the aquifer. However, both overpumping and equilibrium abstraction may be used as temporary solutions for water scarcity, high

groundwater, and soil salinity. The time horizon depends on the local circumstances and requires further study.

The program WELLS is based on these considerations. The differences between fully penetrating and cavity wells relate to an extra radial resistance in the vicinity of the latter (red and blue lines in Figure A22.1). This extra resistance is caused by flow to a sphere instead of a long cylinder.

Annex 23

Computer programs for drainage calculations

GENERAL CONSIDERATIONS

The programs first mention their name and purpose. Then, the following three questions appear:

Notation of decimals

The use of the decimal separator in your country, point or comma, is requested. Answer 1, 2 or 9. If a comma, a warning is given to ENTER all decimal data with a point as separator. Using a comma would lead to serious errors. Answer the question with 9 if you like to quit.

Project name

A project, or a section of it, must be indicated by a name of at most four characters, which will form part of the output filename. The limited length allowed is because of the limited size of filenames under DOS.

Certain rules must be followed:

- The program asks for a project name, put between single quotation marks. A maximum of four characters are allowed between those quotes, so that abbreviations are often needed (e.g. 'proj' for project). It is advisable to divide large projects into sections and use section names (usually one or two characters) as the project name. The single quotes indicate that the name is entered as a character string, even if it is a pure number ('23').
- Project names with less than four characters are padded with minus signs in order to obtain filenames of equal length. Thus, 'A2' automatically becomes 'A2--'.
- When the session is finished and the program closed, the data are saved in a file. The filename has two characters indicating the kind of program, followed by this project name and the extension TXT, for example, file SPA2--.TXT for program drain spacings (SP) with project name entered as 'A2'.
- However, as new data become available, this existing file cannot be used again, because this project name is already occupied. If tried, a warning is given that the name is already in use and that a new name must be given. Thus, it is advisable to end with a number, so that (for example) project 'A2' can be followed later by 'A3', where both cover the same area 'A'.

Location

After this short indication for the project (or part of it), the program asks for the location within. Each project file can store observations from different locations, which are indicated by a name of at most ten characters (letters and numbers).

Again, the name must be between single quotation marks. The location can be a plot number ('123', 'C14'), a name ('Johnson', 'Bahawalpur'), or a combination ('7aq2n4').

If processed in the same session, the data for several locations within the same project are combined into one file, which contains the name of the project (A2---.TXT in the earlier example). This project file contains all locations treated and is closed automatically at the end of the session. As mentioned above, the name cannot be used again.

All project files obtained are listed in a file LIST**, beginning with LIST, followed by two characters for its kind (LISTSP.TXT contains all drain spacing [SP] calculations made).

Output files

For each project, the results are written to a file, the name of which is mentioned by the program.

If reading in DOS, take care to copy this indication literally, including the signs -, --, and --- used if some of the four positions are blanks (project 'A' leads to file A---.TXT, and project 'AB' to file AB--.TXT).

Under Microsoft Windows, this difficulty is avoided. Just double-click the icon.

GUMBEL'S METHOD

GUMBEL, for estimating extreme values

After the three general questions (notation of decimal, project name, and location), the program moves on to specifics:

- Input of the extreme values (e.g. the highest three-day precipitation in a given month, in millimetres) from keyboard or from data file. They are processed using Kendall's method.
- The return period (T) related to hydrological data (usually in years). The program gives the expected values.
- End the series of T with 999. A graph appears on screen with the data on the vertical axis, and the Gumbel distribution on the horizontal, with the data plotted according to Kendall. The Kendall line is shown in red. The graph is useful to visually detect upward or downward trends, which make the prediction less valid and indicate that the method may not be applicable in this case: too low if upward, too high if downward.
- Leave the graph with ENTER.

Continuation, output and example

The process can be repeated in a new case belonging to the same project. With another project or END, the files are closed and the results written to file GU****.txt, where GU stands for "Gumbel" and **** is the abbreviated project name. These filenames are mentioned in LISTGU.TXT.

Figure A23.1 gives the output for extremes of total precipitation occurring during 1 to 7 successive days (1d to 7d) in an area in eastern Spain. The climate is Mediterranean, with heavy rainfall in autumn.

PERMEABILITY MEASUREMENTS

AUGHOLE, for permeability from auger-hole measurements

After the three general questions (notation of decimal, project name, and location), the program moves on to specifics:

- Which unit is chosen? Answer 1, 2 or 3. Recommended is 2, the use of centimetres, in contrast to most other programs.
- Diameter and depth of the auger hole in the chosen units?
- Location of the impermeable base?
- Groundwater present or no? This determines the method: normal or inverse (less reliable).

Normal method

For the "normal" method, the initial depth of the water in the hole is measured after equilibrium. Then, some water is pumped out and the position of the water table is given at different times:

- Equilibrium groundwater depth?
- Water depth at time t_1 ?
- Water depth at time t_2 ? (should be less).
- Time interval $t_2 - t_1$ in seconds?

Inverse method

In dry soils, the groundwater may be too deep to measure the permeability of the upper layers. In this case, the inverse method can be used. Water is poured in, and its lowering is measured over time. The method is less reliable and should be used only if there is no other possibility. Moreover, some soils swell slowly and have a lower permeability in the wet season.

Option “no groundwater” is followed, and the fall of the water level and the time interval are entered.

Continuation

The resulting permeability appears on screen.

Next items:

- Same or new auger hole or END? The first option allows another measurement in the same auger hole, e.g. in the subsequent interval. The other two finish the calculation and show the mean value and its standard deviation on screen.
- The next item can be in the same project or not. In the first case, the existing project file is continued. Otherwise, it is closed and the filename mentioned on screen as AU****.txt where AU denotes “auger hole” and **** is the abbreviated project name.
- This name is also added to the listing LISTAU.TXT, mentioning all existing auger-hole files.
- If “Other project or END” is selected, new names are required for project and location; “END” returns the user to the initial screen.

FIGURE A23.1
Printout of program GUMBEL

```

***** Gumbel Distribution *****
=====
project: Pego; location: P-1d; case: Pego01.txt
return period value
  2.0  111.3565
  5.0  188.6375
 10.0  239.8043
 20.0  288.8846

***** Gumbel Distribution *****
=====
project: Pego; location: P-2d; case: Pego02.txt
return period value
  2.0  136.6437
  5.0  232.8728
 10.0  296.5849
 20.0  357.6990

***** Gumbel Distribution *****
=====
project: Pego; location: P-3d; case: Pego03.txt
return period value

***** Gumbel Distribution *****
=====
project: Pego; location: P-4d; case: Pego04.txt
return period value
  2.0  162.4361
  5.0  273.7000
 10.0  347.3664
 20.0  418.0289

***** Gumbel Distribution *****
=====
project: Pego; location: P-5d; case: Pego05.txt
return period value
  2.0  171.9708
  5.0  283.2239
 10.0  356.8832
 20.0  427.5389

***** Gumbel Distribution *****
=====
project: Pego; location: P-6d; case: Pego06.txt
return period value
  2.0  177.9110
  5.0  284.9797
 10.0  355.8684
 20.0  423.8667

***** Gumbel Distribution *****
=====
project: Pego; location: P-7d; case: Pego07.txt
return period value
  2.0  186.2486
  5.0  291.2184
 10.0  360.7175
 20.0  427.3827

```

FIGURE A23.2
Printout of program AUGHOLE

```

***** Calculation of K from auger hole data *****
=====
project: OFL1; location: Swifterb; case: OFL101.txt

diameter depth groundwater depth of position of
cm      cm      depth cm      base cm      hole bottom
-----
8.0    150.0   50.0   200.0   above base
-----
number water level cm      time      K      stand.err.
meas.  1      2      s      m/d      of mean
--- direct method -----
1      85.0   83.0   20.0   .63
2      80.0   78.0   24.0   .60
3      70.0   68.0   31.0   .67
-----
                        mean .63 .02

```

Example

In the project OFL1, at location Swifterb, an auger hole of 8 cm in diameter and 150 cm deep is made. The impermeable base is at a depth of 200 cm. Groundwater establishes a water level in the hole at a depth of 50 cm. Several measurements are taken after lowering to 90 cm below the surface. This gives $K = 0.63$ m/d, as shown by Figure A23.2.

PIEZOM, for permeability from piezometer measurements

After the three general questions (notation of decimal, project name, and location), the program moves on to specifics:

- Which unit is chosen? Answer 1, 2, or 3. Recommended is 2, the use of centimetres, in contrast to most other programs.
- Diameters of protection pipe and cavity in the chosen units?
- Length of protection pipe and cavity in the chosen units?
- Location of the impermeable base?
- Equilibrium groundwater depth below top of pipe?

Then, some water is pumped out and the position of the water table is given at different times:

- Water depth at time t_1 ?
- Water depth at time t_2 ? (should be less).
- Time interval $t_2 - t_1$ in seconds?

The “inverse method” is not included.

Continuation

The resulting permeability appears on screen.

Next items:

- Same or new piezometer hole or END? The first option allows another measurement in the same piezometer, e.g. in the subsequent interval. The other two finish the calculation and show the mean value and its standard deviation on screen.
- The next item can be in the same project or not. In the first case, the existing project file is continued. Otherwise, it is closed, and the filename mentioned on screen as PZ****.TXT where PZ indicates “piezometer” and **** is the abbreviated project name.
- This name is also added to the listing LISTPZ.TXT, mentioning all existing piezometer files.
- If “Other project” is selected, new names are required for project and location. “END” returns the user to the initial screen.

Output

The output is similar to that of AUGHOLE. Figure A23.3 gives an example.

CALCULATION OF DRAIN SPACINGS**SPACING, for drainage under “normal” (non-artesian) conditions**

After the three general questions (notation of decimal, project name, and location), the program moves on to specifics:

- How is the size of drains expressed, (as diameter, as radius, as width of open ditches)? ENTER 1, 2 or 3.
- The size itself, in metres? Divide centimetres by 100 and always use a point for the decimal.
- The design discharge, in metres per day. Divide millimetres per day by 1 000.
- The required groundwater depth at this recharge, in metres below surface.
- The depth of drains (pipes or ditch bottoms), in metres below surface.

These general data appear on screen. If correct, ENTER 1; else 9 to restart the questions. Then:

- The number of layers distinguished: the first above drain level, the remaining strata below.
- Their thickness. That of the first is known, being the drain depth; for the others, it must be given.
- Their anisotropy. As this will seldom be available, it is advisable to use 1 above drain level, and below 4 if not clearly layered and 16 if so. This is a better guess than neglecting anisotropy.
- Their permeability, as measured by auger hole or piezometer or estimated from profile characteristics.

The soil data are shown and, if correct, the necessary calculations are made.

Continuation

The project can be continued and then the data for the new location are added to the same file. If a new project is taken or the existing one is ended, the files are closed and the filename is mentioned on screen and added to LISTSP.TXT. Any new project needs another name.

Output and example

The results are visible on screen and put on file SP***.TXT, where SP denotes “spacing” and *** the abbreviated project name. Figure A23.4 gives an example of the output for project ‘aa’, location ‘amandabad’. The radial resistance W_r can be used as input in the programs NSDEPTH and NSHEAD.

FIGURE A23.3
Printout of program PIEZOM

```

***** Calculation of K from piezometer data *****
=====
project:d; location: da nang; case: d--01.txt
=====
Piezometer
diameter   length   groundw. position
pipe cavity pipe cavity depth  bottom
cm         cm         cm         cm         cm         cavity
-----
8.0   5.0   200.0   25.0   40.0   above base
-----
number water  depth cm  time   K  stand.err.
meas.  1      2      s      m/d  of mean
-----
  1    120.0  115.0  12.0  3.29
  2    115.0  110.0  13.0  3.25
-----
                        mean 3.27 .02

```

FIGURE A23.4
Printout of program SPACING

```

*****Drain spacings, steady state*****
Artesian influences not significant
=====
project: aa; location: amandabad; case: aa--01.txt
***** GENERAL INPUT DATA for SPACING *****
effective diameter of drain      .08 m
design discharge of drain         .015 m/d
design groundwater depth midway  .30 m
design head above drain level     1.20 m
design drain depth                1.50 m
*****
***** Soil data *****
thickness layer 1, above drains  1.50 m
thickness layer 2, below drains  2.00 m
anisotropy factor layer 1       1.00 --
anisotropy factor layer 2       4.00 --
horiz. permeability layer 1     1.00 m/d
horiz. permeability layer 2     2.00 m/d
-----
Results -----
available head                   1.20 m
radial resistance Wr              .97 d/m
flow above drains/total flow     .20 --
drain spacing L-Hooghoudt       43. m
*****

```

NSABOVE, for drain spacing at non-steady flow above drain level only

After the three general questions (notation of decimal, project name, and location), the program moves on to specifics:

- Thickness of permeable layer (equal to drain depth or ditch bottom).
- Pipe drains or ditches. For pipes and dry and almost dry ditches, the Boussinesq approach is followed; for water-holding ditches, the Schilfgaard method is used.
- For pipe drains and nearly dry ditches, there is choice between an “elliptic” initial situation, where the shallowest depth is midway between drains, or a total ponding of the entire area.
- In the elliptic case, the initial groundwater depth midway is asked (in ponding it is zero everywhere). In the Schilfgaard method, the shape is initially elliptic.
- The required groundwater depth at time t and the value of t .
- For water-holding ditches, the (constant) water depth must be specified.
- If these data are correct, the soil characteristics are required: the permeability and the available storage (moisture volume fraction between saturation and field capacity).
- Calculations are made and the resulting drain spacing appears on screen.
- If initially ponded, a “lag time” is mentioned, an estimation of the time span between total saturation and the first lowering midway between drains.

FIGURE A23.5
Printout of program NSABOVE

```

***** Non-steady flow above drain or ditch bottom *****
=====
project: a; location: a1; case: a--01.txt
***** Drains *****
drain depth          1.40 m
depth impermeable base  1.40 m

Properties of permeable layer
permeability (horiz.=vert.)  2.00 m/d
storage coefficient          .12 --

----- Results -----
groundw.depth      at t= .00 d      .00 m [everywhere]
groundw.depth midway at t= 1.00 d    .20 m
drain spacing . . . . . L      19. m
estimated lag time          .41 d
*****

***** Non-steady flow above drain or ditch bottom *****
=====
project: a; location: a2; case: a--02.txt

***** Ditches Schilfgaard *****
ditch water depth below surface  .80 m
ditch bottom depth below surface  1.40 m
depth impermeable base          1.40 m

Properties of permeable layer
permeability (horiz.=vert.)      2.00 m/d
storage coefficient              .12 --

----- Results -----
groundw. depth midway at t= .00 d    .00 m [elliptic]
groundw. depth midway at t= 1.00 d    .20 m
ditch spacing . . L-Schilfgaard     22. m
estimated lag time                .00 d
*****

```

Continuation

The process can be repeated in a new case belonging to the same project. With another project or END, the files are closed and the results written to file NA****.txt, where NA stands for “Nonsteady Above” and **** is the abbreviated project name. These filenames are mentioned in LISTNA.TXT.

Output and examples

Figure A23.5 gives results at two locations in project ‘a’, of which location ‘a1’ has pipe drains, location ‘a2’ water-holding ditches. In the first case, the surface is considered ponded at the beginning; in the second case, the water table is initially elliptic. The difference in “lag time” to reach a nearly elliptic shape explains most of the difference in drain spacing.

NSDEPTH and NSHEAD, for drains above impermeable base

NSDEPTH gives the depth of the groundwater below surface, NSHEAD gives the head above drain level.

After the three general questions (notation of decimal, project name, and location), the programs move on to specifics:

- The permeability (equal above and below drain level), in metres per day.
- The storage coefficient, as volume fraction.
- The drain depth, in metres below surface.
- The thickness of the layer below the drains, in metres.
- The initial groundwater depth, the same everywhere: ponded or specified. If ponded, it is automatically zero; if specified, the initial depth is required.
- The radial resistance W_r near the drain (d/m). An estimate can be obtained from the program SPACING. The entrance resistance, met by flow into the drain, is ignored. For ditches, it is near zero; for good working drains, it is negligible, of the order of 0.1 d/m.

For abnormally high discharges, the outflow system can be handled by the pipes and ditches, but at higher heads and water levels. The following data allow an estimate:

- The design discharge of the outflow system, in metres per day. Divide millimetres per day by 1 000.
- The design head loss in this system, in metres. At high discharges, higher head losses are to be expected, leading to higher levels in this system.

After a heavy rain (or snowmelt), evaporation may help to lower the groundwater tables, but the influence diminishes the deeper they are. The following items allow an estimate:

- The potential evaporation, in metres per day. Divide millimetres per day by 1 000.
- The relationship of potential evaporation with groundwater depth, linear or exponential.
- The depth where evaporation becomes zero (linear) or the characteristic depth where it is reduced to $1/e$ times the value at the surface (exponential).

Check the input. If correct, continue with:

- Proposed drain spacing, in metres.
- Number of days to be calculated.
- Time-step for the calculation (lower than a given maximum), in days.

NSDEPTH shows the resulting groundwater depths on screen, with t is the time, d_p the groundwater level in the drainpipe, d_0 the groundwater level near the drain and d_1 – d_{10} the depths between the drain and midway, where d_0 is drain and d_{10} is midway. Finally, d_{11} is equal to d_0 (symmetry).

If unsatisfactory, other drain spacing can be taken. A slow retreat in d_p values suggests an insufficient main system or unsatisfactory performance of the drainpipe. Large differences between d_p and d_0 indicate a considerable influence of the radial resistance W_r .

NSHEAD is similar, but it gives the heads above drain level instead of the depths.

Continuation

After ending with 999, the process can be repeated for a new case belonging to the same project. With another project or END, the files are closed and the results written to file ND****.txt or NH****.txt, where ND stands for “Nonsteady Depth”, NH for “Nonsteady Head” and **** is the abbreviated project name. These filenames are mentioned in LISTND.TXT and LISTNH.txt.

Output and examples

Figure A23.6 and A23.7 show examples from NSDEPTH and NSHEAD for project aa, location aa1. The first shows the groundwater depths as function of time, the second the heads above drain level. Together they form the drain depth of 1.50 m. The initial depth of the water table was 0.2 m below surface, giving the initial head as 1.30 m.

FIGURE A23.6
Printout of program NSDEPTH

```

***** Non-steady flow, groundwater depths *****
=====
project: aa; location: aa1; case: aa--01.txt

***** GENERAL INPUT DATA for NSDEPTH ****
soil permeability          2.000 m/d
storage coefficient        .150 ---
drain depth below surface  1.500 m
thickness soil below drain level  2.000 m
initial groundw. depth below surface .200 m
radial resistance Wr       .500 d/m
outflow system, design capacity .0100 m/d
outflow system, design head .500 m
max. evaporation          .0050 m/d
groundwater depth where E=.43E0 .500 m
*****

**** Results of NSDEPTH, non-steady depth ****

***** Depths below soil surface *****
t=time, dp=depth in drain, d0=outside drain
d10=midway, d0-d11=proportional distances from drain

Drain spacing L  20.00 m
Radial resistance Wr .50 d/m

  t  dp  d0  d1  d2  d3  d4  d5  d6  d7  d8  d9  d10  d11
.00 .39 .21 .20 .20 .20 .20 .20 .20 .20 .20 .20 .20 .20
.15 .47 .29 .26 .25 .23 .22 .22 .22 .21 .21 .22 .22 .22
.30 .50 .33 .30 .28 .26 .25 .24 .23 .23 .23 .22 .22 .22
.45 .53 .36 .33 .31 .29 .28 .26 .25 .25 .24 .24 .24 .24
.60 .55 .38 .36 .33 .31 .30 .28 .27 .27 .26 .26 .26 .26
.75 .58 .41 .38 .36 .34 .32 .31 .29 .29 .28 .28 .28 .28
.90 .60 .43 .40 .38 .36 .34 .33 .32 .31 .30 .30 .30 .30
1.05 .62 .45 .42 .40 .38 .36 .35 .34 .33 .32 .32 .32 .32
1.20 .64 .47 .44 .42 .40 .38 .37 .36 .35 .34 .34 .34 .34
1.35 .66 .49 .47 .44 .42 .40 .39 .38 .37 .36 .36 .36 .36
1.50 .67 .51 .49 .46 .44 .42 .41 .40 .39 .38 .38 .38 .38
1.65 .69 .53 .51 .48 .46 .44 .43 .42 .41 .40 .40 .40 .40
1.80 .71 .55 .52 .50 .48 .46 .45 .44 .43 .42 .42 .42 .42
1.95 .73 .57 .54 .52 .50 .48 .47 .46 .45 .44 .44 .43 .44
2.10 .75 .59 .56 .54 .52 .50 .49 .48 .47 .46 .46 .45 .46
2.25 .77 .61 .58 .56 .54 .52 .51 .49 .48 .48 .47 .47 .47
2.40 .78 .63 .60 .58 .56 .54 .52 .51 .50 .50 .49 .49 .49
2.55 .80 .65 .62 .60 .58 .56 .54 .53 .52 .52 .51 .51 .51
2.70 .82 .66 .64 .61 .59 .58 .56 .55 .54 .53 .53 .53 .53
2.85 .83 .68 .66 .63 .61 .59 .58 .57 .56 .55 .55 .55 .55
3.00 .85 .70 .67 .65 .63 .61 .60 .59 .58 .57 .57 .56 .57

```

ARTES, for drainage under artesian conditions

After the three general questions (notation of decimal, project name, and location), the conditions are mentioned and the program moves on to specifics:

- How is the size of drains expressed (as diameter, as radius, as width of open ditches)?
- The size itself, in metres? Divide centimetres by 100 and always use a point for the decimal.
- The design discharge, in metres per day. Divide millimetres per day by 1 000.
- The required groundwater depth at this recharge, in metres.
- The required groundwater depth if there is no recharge (important for salinization in times that there is no irrigation and no rainfall). This depth must be greater than the former.
- The depth of drains (pipes or ditch bottoms), in metres below surface.

These general data appear on screen. If correct, ENTER 1, else 9 to restart the questions.

Then, data are required about soils and hydrology:

- The thickness of the top layer of low permeability, above and below drain level. Above, it is already given by the drain depth and mentioned as such. Below, it must be entered or estimated. However, where the thickness below is only a few decimetres, it is better to put the drains somewhat deeper, so that they tap the underlying aquifer. This avoids many problems with seepage.

- The anisotropy above and below drain level. Often this is unknown. If not visually layered, put 1 above and 4 below, else 16 below.
- The horizontal permeability above and below, in metres per day, as can be measured by auger hole or piezometer.
- The resistance between top layer and aquifer, in days. This is thickness divided by permeability of the layer between top layer and aquifer. A minimum is 25–50 days, a thin layer of tight clay has already 1 000–5 000 days. If unknown and no clay or compressed peat interferes, input 200 or try several values to see the effect.

- The hydraulic head in the aquifer in metres, above drain depth in cases that upward seepage occurs. For negative seepage (natural drainage), input negative values.

These data appear on screen. ENTER 1 if correct, 9 otherwise. If correct, the necessary calculations are made.

Continuation

The project can be continued and then the data for the new location are added to the same file. If a new project is taken or the existing one is ended, the files are closed and the filename is mentioned on screen and added to LISTAR.TXT. Any new project needs another name.

Output and example

The results are visible on screen and put on file AR****.TXT, where AR denotes “artesian” and **** the abbreviated project name. The smallest drain spacing is critical and should be taken. The filename is mentioned on screen and added to LISTAR.TXT.

As an example, Figure A23.8 describes a seepage area under irrigation in project ‘a’, location ‘adana’. If irrigated, downward water movement causes removal of salts, but if no irrigation is given the situation is critical, because of upward movements. Therefore, the drain spacing should not exceed 17 m, the smallest spacing given.

WELLS, for vertical drainage

Vertical drainage requires special conditions and is seldom a durable solution as it usually leads to overpumping and mobilization of salts from elsewhere. However, if required, a first estimate for well spacings can be obtained, based on steady-state equilibrium.

The program starts with the three general questions (notation of decimal, project name, and location) and then moves on to specifics:

- The minimum groundwater depth at the points furthest from the wells.
- The type of well, fully penetrating the aquifer or cavity well.
- The spacing of wells, in metres.
- Their diameter, in metres.
- The permeability of the aquifer and its thickness, in metres per day and in metres, respectively.

FIGURE A23.7
Printout of program NSHEAD

```

***** Non-steady flow above drain or ditch bottom *****
=====
project: aa; location: aa1; case: aa-01.txt

***** GENERAL INPUT DATA for NSHEAD ****
***** all heads above drain level *****
soil permeability          2.000  m/d
storage coefficient        .150  ---
thickness of soil below drain level  2.000  m
initial groundwater head   1.300  m
radial resistance Wr       .500  d/m
outflow system, design capacity .0100 m/d
outflow system, design head .500  m
max. evaporation          .0050 m/d
groundwater depth where E=.43E0 .500  m
*****

**** Results of NSHEAD, non-steady flow ****

***** Heads above drain level *****
t=time, hp=head in drain, h0=outside drain
h10=midway, h0-h11=proportional distances from drain

Drain spacing L  20.00 m
Rad. resistance Wr .50 d/m

  t  hp  h0  h1  h2  h3  h4  h5  h6  h7  h8  h9  h10  h11
.00 1.11 1.29 1.30 1.30 1.30 1.30 1.30 1.30 1.30 1.30 1.30 1.30 1.30
.15 1.03 1.21 1.24 1.25 1.27 1.28 1.28 1.28 1.29 1.29 1.29 1.29 1.29
.30 1.00 1.17 1.20 1.22 1.24 1.25 1.26 1.27 1.27 1.27 1.28 1.28 1.28
.45 .97 1.14 1.17 1.19 1.21 1.22 1.24 1.25 1.25 1.26 1.26 1.26 1.26
.60 .95 1.12 1.14 1.17 1.19 1.20 1.22 1.23 1.23 1.24 1.24 1.24 1.24
.75 .92 1.09 1.12 1.14 1.16 1.18 1.19 1.21 1.21 1.22 1.22 1.22 1.22
.90 .90 1.07 1.10 1.12 1.14 1.16 1.17 1.18 1.19 1.20 1.20 1.20 1.20
1.05 .88 1.05 1.08 1.10 1.12 1.14 1.15 1.16 1.17 1.18 1.18 1.18 1.18
1.20 .86 1.03 1.06 1.08 1.10 1.12 1.13 1.14 1.15 1.16 1.16 1.16 1.16
1.35 .84 1.01 1.03 1.06 1.08 1.10 1.11 1.12 1.13 1.14 1.14 1.14 1.14
1.50 .83 .99 1.01 1.04 1.06 1.08 1.09 1.10 1.11 1.12 1.12 1.12 1.12
1.65 .81 .97 .99 1.02 1.04 1.06 1.07 1.08 1.09 1.10 1.10 1.10 1.10
1.80 .79 .95 .98 1.00 1.02 1.04 1.05 1.06 1.07 1.08 1.08 1.08 1.08
1.95 .77 .93 .96 .98 1.00 1.02 1.03 1.04 1.05 1.06 1.06 1.07 1.06
2.10 .75 .91 .94 .96 .98 1.00 1.01 1.02 1.03 1.04 1.04 1.05 1.04
2.25 .73 .89 .92 .94 .96 .98 .99 1.01 1.02 1.02 1.03 1.03 1.03
2.40 .72 .87 .90 .92 .94 .96 .98 .99 1.00 1.00 1.01 1.01 1.01
2.55 .70 .85 .88 .90 .92 .94 .96 .97 .98 .98 .99 .99 .99
2.70 .68 .84 .86 .89 .91 .92 .94 .95 .96 .97 .97 .97 .97
2.85 .67 .82 .84 .87 .89 .91 .92 .93 .94 .95 .95 .95 .95
3.00 .65 .80 .83 .85 .87 .89 .90 .91 .92 .93 .93 .94 .93

```

FIGURE A23.8
Printout of program ARTES

```

***** Drainage under artesian conditions *****
=====
project: a; location: adana; case: a--01.txt
***** GENERAL INPUT DATA for ARTES *****
effective diameter of drain      .10 m
design recharge R (by rain or irrig.) .005 m/d
design grw. depth midway at R    1.40 m
design grw. depth midway at R=0  1.80 m
design drain depth                2.40 m
design entrance resist. into drain .00 d
*****

***** Data for case a--01.txt *****
Properties of top layer
thickness above drain level      2.40 m
thickness below drain level      5.00 m
anisotropy above drain level     1.00 --
anisotropy below drain level     4.00 --
hor.perm. above drain level      .20 m/d
hor.perm. below drain level      .40 m/d
Hydrology
resistance of aquitard          200.00 d
hydraulic head in aquifer        2.00 m
recharge (by rain or irrig.) R=  .005 m/d

----- Results of case a--01.txt -----
recharge (by rain or irrig.) R = .0050 m/d
seepage (neg. if downward)       .0048 m/d
spec. discharge above drain level .0023 m/d
spec. discharge below drain level .0075 m/d
head midway, at drain level       .98 m
groundwater depth midway         1.39 m
drain spacing . . . L-Brug. =    19. m

-----
Values for recharge R=0
recharge (by rain or irrig.)     .0000 m/d
seepage (neg. if downward)       .0061 m/d
spec. discharge above drain level .0010 m/d
spec. discharge below drain level .0051 m/d
head midway, at drain level       .60 m
groundwater depth midway         1.80 m
drain spacing . . . L-Brug. =    17. m

* * * Take SMALLEST value for spacing L * * *
*****

```

- The recharge (by rain or irrigation losses), in metres per day. Divide millimetres per day by 1 000.
- The resistance of the overlying layer, either directly (in days) or from its permeability and thickness.
- The shape of the network (quadratic or triangular arrangement of wells).

The input is shown. If correct, the heads far from and near the well are given on screen. These heads are expressed with respect to the soil surface, because there is no drain level in this case.

Continuing gives a table with expected aquifer heads at various distances, again with respect to the soil surface.

Continuation

The project can be continued and then the data for the new location are added to the same file. If a new project is taken or the existing one is ended, the files are closed and the filename is mentioned on screen.

Output and example

The results are visible on screen and put on file WN****.TXT, where WN denotes well network and **** the abbreviated project name. The filename is mentioned on screen and added to LISTWN.TXT. Any new project needs a different name.

An example is given in Figure A23.9.

DRAIN DIAMETERS

DRSINGLE, for single drain

After the three general questions (notation of decimal, project name, and location), the program moves on to specifics:

- Type of drains: options are available for laterals and collectors. The latter are characterized by greater spacing, and often also greater length.
- Type of pipe: smooth (theoretical) (1); technically smooth (in practice) (2); or corrugated (two options, general (3) or according to Zuidema for small pipes, [maximum diameter 0.12 m]). Option “general” (3) will ask for the spacing of corrugations.
- Maintenance status, that is the amount of sediment to be expected in this soil under usual maintenance. In some soils, drains will keep clean, even without or with infrequent maintenance; in others, the pipes will clog with iron hydroxides,

sediments, or roots, even with regular (e.g. annual) cleaning. The first will have a good status, the second a poor one. The quantity must be estimated from earlier experience. Where unknown, try 3.

- Required items: length, diameter, maximum spacing allowed, head loss in drain, all in metres and maximum specific discharge (discharge divided by area served) in metres per day.
- According to this choice, all other quantities except the unknown will be required. The result is shown on screen and all data are written to file.
- ENTER to continue. The program calculates the results and asks for a new item or to end.
- Same project, other one, or end? The first option allows another measurement in the same project. The others finish the calculation.

Continuation

In the “same project” case, the existing project file is continued. Otherwise, it is closed, and the filename is mentioned on screen as DS****.TXT, where DS denotes “Drain, Single” and **** is the given project name. All these names are collected in the file LISTDS.TXT.

If “Other project” is selected, new names are required for project and location. With “END”, the user returns to the initial screen.

Output and example

Figure A23.10 is an example for a collector of 1 000 m in length in an arid area.

DRMULTI, for multiple drain

The different materials of a multiple drain, consisting of sections with different diameters or materials (cement, smooth or corrugated plastic) must be specified, together

FIGURE A23.9
Printout of program WELLS

```

=====
Drainage by array of wells, steady state
project: b; location: babel; case: b---01.txt

Fully penetrating well
Requirement on groundwater depth
  min. depth          2.00  m
Well
  diameter            .20  m
Aquifer
  permeability        10.00 m/d
  thickness           40.   m
  recharge            .0030 m/d [3.0 mm/d]
System
  aquifer transmissivity 400. m2/d
  overlying resistance  200. d
  characteristic length 283. m
Network
  quadratic, spacing    200. m
  influence radius     113. m
  discharge per well   120. m3/d (equilibrium)
  head aquifer, limit  -2.60 m
  head aquifer, well   -2.91 m

radius m  head m  [ surface=0. ]
          groundwater  aquifer
   .10    -2.31    -2.91
   .11    -2.31    -2.91
   .28    -2.26    -2.86
  1.01    -2.20    -2.80
  2.99    -2.15    -2.75
  7.15    -2.11    -2.71
 14.71    -2.07    -2.67
 27.17    -2.05    -2.65
 46.28    -2.02    -2.62
 74.07    -2.01    -2.61
112.84    -2.00    -2.60
=====

```

FIGURE A23.10
Printout of program DR SINGLE

```

***** Dimensions of single drain *****
=====
project: abba; location: Saltabad; case: abba01.txt

-----
Drain pipe design: Single diameter
-----

Collectors
Technically smooth pipe, a-Blasius=0.40
Maintenance status: good

Input data
Drain length          1000.00  m
Collector spacing     300.00  m
Design head loss      .30  m
Design spec. disch.   .0030 m/d

Results
Min. inner diameter   .200  m
=====

```

with the available diameters, total length and spacing. The program then calculates the length of the different sections.

After the three general questions (notation of decimal, project name, and location), the program moves on to specifics:

- Type of drains (laterals, collectors, or interceptor drains).
- For laterals and collectors, data are asked for allowed head loss in drain and specific discharge; for interceptors allowed head loss and inflow per m' length (obtained from INCEP or INCEP2).
- The number of different sections is required.
- Type of pipe used in each section: smooth (theoretical) (1), technically smooth (in practice) (2), or corrugated (two options, general (3) or according to Zuidema for small pipes [maximum diameter 0.12 m]). Option "general" (3) will ask for the spacing of corrugations.
- Maintenance status for the entire drain. This is the amount of sediment to be expected in this soil under usual maintenance. In some soils, drains will keep clean, even without or with infrequent maintenance; in others, the pipes will clog with iron hydroxides, sediments, or roots, even with regular (e.g. annual) cleaning. The former will have a good status, the latter a poor one. The quantity must be estimated from earlier experience. Where unknown, try 3.
- Diameter of each section.
- For laterals and collectors: spacing and length; for interceptors: their length only.

Results

The necessary calculations are made and the result appears on screen, first for two sections only. Then:

- ENTER to see a graph showing the head at design discharge and the slope of the drain.
 - ENTER again to leave the graph.
- If more than two sections are being considered, this procedure is repeated for all sections involved: lengths of all sections on screen, followed by a graph. Then:
- ENTER to continue.
 - Same project, other one, or end? The first option allows another measurement in the same project. The others finish the calculation.

Continuation

In the "same project" case the existing project file is continued. Otherwise, it is closed, and the filename is mentioned on screen as DM****.TXT, where DM denotes "Drain, Multiple" and **** is the given project name. All these names are collected in the file LISTDM.TXT.

If "Other project" is selected, new names are required for project and location. With "END", the user returns to the initial screen.

Output and example

Figure A23.11 gives an example for laterals of 350 m in length in a humid climate.

MAIN DRAINAGE SYSTEM

BACKWAT, for backwater effects in the outlet channel of the main system

If an open channel of the main drainage system discharges via an open connection or sluice into a river, lake or sea, fluctuations in outside water level will influence the level in that channel. Especially high outside levels have an unfavourable and sometimes disastrous effect. Apart from a steady-state influence, also non-steady effects can be important in such cases. However, to form an idea of such effects,

a steady-state approach is useful in cases where storage of water inland is not too important and the fluctuations are relatively slow.

For such situations, the program BACKWAT gives a solution. Thus, travelling waves cannot be calculated. Therefore, application is limited to downstream sections and sections above weirs that are of not too great length and that receive a constant flow from upstream.

Both high and low outside levels are covered, and data about positive of negative backwater curves are given.

Program

After the three general questions (notation of decimal, project name, and location), the program moves on to specifics:

- Dimensions of watercourse: bottom width in metres, side slopes. The results are shown on screen and can be corrected if necessary.
- Longitudinal profile: length of section, land and bottom elevation, first upstream and then downstream, in metres.
- Water elevation downstream, in metres. The results are shown on screen and can be corrected if necessary.
- Discharge from upstream, in cubic metres per second. Correction is possible. The program gives the equilibrium depth far upstream. As a check, the discharge is recalculated.
- The step size in water depth, in metres, to be used in the numerical calculations.

The program shows the results. ENTER returns to “step size” so that another value may be tried. Indicating END at this stage (type 9) leads to a question about the next item.

Next item and example

Same project, other one, or end? The first option allows another measurement in the same project. The others finish the calculation and ask for a new project filename for another abbreviated filename.

In the “same project” case, the existing project file is continued. Otherwise, it is closed, the filename mentioned on screen and added to LISTBW.TXT. If “Other project” is selected, new names are required for project and location. With “END”, the user returns to the initial screen.

FIGURE A23.11
Printout of program DRMULTI

```
***** Dimensions of multiple drain *****
=====
project: ba4; location: Balsa34; case: ba4-01.txt
=====
Drain pipe design
-----
Number of sections: 2
Pipe type for lateral
section 1: corrugated, Zuidema (a-Blasius= .77), diameter .05 m
section 2: corrugated, Zuidema (a-Blasius= .77), diameter .08 m
section 3: corrugated, Zuidema (a-Blasius= .77), diameter .12 m
maintenance status: good
Input data
design head loss      .20 m
discharge intensity  .010 m/d
spacing of laterals  50.0 m
length of laterals   350.0 m
Output data
length of section 1:  .00 head loss .0000
length of section 2: 163.64 head loss .0935
length of section 3: 186.36 head loss .0966
length of drain   : 350.00 real loss .1901 allowed .2000
-----
Number of sections: 3
Pipe type for lateral
section 1: corrugated, Zuidema (a-Blasius= .77), diameter .05 m
section 2: corrugated, Zuidema (a-Blasius= .77), diameter .08 m
section 3: corrugated, Zuidema (a-Blasius= .77), diameter .12 m
maintenance status: good
Input data
design head loss      .20 m
discharge intensity  .010 m/d
spacing of laterals  50.0 m
length of laterals   350.0 m
Output data
length of section 1: 45.69 head loss .0261
length of section 2: 86.95 head loss .0497
length of section 3: 217.36 head loss .1026
length of drain   : 350.00 real loss .1784 allowed .2000
=====
```

FIGURE A23.12
Printout of program BACKWAT

```

***** Backwater curves *****
=====
project: aa ;location: adana; case: aa--01.txt
Backwater curves

Watercourse
  bottom width      5.00 m
  side slopes 1:    2.00
                    (1 vertical: 2.00 horizontal)

Elevations
  length of section 2000. m

  land upstream     6.00 m
  land downstream   3.00 m

  bottom upstream   4.00 m
  bottom downstream .00 m

  water downstream  2.00 m

  land slope        1.500 o/oo
  bottom slope      2.000 o/oo

Discharge from upstream = 10.000 m3/s

Equilibrium depth upstream 1.144 m
Calc. discharge Q          9.998 m3/s

distance  depth  water & land level  Q-calc
  0.      2.000  2.000  3.000  10.000
 28.      1.950  2.006  3.042  10.000
 56.      1.900  2.013  3.085  10.000
 85.      1.850  2.021  3.128  10.000
115.      1.800  2.030  3.172  10.000
145.      1.750  2.040  3.217  10.000
176.      1.700  2.051  3.264  10.000
208.      1.650  2.065  3.311  10.000
241.      1.600  2.081  3.361  10.000
275.      1.550  2.100  3.413  10.000
312.      1.500  2.124  3.468  10.000
351.      1.450  2.152  3.526  10.000
394.      1.400  2.188  3.591  10.000
442.      1.350  2.234  3.663  10.000
499.      1.300  2.297  3.748  10.000
571.      1.250  2.391  3.856  10.000
679.      1.200  2.558  4.019  10.000
1073.     1.150  3.296  4.610  10.000

```

An example is given by Figure A23.12.

INTERCEPTOR DRAINS INCEP and INCEP2, for homogeneous profiles and for a less permeable top layer

Interception drains are needed in places where waterlogging occurs in undulating terrain, especially to protect the downstream fields. This waterlogging is usually caused by a decrease in slope, a change in the soil profile or an abrupt lowering of the surface. In other cases, it is caused by leakage from irrigation canals and watercourses, or from higher lands. The program allows changes of this kind for a profile of permeable soil on an impermeable base. It calculates the width of a drain trench or ditch bottom that is sufficient to catch the intercepted flow. A separate calculation is needed for the size of the drain needed, this can be found by the program DRMULTI.

INCEP, homogeneous profile

After the three general questions (notation of decimal, project name, and location), the programs moves on to specifics regarding the upstream conditions:

- The source: hillslope, canal or higher fields.

In the case of hillslopes:

- The upstream slope, as the ratio 1: n (vertical: horizontal) of which n is required.
- The upstream permeability, in metres per day.

- The upstream depth of the impermeable base, in metres below surface.
- The upstream depth of the groundwater, in metres below surface.
- Depth of drain, below the upstream soil surface, in metres.

In the case of a leaky canal at higher level:

- The water losses from the canal, flowing to both sides in the present situation in square metres per day.
- The water level in the canal above the nearby soil surface.
- The original groundwater level below surface.
- The required future groundwater level below surface.

In the case of flow from higher ground:

- The flow from higher lands.
- The required future groundwater level below surface.

These data appear on screen. If correct, ENTER 1, else 2 to restart the questions. If correct, the downstream conditions must be specified:

- Flat or sloping surface?
- If there is a further downward slope 1:n, the downstream n is required, which must be more than upstream.
- The downstream permeability, in metres per day.
- The downstream depth of the impermeable base, in metres below surface.
- Depth of drain, below the downstream soil surface, in metres. For hill slopes, the difference with the upstream value determines the difference in surface elevation near the drain.
- The required downstream depth of the groundwater, in metres below surface.

These data appear on screen. If correct, ENTER 1, else 2 to restart the questions. If correct, the necessary calculations are performed and the results shown on screen, the main one being the width of the drain trench or ditch bottom needed to catch the intercepted flow. In most cases, a normal trench width is sufficient, the main exception being permeable soils of considerable depth.

Calculating the lowering of the groundwater upstream of the drain is an option for hill slopes.

INCEP2, less permeable topsoil

The program treats a two-layered soil with an upper layer at least ten times less permeable than the second one. Only a change in slope is considered.

After the three general questions (notation of decimal, project name, and location), the program moves on to specifics. These are similar to those for INCEP, plus:

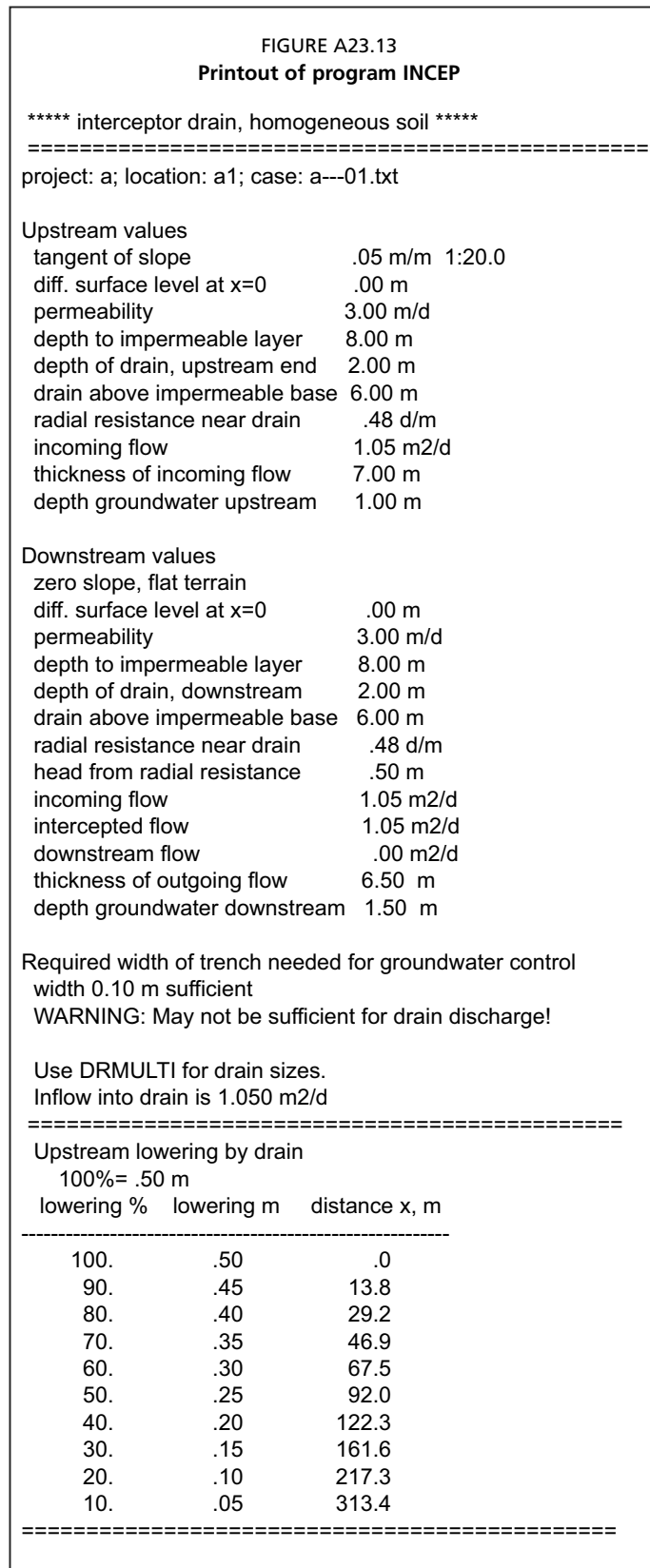

FIGURE A23.14
Printout of program INCEP2

```

***** interceptor drain, two-layered soil *****
=====
project: b; location: b1; case: b---01.txt
tangent of slope upstream      .05 m/m  1: 20.0
downstream slope zero,        flat terrain

no difference in surface level at x=0
permeability top layer        .30 m/d
permeability second layer     3.00 m/d
thickness top layer           4.00 m
thickness second layer        4.00 m
depth to impermeable layer    8.00 m

depth of trench or ditch      2.00 m
drain above soil transition    2.00 m
radial resistance near drain   .78 d/m
resulting head above drain     .50 m

incoming groundwater flow     .65 m2/d
outgoing groundwater flow     .00 m2/d
intercepted by drain          .65 m2/d
depth groundwater upstream    1.00 m
depth groundwater downstream  1.50 m
thickness of incoming flow     7.00 m
thickness of outgoing flow     6.50 m

Result: required bottom width  6.83 m
corrected linear approximation 6.84 m

Use DRMULTI for drain sizes.
Inflow into drain is .645 m2/d
=====

```

- Permeability of top layer, metres per day.
- Permeability of second layer, metres per day.
- Thickness of top layer, metres.
- Thickness of second layer, metres.

All entry data appear on screen. If correct, ENTER 1, else 2 to restart the questions. If correct, the necessary calculations are performed and the results shown on screen, the main one being the width of the trench or ditch bottom needed to catch the intercepted flow. In contrast to the homogeneous case, where a small width is usually sufficient, a drain in less permeable topsoil requires a much wider trench. As this is often not feasible, several drains are needed. Their mutual distance can be estimated for the program ARTES for artesian conditions, their number from the total flow to be eliminated.

Continuation, output and examples

The process can be repeated in a new case belonging to the same project. With another project or END, the files are closed and the results written to file ID****.txt, where ID stands for "Interceptor Drain" and **** is the abbreviated project name. These filenames are mentioned in LISTID.TXT.

Figure A23.13 gives the output of INCEP for a hillslope in project 'a', at location 'a1'. It can be seen that the effect of the radial resistance is negligible in this case, as is usual for homogeneous permeable soils of rather shallow depth.

Figure A23.14 gives results for a case similar to Figure A23.13, but now with the upper 4 m of low permeability and for a leaky canal. The increase in necessary bottom width is dramatic. Although the flow is similar, the required width changes from less than 0.10 m to more than 6 m. As this is impractical, several drains will be needed.

The hydrological conditions are usually more complicated at such locations and often poorly known. Therefore, the programs can give rough guidelines only, and solutions must often be found in the field by trial and error, adding more drains if needed until the result is satisfactory.

The inflow per m' drain can be used as input in the program DRMULTI to find the necessary dimensions of the drain itself.

FAO TECHNICAL PAPERS

FAO IRRIGATION AND DRAINAGE PAPERS

1	Irrigation practice and water management, 1972 (Ar* E* F* S*)	35	Mechanized sprinkler irrigation, 1982 (C E* F S*)
1 Rev.1	Irrigation practice and water management, 1984 (E)	36	Localized irrigation, 1980 (Ar C E* F S*)
2	Irrigation canal lining, 1971 (New edition, 1977, available in E, F and S in the FAO Land and Water Development Series, No. 1)	37	Arid zone hydrology, 1981 (C E*)
3	Design criteria for basin irrigation systems, 1971 (E*)	38	Drainage design factors, 1980 (Ar C E F S)
4	Village irrigation programmes – a new approach in water economy, 1971 (E* F*)	39	Lysimeters, 1982 (C E* F* S*)
5	Automated irrigation, 1971 (E* F* S*)	40	Organization, operation and maintenance of irrigation schemes, 1982 (C E* F S*)
6	Drainage of heavy soils, 1971 (E* F* S*)	41	Environmental management for vector control in rice fields, 1984 (E* F* S*)
7	Salinity seminar, Baghdad, 1971 (E* F*)	42	Consultation on irrigation in Africa, 1987 (E F)
8	Water and the environment, 1971 (E* F* S*)	43	Water lifting devices, 1986 (E F)
9	Drainage materials, 1972 (E* F* S*)	44	Design and optimization of irrigation distribution networks, 1988 (E F)
10	Integrated farm water management, 1971 (E* F* S*)	45	Guidelines for designing and evaluating surface irrigation systems, 1989 (E*)
11	Planning methodology seminar, Bucharest, 1972 (E* F*)	46	CROPWAT – a computer program for irrigation planning and management, 1992 (E F* S*)
12	Farm water management seminar, Manila, 1972 (E*)	47	Wastewater treatment and use in agriculture, 1992 (E*)
13	Water use seminar, Damascus, 1972 (E* F*)	48	The use of saline waters for crop production, 1993 (E*)
14	Trickle irrigation, 1973 (E* F* S*)	49	CLIMWAT for CROPWAT, 1993 (E)
15	Drainage machinery, 1973 (E* F*)	50	Le pompage éolien, 1994 (F)
16	Drainage of salty soils, 1973 (C* E* F* S*)	51	Prospects for the drainage of clay soils, 1995 (E)
17	Man's influence on the hydrological cycle, 1973 (E* F* S*)	52	Reforming water resources policy, 1995 (E)
18	Groundwater seminar, Granada, 1973 (E* F S*)	53	Environmental impact assessment of irrigation and drainage projects, 1995 (E)
19	Mathematical models in hydrology, 1973 (E*)	54	Crues et apports, 1996 (F)
20/1	Water laws in Moslem countries – Vol. 1, 1973 (E* F*)	55	Control of water pollution from agriculture, 1996 (E* S)
20/2	Water laws in Moslem countries – Vol. 2, 1978 (E F)	56	Crop evapotranspiration, 2006 (E S)
21	Groundwater models, 1973 (E*)	57	Soil salinity assessment, 1999 (E)
22	Water for agriculture – index, 1973 (E/F/S*)	58	Transfer of irrigation management services: guidelines, 1999 (E F R S)
23	Simulation methods in water development, 1974 (E* F* S*)	59	Performance analysis of on-demand pressurized irrigation systems, 2000 (E)
24	Crop water requirements, (rev.) 1977 (C* E F S)	60 Rev.1	Materials for subsurface land drainage systems, 2005 (E)
25	Effective rainfall, 1974 (C* E* F* S*)	61	Agricultural drainage water management in arid and semi-arid areas, 2002 (E)
26/1	Small hydraulic structures – Vol. 1, 1975 (E* F* S*)	62	Guidelines and computer programs for the planning and design of land drainage systems, 2007 (E)
26/2	Small hydraulic structures – Vol. 2, 1975 (E* F* S*)		
27	Agro-meteorological field stations, 1976 (E* F* S*)		
28	Drainage testing, 1976 (E* F* S*)		
29	Water quality for agriculture, 1976 (E* F* S*)		
29 Rev.1	Water quality for agriculture, 1985 (C** E* F* S*)		
30	Self-help wells, 1977 (E*)		
31	Groundwater pollution, 1979 (C* E* S)		
32	Deterministic models in hydrology, 1979 (E*)		
33	Yield response to water, 1979 (C* E F S)		
34	Corrosion and encrustation in water wells, 1980 (E*)		

Availability: March 2007

Ar	– Arabic	Multil	– Multilingual
C	– Chinese	*	Out of print
E	– English	**	In preparation
F	– French		
P	– Portuguese		
R	– Russian		
S	– Spanish		

The FAO Technical Papers are available through the authorized FAO Sales Agents or directly from Sales and Marketing Group, FAO, Viale delle Terme di Caracalla, 00153 Rome, Italy.

Guidelines and computer programs for the planning and design of land drainage systems

The aim of this paper is to facilitate the planning and design of land drainage systems for sound land and water management for engineers and other professionals. The text of this publication provides guidelines for the appropriate identification of drainage problems, for the planning and design of field drainage systems (surface and subsurface) and the main drainage and disposal systems. The annexes provide more detailed information with technical background, appropriate equations, some cross-references for finding appropriate methodologies, and computer programs for calculation of extreme values, of permeability and some land drainage system parameters. The paper considers the integration of technical, socio-economic and environmental factors and the need for system users' participation in the planning, design, operation and maintenance processes.

ISBN 978-92-5-105670-7 ISSN 0254-5284



9 789251 056707

TC/MA0975E/1/02.07/1100