

SORGHUM

Post-harvest Operations

 INPhO - Post-harvest Compendium



Food and Agriculture Organization
of the United Nations

SORGHUM: Post-harvest Operations

Organisation: Natural Resources Institute ([NRI](#))

Author: Food Security Department

Edited by AGSI/FAO: Danilo Mejia (Technical), Beverly Lewis (Language & Style)

Last reviewed: 14/10/1999

Contents

1. Introduction	1
1.1 World Trade	3
1.2 Primary product.....	4
1.3 Secondary and derived product.....	6
1.4 Requirements for export and quality assurance	7
2. Post-Production Operations.....	8
2.1 Harvesting	10
2.2 Transport	10
2.3 Threshing.....	11
2.4 Drying.....	11
2.5 Cleaning	12
2.6 Packaging	12
2.7 Storage.....	12
3. Pest control.....	14
3.1 Pest species.....	14
3.2 Pest control.....	15
4. References	16
Industrial use of sorghum.....	17
1. Introduction	17
1.1 Primary product.....	19
1.2 Secondary and derived product.....	20
2. Post-Production Operations.....	29
2.1 Pre-harvest operations	29
2.2 Harvesting	30
2.3 Threshing.....	30
2.4 Drying.....	30
2.5 Cleaning	31
2.6 Storage.....	32
3. Pest control.....	32
4. References	32

1. Introduction

Sorghum, *Sorghum bicolor*(L) Moench, is the fifth most important cereal after rice, wheat, maize, and barley. It constitutes the main food grain for over 750 million people who live in the semi-arid tropics of Africa, Asia, and Latin America. The largest group of producers are small-scale subsistence farmers with minimal access to production inputs such as fertiliser(s), pesticides, improved seeds (hybrids or varieties), good soil and water and improved credit facilities for their purchase.

Sorghums have a structure which is broadly similar to that of other cereals (Figure 1). The major components of the grain are the pericarp (outer covering), the testa between pericarp and endosperm (which may or may not be present), the endosperm, and the embryo.

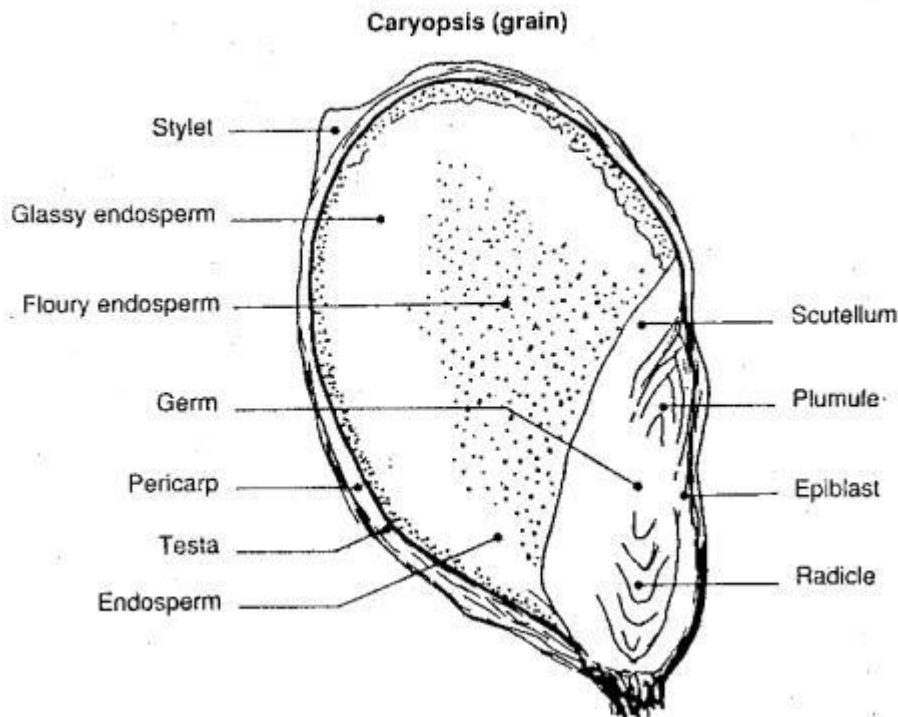

Figure 1: Structure of sorghum grain (after Sautier and O'Deye, 1989)

The endosperm may be corneous (vitreous) or floury, and the testa may contain tannins which affect the nutritional quality of the grain. Tannins are high molecular weight polyphenols (phenolics) which are found in grains with a brown pericarp and pigmented testa. Certain tannins known as condensed tannins, form complexes with proteins and reduce their digestibility. They can also form complexes with the alimentary tract proteases, reducing the digestibility of the proteins in the grain. Despite this negative nutritional effect, high tannin varieties continue to be grown due to their bird and insect resistance, and higher malting potential than white grain varieties. In some traditional foods and beverages, the phenolics of red sorghum give a desired flavour and colour. The negative effects of tannins on nutritional value can partially be overcome by removal of the testa by mechanical dehulling, or by alkaline treatment at the village level (traditionally by using wood ash) (Chantereau and Nicou 1994).

There are many varieties of sorghum ranging in colour from white through red to brown. Traditional varieties are open pollinated from which rural farmers retain seed for planting in the next season. Yields tend to be lower than the modern hybrids which are slowly being introduced. However hybrids are only cost effective when grown with supporting inputs of fertiliser, weed and pest control, and good water management. Commercial production of hybrid seed is a problem in many developing countries, and some rural farmers do not appreciate that harvested hybrid grain cannot be retained for planting the next season. Therefore they find sorghum production from hybrid seed expensive, even though the yields are higher than the land races.

Yields from open-pollinated varieties under rain-fed conditions range from 0.3-1.0 tons / ha. In contrast, hybrids can yield up to 12 t / ha under ideal inputs, soil and water conditions and higher densities of planting. Resource-poor farmers prefer varieties incorporating the characteristics of resistance to insects, disease, drought, birds, and with acceptable yields of

both grain for human consumption and fodder for livestock feed. Although yields of traditional varieties are low, they are sustainable under conditions which would make maize production unfeasible or unprofitable. Commercial producers prefer dwarf varieties suitable for harvest by combine.

Grain sorghums are generally grown in regions which are too dry or too hot for successful maize production. They are adapted to the drier climates due to several factors (Bennett et al. 1990):-

The ability to remain dormant during drought and then resume growth;

Leaves roll up as they wilt reducing the area of leaf exposed for transpiration;

Leaves and stalks contain an abundance of waxy coating which protects them from drying;

Sorghum exhibits a low transpiration ratio (kg water required to produce a kg of plant material) e.g. 141 kg for sorghum, 170 kg for maize and 241 kg for wheat;

Sorghums have a large number of fibrous roots that efficiently extract moisture from the soil (the absorption area is about twice that of maize); roots may be up to 2.5m in length;

A large root absorption area and relatively large leaf area;

Sorghums can withstand temperatures above 38 °C, but dry winds coupled with hot weather during pollination reduce yields. Best yields are realised when temperatures during the season are 24-27 °C;

The water requirements for sorghum vary within the range 350-700 mm depending on the length of the growing cycle; short growing cycle is 90 days; long growing cycle, more than 130 days.

Within many semi-arid areas of developing countries, typical temperatures range from 20-38 °C with annual rainfall ranging from 300-750 mm. In the USA, hybrid grain sorghums are grown where annual rainfall ranges from 380-640 mm. The growing season is longer than 130 days.

To obtain optimum yields in conditions of good soil fertility, a short growth cycle variety needs between 500 to 600 mm of well distributed rainfall; 650 to 800 mm for an average growth cycle variety; and 950-1100 mm for a long growth cycle variety. Since sorghum is predominantly a rain-fed crop grown by subsistence farmers, yields largely depend on the capacity for drought resistance of the variety used.

Sorghums can tolerate a wide range of soil pH and textures.

1.1 World Trade

Sorghum, apart from being a subsistence crop, is an important commercial and export crop for the United States of America, Australia, and Argentina. In these countries dwarf hybrid varieties are grown and harvested mechanically, predominantly for livestock feed. The major areas of sorghum production are listed in Table 1 (FAO, 1995).

Table 1. World sorghum production by area, yield per hectare and tonnage per region.

Sorghum Production Area (million ha)				
	1989-91	1993	1994	1995
World	43.4	43.2	44.8	43.8
Africa	18.5	20.6	23.3	22.0
N C America	6.1	5.2	5.2	5.2
South America	1.4	1.3	1.3	1.0
Asia	16.6	15.4	14.2	14.8
Europe	0.2	0.2	0.1	0.1
Oceania inc. Australia	0.5	0.4	0.5	0.5

Sorghum Production Yield (MT / ha)				
	1989-91	1993	1994	1995
World	1.31	1.37	1.36	1.24
Africa	0.76	0.81	0.78	0.79
N C America	3.38	3.50	3.91	3.18
South America	3.71	3.76	4.53	3.51
Asia	1.02	1.19	1.19	1.06
Europe	4.07	4.86	4.34	4.32
Oceania inc. Australia	2.15	1.28	1.90	2.02

Sorghum Production (million MT per region)				
	1989-91	1993	1994	1995
World	57.1	59.1	60.7	54.1
Africa	14.0	16.8	18.3	17.4
N C America	20.6	18.2	20.2	16.5
South America	3.6	4.4	3.7	3.0
Asia	17.1	18.2	16.9	15.7
Europe	0.6	0.8	0.6	0.6
Oceania inc. Australia	1.0	0.5	0.9	1.0

The trade in sorghum is small compared with the major grains such as wheat, maize, barley and rice. The main importers of sorghum are Japan, Mexico, the former USSR (CIS) and Venezuela. Within most developing countries, the sorghum crop rarely reaches the market. It is grown for home consumption unless there is a bumper crop, or if cash is needed. The major producers of sorghum for domestic or foreign trade are the USA, Argentina and Australia. Most is used in livestock feed.

The market price for sorghum is a function of its value in terms of its demand, its purpose, and nutritional quality. Livestock feed manufacturers procure feed materials according to a price per nutrient basis. Since the nutritional value of sorghum is broadly 85 percentage - 90 percentage of that of maize (due to the lower digestibility of the nutrients it contains), assuming that both were equally available, sorghum would have lower relative value. In reality, the price of grains has been influenced by political, social and agronomic factors, not always in support of sorghum, and often in support of maize, usually involving a subsidy.

1.2 Primary product

In communities where sorghum is grown as a subsistence crop the main food products prepared include thin and thick porridges, fermented and unfermented breads, lactic and alcoholic beers and beverages, malted flours for brewing, malted porridge mixes and weaning foods. In Kenya and South Africa, there is a small but growing market for pearled sorghum as an alternative to rice. In India, proposals have been made for use of dehulled sorghum within feeding regimes for infants and children (Pushpama, 1987)

Many countries have investigated the options for a composite wheat-sorghum flour but few have found commercial adoption. Sorghum does not contain the elastic protein, gluten, and thus the functional properties of sorghum for wheat-based bread and biscuit type products limits its inclusion level to a practical maximum of 10-15 percentage before changes in the structure of the product can be positively identified. Inclusion is also dependent upon availability of sorghum, appropriate varieties and the relative price of wheat and sorghum at the mill gate.

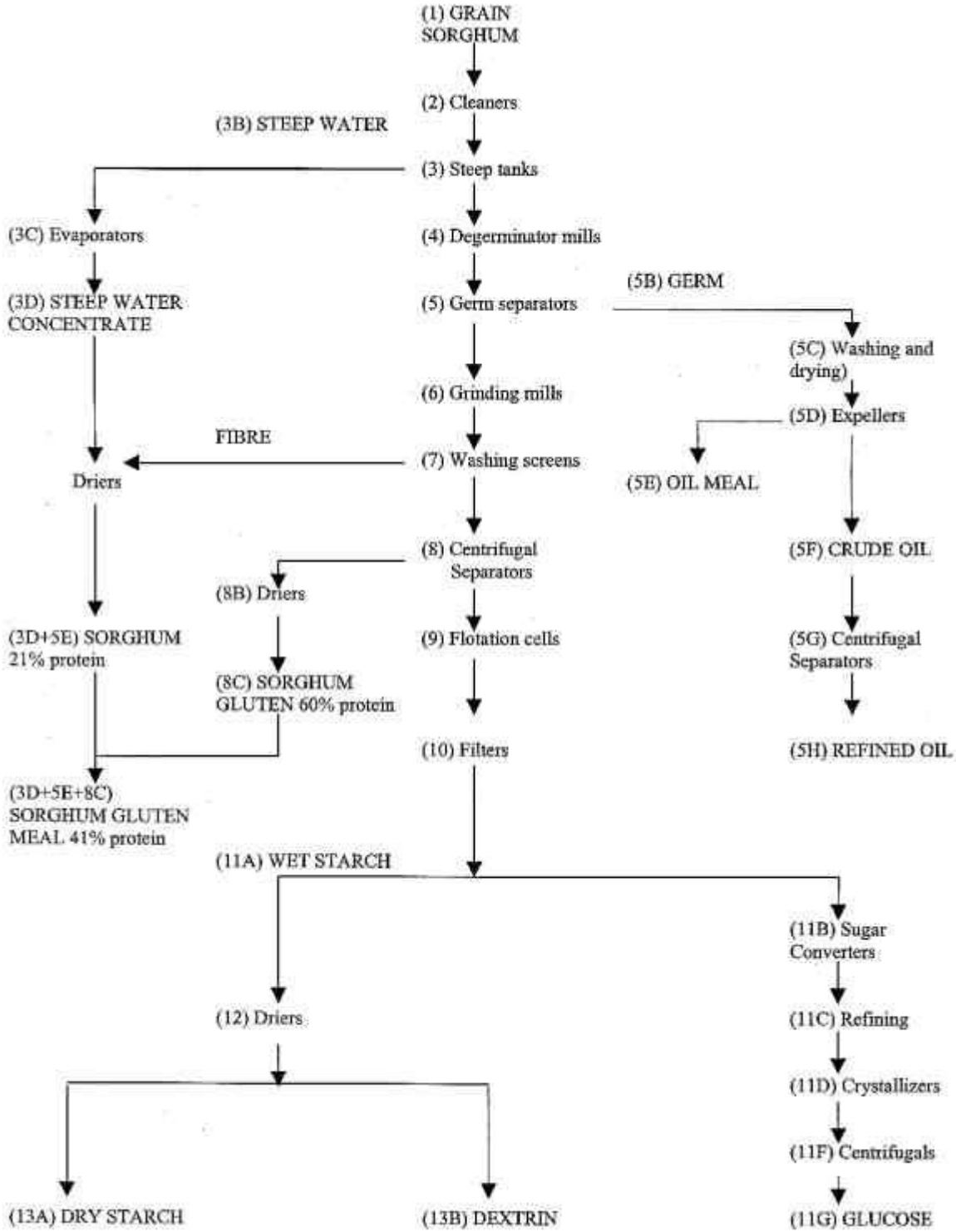

Figure 3: Flow sheet of grain sorghum wet milling (after Watson 1970)

Many urban consumers consider sorghum to be a subsistence crop of low quality. This low social status for the grain constrains its desirability for inclusion in commercial products designed for urban consumers. In regions where the crop is not a staple, it may have low acceptability relative to maize due to its different organoleptic properties - unpleasant colour, aroma, mouthfeel, aftertaste and stomach-feel.

1.3 Secondary and derived product

Brewing

Lager beers: Certain varieties of red sorghums contain active amylases at concentrations suitable for certain brewing applications. For the preparation of commercial lager beers, sorghum malt is not a direct replacement for barley malt since the diastatic power of the sorghum malt is very low and variable compared to that for barley malt. Sorghum is milled for its endosperm grits as a starch source (adjunct) for hydrolysis by malt enzymes to fermentable sugars. Supplementary amylolytic and proteolytic enzymes are necessary to complete the fermentations. (Hallgren, 1995)

Opaque beers: Africa has a tradition of making opaque beers by the use of sorghum as the source of malt and the adjunct, though for commercial brewing maize may often be the source of the adjunct. Opaque beer is a product of a lactic and alcoholic fermentation which is sold in a microbially active state, with a shelf life of only 5-7 days. The principles of the process whether by traditional or commercial methods are illustrated in Figure 4 (Daiber and Taylor, 1995).

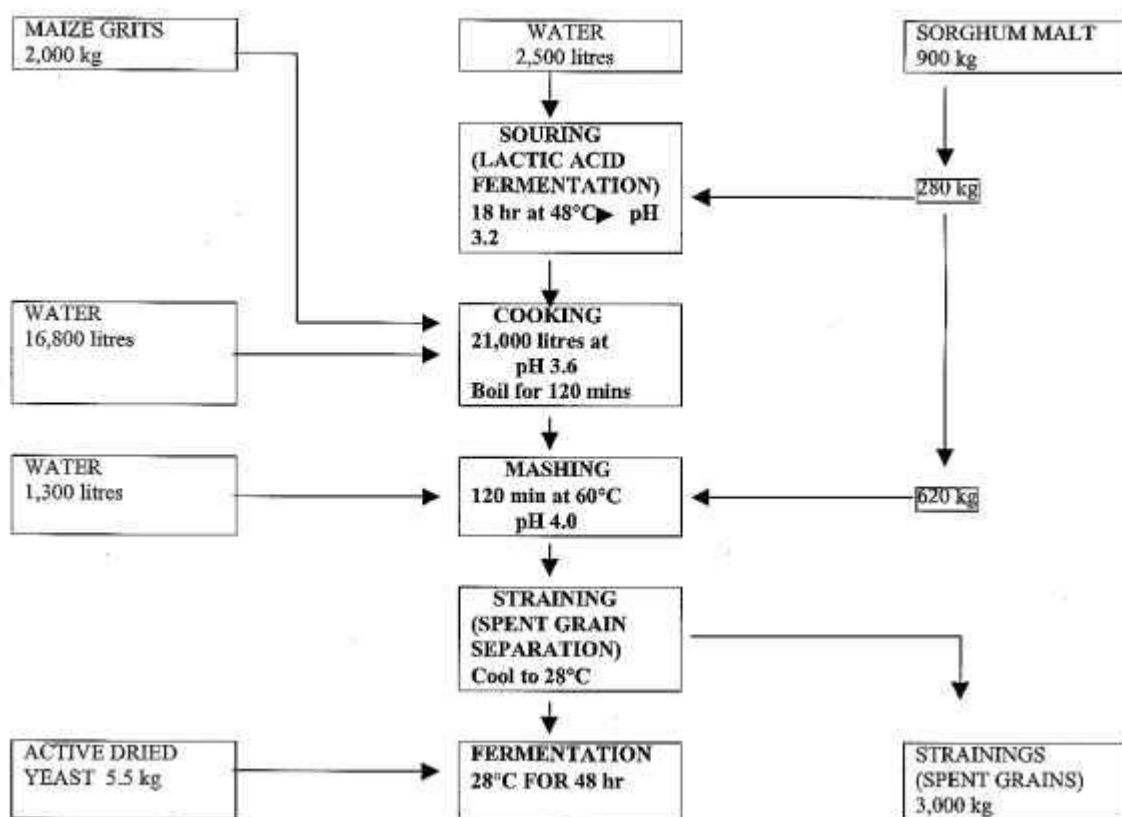

Figure 4: Principles of the production of opaque beer by the Reef-type brewing process.

Sweet sorghum

Certain varieties of sorghum are characterised by the production of high levels of sugar in the stalk. These are known as sweet sorghums and attempts have been made to commercialise their production in the USA, Argentina and Brazil for the extraction of juice for the preparation of sugar syrup for alcohol production by fermentation.

Sorghum in animal feeds:

Livestock feed manufacturers prefer to use grains from white sorghums or low tannin pigmented sorghums due to the effect of tannins on protein digestibility. Sorghum is therefore not a direct replacement for maize in a livestock ration. Sorghum has a lower energy density and protein digestibility compared to maize (Table 6) which is reflected in the price offered for sorghum (NRI, 1988).

Table 6. Comparative data on energy and protein levels for sorghum and maize (as feed)

	Metabolisable energy for ruminants (MJ / kg)	Metabolisable energy for poultry (MJ / kg)	Protein content (%)	Lysine content (%)	Available lysine content (%)
Sorghum	12.4	13.7	11.0	0.27	0.19
Maize	12.1	14.2	9.0	0.27	0.22

Typical upper inclusion limits for sorghum and maize in feeds are;

Sorghum Maize

Poultry feeds 30 percentage 70 percentage

Pig feeds 30 percentage 30 percentage

Dairy feeds 50 percentage 70 percentage

Beef feeds 70 percentage 70 percentage

The above are guideline figures since the inclusion levels will be dependent upon the price and availability of other raw materials providing the desired protein and energy for a balanced diet in relation to expected levels of animal performance.

However, a major reason for low inclusion of sorghum in livestock feeds in developing countries is lack or inconsistency of supply in the market.

1.4 Requirements for export and quality assurance

The Codex Alimentarius Commission has established global standards for sorghum grains under Codex Standard 172-1989. However, individual producing countries have their own standards for internal procurement from farmers or by import. In commercial trading the quality standard for sorghum is agreed between buyer and seller and is usually associated with the intended use of the crop. Nevertheless, the principles of the Codex standard may be included within the specifications.

Summary of Codex Standard 172-1989

The standard applies to sorghum for direct human consumption.

Grains shall not have abnormal odour or taste.

Grains may be white, pink, red, brown orange or yellow or may be a mixture of grains.

Grains must be sound, clean and free from living insects.

Moisture content will not exceed 14.5 percentage; ash not more than 1.5 percentage on dry matter; protein (N x 6.25) not less than 7 percentage on dry matter basis.

Tannins: For whole grains - not to exceed 0.5 percentage on dry matter. For decorticated grains - not to exceed 0.3 percentage on dry matter basis.

Hygiene

Grain should be prepared in accordance with the Recommended International Code of Practice, General Principles of Food Hygiene (CAP / RCP 1-1969, Rev. 2, 1985).

Free from micro-organisms, substances originating from micro-organisms, or other poisonous substances in amounts which may represent a hazard to health.

Packaging

Packed in containers (including sacks) which will safeguard the hygienic, nutritional and technological qualities of the grain.

A summary of general tolerances for grain defects is given in Table 2.

Table 2. Tolerances for defects in sorghum

Defect	Limit	Definition
Blemished grains including diseased grains	3.0% 0.5%	Insect or vermin damaged. Sprouted, diseased, frost damaged or other. Evidence of decay, mould or bacterial decomposition.
Broken kernels	5.0%	Pieces which pass through a screen with round holes 1.8 mm in diameter
Other grains	1.0%	Non-sorghum - legumes, pulses, other edible cereals.
Foreign matter including inorganic matter	2.0% 0.55% (inorganic matter)	All organic and inorganic material which is not sorghum, broken kernels, other grains and filth. Includes loose sorghum seedcoats.
Filth	0.1%	Impurities of animal origin.
Toxic or noxious seeds	Free from amounts which may be a hazard to health.	
Contaminants	Free from heavy metals in amounts hazardous to health.	

2. Post-Production Operations

Dehulling (removal of the pericarp)

Traditional methods

Traditional methods are time-consuming and arduous. In most traditional processes, the grain is dampened and dehulled by hand pounding in a mortar and pestle. There are local variations in this process, though common steps are:

Moisten a quantity of grain in an excess of water for about 10 minutes;

Drain off water, add grain to mortar and pound to abrade grains against each other;

Winnnow off separated pericarp;

Moisten grain again with a few handfuls of water;

Repeat pounding;

Winnnow off separated pericarp;

Sun dry the grain.

The time required for dehulling depends on the skill of the operator and the variety. Typical times for dehulling would be 15 kg in 1 hour.

Machine dehulling

In recent years, the dehulling of sorghum has been successfully mechanised through the adaptation of carborundum disc barley pearling machines (Reichert, 1982). These machines dehull and debran with a single pass through the machine. The design is illustrated below in Figure 2.

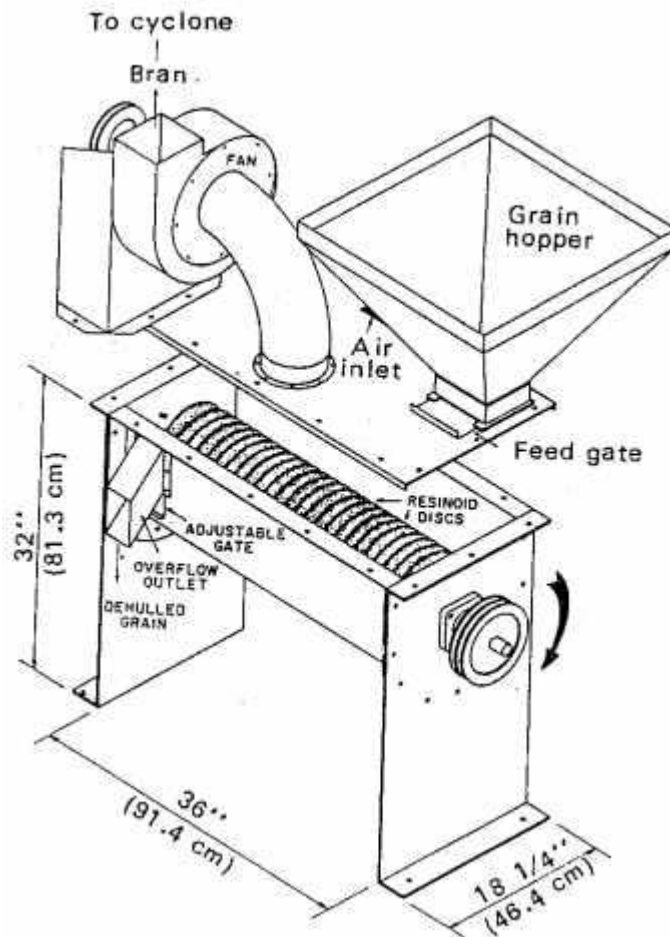

Figure 2: Typical carborundum stone type sorghum dehuller (after Reichert 1982)

Bran is separated by fan aspiration as the grain revolves between the abrasive disks. The extent of dehulling depends on the size, moisture content and hardness of the grain, the dwell time in the machine and the speed and surface characteristics of the carborundum disk. Hard varieties can yield a pearled sorghum product similar to rice, whereas soft floury endosperm varieties can shatter in the machine producing a coarse flour. Bran removed from the dehulling can be used as an animal feed.

However, abrasive disc dehulling has not found universal acceptance in developing countries. Problems have occurred due to limited technical and entrepreneurial skills of the operators, limited support from the manufacturers and difficulties in obtaining foreign exchange for the purchase of spare parts. Nevertheless in Botswana, where sorghum is the national grain, dehulling has been readily accepted by the small-scale private miller.

Traditional milling is by pounding sorghum grain in a mortar and pestle or stone grinding. The whole grain is thus converted to a wholemeal flour. This is the most arduous task of milling grains. To pound 15 kg of sorghum grain to a flour may take 3-5 hours. At rural level the sieving of flours to produce flour grains of specific particle size for specific culinary uses has yet to be introduced. In some parts of the world e.g. the Sudan, sorghum may be wet-

ground by rubbing soaked grain between two stones until a fine paste is produced. This paste is used directly or left to ferment.

Machine grinding

Hammer mills

Power driven hammer mills are becoming increasingly available and offer options for reducing grain to a flour. These are:

take the cleaned grain directly to a hammer mill;

dehull at home and then hammer mill;

dehull and debran the grain in a mechanical abrasive disc dehuller and grind the grain to a flour by hammer mill, plate mill, stone mill or roller mill.

In rural Zimbabwe the relative charges for dehulling and milling are approximately equal. The charge for dehulling 12 kg sorghum was Z\$ 4. Charge for milling dehulled grain to flour was Z\$ 4. In this case the miller kept the bran for sale as animal feed. Alternatively the charge for milling whole grain was Z\$ 6 per 12 kg (Wood and Thomson, 1997)

Roller milling

Sorghum can be roller-milled if the variety has the desirable qualities for pericarp / bran removal, though the efficiency of bran separation from the grain is lower than that for wheat due to its different physiological structure. It is difficult to obtain a clean separation of white endosperm from the bran fraction and the final flour has a speckled appearance. Soft endosperm varieties can easily shatter in a roller mill producing a wholemeal flour with fine bran which may be difficult to remove by sieving (Hulse et al 1980). A milling process involving the friction decortication of sorghum followed by roller milling has been developed in Denmark. If the raw material is properly conditioned, the process produces more or less intact sorghum endosperm (grits) and embryo removal.

In another research development of the roller milling process, grains are soaked to a moisture content of 20-27 percentage before roller milling. This semi-wet process appears to have considerable advantage especially in milling high tannin sorghums, but extraction rates of flours are lower than commercially acceptable in milling low-tannin varieties (Munck, 1995).

Wet milling for starch extraction

Starch can be extracted from sorghum by wet milling. The process is similar to that for starch extraction from maize and is illustrated in Fig 3 (Watson, 1970). The pigments of sorghum may discolour the final starch, and to prevent this low-tannin sorghums without testa are preferred.

2.1 Harvesting

In developing countries, almost all sorghum is harvested by hand. The panicle is cut from the standing stalk at about 16-20 percentage moisture content, and the stalks left for animals to graze the best of the residual leaf material. In other communities, the stalks are cut and stored for use as dry season animal fodder, or for house thatching and fencing. Late harvesting can lead to spontaneous shedding of the grain from the panicles resulting in significant losses and grain deterioration due to rapid changes in temperature and humidity.

In the USA, Australia and Argentina where dwarf hybrids are popular, the sorghum grain is threshed from the standing stalks by combine harvester. Grain with up to 25 percentage moisture content can be harvested, but requires careful drying before storage.

2.2 Transport

The bulk density of sorghum grain at 520-720 kg/cu.m. is similar to that of maize and hence transport costs will be comparable for any particular type of consignment - bag or bulk.

2.3 Threshing

In rural Africa, threshing involves beating the dried sorghum panicles with sticks on the ground or in sacks, or using a mortar and pestle. Grain is separated from dirt and chaff by winnowing. The time required for threshing depends on variety, the degree of dryness of the grain, and the method of threshing. In some places in India, a common practice for threshing the grain is to place it on the road for vehicles to run over. It has been recorded that 2-4 ha of grain (approx. 1-2 tons) can be threshed on the road in one day by a few people. Normally about 35 labourers are required to thresh about one half hectare (300-400 kg).

General guidelines for improved threshing efficiency and yield at rural level:

To reduce the amount of winnowing, thresh the panicles on mats, adobe or cement blocks, not on sand, gravel or stones;

Thresh early to reduce field exposure to birds, rats, etc. (ensure that the moisture content is low enough);

Maximum moisture content of the grain before storage should be 10-12 percentage;

Vitreous, flinty-starch type sorghums should be threshed early to reduce the number of broken grains.

The grain may be stored as unthreshed panicles or threshed before storage. Both storage methods are practised, but small-scale producers tend to store the grains unthreshed.

In many developing countries, motorised threshers have found mixed acceptability due to breakage of softer varieties of grain, problems of machine maintenance, and availability of spare parts. They operate by passing the grain-bearing panicles between a moving rotor and a fixed metal plate. The loosened grains and panicle fibres are separated in a forced air current. Where farms are sufficiently large, threshing can be achieved using mechanical combines at the time of harvest (Vogell and Graham, 1979).

2.4 Drying

The moisture level of sorghum must be reduced to a safe level (10-12 percentage) before storage.

The reasons are:

To prevent mould growth (and thus the possibility of mycotoxin development by a range of storage fungi - especially *Aspergillus flavus* - which can, under appropriate storage and field conditions, produce carcinogenic aflatoxins);

To reduce the likelihood of insect attack;

To prevent grain germination.

For all stored products, the maximum "safe" moisture content for storage is that which is in equilibrium with 70 percentage RH, but lower levels (in equilibrium with 65 percentage RH) are advisable if quality loss is to be minimised (Mc Farlane et al., 1995).

During storage the moisture content of the grain will equilibrate to a level which equates with the vapour pressure deficit (which is a function of relative humidity and temperature). Moulds develop if the moisture content is above 15 percentage and the temperature above 24°C.

Field drying: In many semi-arid areas, the traditional varieties tend to ripen after the rainy season and dry satisfactorily on the panicle. The most common method is to stack bundles of panicles in the field and allow them to dry in the sun. Grain on the panicles or as threshed grain should be kept off the ground on raised platforms, mats, or trays whilst it is being dried. Many insects will walk away from grain spread in the sun or are killed if the temperature of the grain is high.

The time taken for sun drying of threshed grains depends on the ambient temperature, relative humidity, depth of grain, bulk density and the frequency of turnover. In India, on a mud floor, sorghum grain in a layer of 20-mm depth can be dried from 16 percentage to 9 percentage moisture in one day. Drying requires 12 man-hours of labour for spreading and turning the

grain (Gireshe et al 1990). In a study on the drying of sorghum in the shade, the moisture content of the grain was reduced from 32 percentage to 13 percentage in 24 hours at a daytime temperature of 29_C.

In developing countries, the sorghum grain is sun dried on the panicle, and/or after threshing. When the economies of scale permit, sorghum grain may be dried by warm forced air. Drying temperatures and flow rates will depend upon the design of the drier and the relative humidity of the incoming air (Table 3)(McFarlane et al., 1995).

Table 3. Three principal systems for mechanical drying of sorghum grain

Drying with unheated air forced through a drying bin	Air drying with supplementary heat when the ambient RH is greater than 75%	Heated air drying
<p>Lowest investment Simple to operate. Relatively ineffective in wet weather or if RH is >75%. Recommended airflow rates: 0.02 cu.m/sec per cu.m sorghum at 14% moisture content (wet basis) up to 0.04 cu.m/sec per cu.m. sorghum at 20% moisture content to provide the most economic drying.</p>	<p>Heat generated from oil, gas or electric heaters during prolonged cold and wet weather. Drying temperatures should not exceed 40_C. Drying times shorter than unheated air reducing risk of mould growth.</p>	<p>Batch or continuous systems using constantly heated air. Relatively sophisticated high investment costs. Typical airflows in the range 0.5-1.5 cu.m/sec per cu.m. of sorghum for batch drying and 1.5-2.5 cu.m/sec per cu.m sorghum for continuous dryers. Short drying times.</p>

2.5 Cleaning

In traditional systems, grain cleaning is achieved by winnowing (to remove the low density material such as leaf and stalk), while washing in water will remove most dust and stones. In mechanised systems, forced air (aspiration) is used to remove low density material, while most stones, dust and other material is removed as the grain passes over a series of screens. Ferrous metal should be removed by a permanent magnet placed in the flow path of the grain.

2.6 Packaging

Bags used for sorghum can be made of jute, cotton, woven polypropylene or multi-layer paper. Woven polypropylene bags are light in weight, low cost and permit aeration. Their disadvantage is that hooks can irreparably damage the bags, they have a slippery surface and can be difficult to stack.

Sacks are often re-used and care should be taken to prevent reinfestation of clean grain by boiling sacks in water and thorough drying.

2.7 Storage

The goal of good storage is to be able to deliver grain from store in good quality and with no loss in quantity. This is achieved by preventing the deterioration caused by:

- Adverse climatic conditions;
- Contamination by extraneous material;
- Grain germination; and
- Pest infestation.

Ensuring that the storage environment is clean and tidy and in a good state of repair, makes a major contribution to the quality control during storage, but it is insufficient to prevent losses by pests.

Since the introduction of high-yielding varieties, there has been a noticeable shift in the requirements to upgrade storage practices at both the rural and the commercial level. Traditional varieties tend to be resistant to insect damage whereas the hybrids are considerably more vulnerable. This difference in storage stability has raised the profile for appropriate methods for insect control in stored sorghum.

Sorghum can be stored on the panicle or as a threshed grain. At the household level, sorghum grains are kept in a variety of stores for day to day food needs, seed, sale and as insurance against the risk of periodic grain shortages. Where containers are open to air movement, such as open-walled wooded cribs, the panicles may be put in store at 15-16 percentage moisture content. Low relative humidity after harvest ensures that the grain continues to dry while in store. This figure is well above the 12 percentage moisture threshold for safe storage of threshed grain.

Storing grain on the panicle reduces the vulnerability of traditional varieties to pest and mould damage, but takes up a larger space in storage, and unthreshed grain is difficult to protect with insecticides.

Locally available materials used for storage structures include soil from termite mounds, wood, plant stalks, straw, bricks and cement. Forest products for store construction and insect control are becoming increasingly scarce as the demand for wood for fuel and construction timber increases. At the same time skills to build granaries from local materials are disappearing as young men leave villages for work in urban areas.

Common forms of storage include jute bags, metal drums and bins, baskets, underground pits, clay pots and bins of stone or mud plaster. If grain is required for seed it is often dried on the panicle. The advantages and disadvantages of different methods of storage are summarised in Table 4.

Table 4. The advantages and disadvantages of different methods of storage

Method of storage	Advantages and disadvantages
Jute bags	When kept on raised platforms they allow air movement through the grain and can be repaired and re-used. Disadvantages: high cost, risk of loss through theft, water or pest damage.
Metal drums, bins and clay pots	Can be hermetically sealed, long life if shaded from direct sunlight. Good protection from external pest attack. Disadvantages: minimal air exchange for moisture control. Grain must be dry before storage.
Baskets woven from stalks and plastered with mud / cow dung.	Large quantities stored at low cost - this is the most common storage method used by small-scale producers Disadvantages: vulnerable to pest damage
Underground pits. Walls usually heated with fire and lined with straw, brick or cement. Sealed with a straw/mud plug.	Large quantities stored at low cost; relatively secure from theft. Disadvantages: grain can be seriously affected by mould growth and mycotoxin development
Bulk silos or granaries	Steel, aluminium or concrete structure built to heights of 30-50m. Heat transfer from corrugated sheets is less than from plain sheets. Plain sheets are preferred for areas with wide diurnal variations in temperature. Effective for centralised storage and distribution. Disadvantages: High operational and social costs.

Traditional storage systems are well suited to their environments and the varieties of grain being stored. Losses are generally low, below 5 percentage of grain weight over a season. In India, local sorghum varieties show weight losses of 1 to 2 percentage after 12 months storage, compared with up to 30 percentage for hybrid varieties. Early workers confused percentage damaged grains with weight loss and reported losses exceeding 30 percentage in some countries.

Storage treatment practices must be effective whether at the level of rural crib, underground pit or concrete silo. For effective sorghum storage, the following items should be assessed:

Type / variety of grain;

Post-harvest handling methods (threshing, drying, transport) and constraints;

Advantages and disadvantages of traditional storage methods;

causes, extent and value of storage losses;

What the farmer is doing to minimise the loss;

Why the farmer is storing, and future expectations;

available, appropriate methods of storage loss reduction;

The cost and benefits of existing, and alternative methods of loss reduction, taking account of cash, material, labour inputs and anticipated market prices.

3. Pest control

3.1 Pest species

A wide range of insect pests attacks all stored sorghum grains and grain products in the arid and semi arid tropics. Typical conditions for infestation and damage for stored sorghum grains are summarised in Table 5.

Table 5. Conditions for infestation and damage for stored sorghum grains

Insect	Optimum conditions for infestation	Damage symptoms and losses
<i>Rhizopertha dominica</i>	Heating follows infestation	Adults and grubs make ragged holes in grain; losses in improved cultivars range from 17-66% (Gupta et al., 1977).
<i>Sitophilus oryzae</i>	Preferred moisture content 10-16%. Red varieties with soft endosperm are more susceptible.	Adults and larvae feed on grain; losses 2-21% for improved cultivars in India (Gupta et al 1977).
<i>Tribolium castaneum</i>	Does not attack whole grain; feeds on damaged grains; fairly resistant to high temperatures.	Tunnelling damage; when attack is severe, grains turn greyish yellow and mouldy with pungent smell.
<i>Sitotroga cerealella</i>	Infestation starts in the field; develops rapidly on low moisture content sorghum stored on the panicle.	Field infestation on the upper layer of the grain; larvae bore and consume grain contents adding excreta and webbing.
<i>Ephestia cautella</i> , <i>Plodia interpunctella</i> , <i>Corcyra cephalonica</i>	Adult moths are active at dawn and dusk, particularly during periods of high humidity; inactive in complete darkness	Attack the embryo of whole grains; thick web left on grain surface; can cause losses in excess of 10%

3.2 Pest control

Sorghum is a vital subsistence crop for rural populations in semi-arid regions and most farmers are aware that newer high yielding varieties are more susceptible to storage insects. Good management practices, including: examining stores regularly for signs of insects, moulds and rodents; cleanliness in and around the grain store; and cleaning, and keeping grain dry, all contribute to quality and reduce the extent of losses. Varietal resistance to insect attack, physical, mechanical and botanical pest control measures integrated with minimum use of insecticides reduce considerably the damage done by pests.

Fumigation of grain is a widely used method of controlling storage insects. The practice is usually restricted to commercial stores where adequate safety precautions can be maintained. The two most commonly used fumigants are methyl bromide and phosphine. Methyl bromide is in the process of being withdrawn from use because of its ozone depleting properties, and is no longer recommended.

It may well not be cost-effective to treat all grain immediately after harvest but rather only the proportion of the produce which is to be stored for three months or more. Such advice helps the farmers to decide on actions to be taken, encouraging assessment of the need to store or sell, given market prices, the quantity harvested and so on.

For the last 20 to 30 years, it has been a standard recommendation that farmers should treat the crop to be stored with an organophosphate (OP) dust. Several OPs, including malathion, fenitrothion, iodophenphos and pirimiphos-methyl have been approved by the UN Codex Alimentarius Commission for application to raw cereal grains, flour, pulses and some oilseeds; acceptable daily intakes and maximum residue limits have been prescribed. Many of these compounds are commonly applied as sprays for other agricultural purposes. However, it requires the use of a sprayer which most farmers do not possess or cannot afford. Furthermore, spraying requires dilution of an insecticide concentrate, a hazardous process especially for untrained small-holder farmers. Dilute dusts are composed of at least 95 percentage inert material. They are therefore very bulky, difficult to package in quantities suitable for an individual producer's needs, and difficult to distribute to rural communities at a time when they are most needed and to where they can be conveniently obtained. Families frequently complain they have no access to insecticides when they want to apply them, and whatever little is available is expensive. Farmers who cultivate cash crops or have other sources of income may be able to afford these high prices, but most farmers in the semi-arid tropics are poor and do not have cash or credit to be able purchase insecticides. During the last decade, efforts have been made to identify alternative methods of protecting grain against insect damage which are of low or no cost to the farmer and are therefore likely to be acceptable and utilised. Furthermore, these methods are more environmentally sustainable and less of a health risk than the synthetic insecticides.

Botanical pesticides:

Throughout the developing world, farmers have traditionally used the plants and trees around them as sources of insecticides. The number and type of species used for this purpose is considerable. The literature contains many references to the effect of plants on storage insects (Dales, 1996), but this work is mostly confined to laboratory investigations. There is very little direct evidence which demonstrates that plants used by farmers are effective grain protectants. Few studies have been conducted to replicate farm methodologies, one reason being that farmers themselves are uncertain of the details of the methods and can only provide subjective assessments of effectiveness.

Plants with known insecticidal or repellent properties include: *Securidaca longipedunculata*, *Chrysanthemum cinerariaefolium* (pyrethrum), and *Azadirachta indica* (neem). Both pyrethrum and neem are relatively unstable and may not be suitable for long term grain

storage. Although more than 130 plants have been reported as being used as storage protectants, only pyrethrum and neem have been used commercially. In some countries, palm and coconut oils are used to protect grain, particularly those for seed. However, they are usually considered too costly for storage insect control.

Mechanical control:

Sieving, winnowing combined with sun drying, sticky bands, water traps and baits can be used for insect control in storage. Turning grain to interrupt population development is quite feasible for bulk grain in silos.

Physical control:

Low and high temperatures (> 60°C) inhibit development, and may kill several insects. Dusts such as ash, sand and other mineral powders can be used to fill the interstitial spaces in grain bulk. These provide a barrier to insect movement and damage the insect cuticle causing death by dehydration. Diatomaceous earths (naturally occurring aluminium silicates) absorb waxes from the insect cuticle and cause death by dehydration. These are 'Generally Regarded As Safe' (GRAS) by the US Environmental Protection Agency for use with grain.

4. References

- Bennett, W.F., Tucker, B.B. and Maunder, A.B.** (1990). *Modern Grain Sorghum Production*. First Edition. Iowa State University Press. Iowa, USA.
- Codex Alimentarius Commission.** (1989). Standard for sorghum. 172-1989.
- Daiber, K.H. and Taylor, J.R.N.** (1995). Opaque beers. *Sorghum and millets: chemistry and technology*. Dendy, D., ed. American Association of Cereal Chemists.
- FAO.** (1995) 1995 FAO statistics. Rome, Italy.
- Giresh.** (1990).
- Gupta.** (1977).
- Hallgren, L.** (1995). Lager beers from sorghum. *Sorghum and millets: chemistry and technology*. Dendy, D., ed. American Association of Cereal Chemists.
- Hulse, J.H., Laing, E.M. and Pearson, O.E.** (1980). *Sorghum and the millets: Their composition and nutritive value*. Academic Press.
- McFarlane, J.A., John, A.E. and Marder, R.C.** (1995). Storage of sorghum and millets: including drying for storage with particular reference to tropical areas and the mycotoxin problem. pp. 169-183. *Sorghum and millet: Chemistry and Technology*. Dendy, D., ed. American Assoc Cereal Chemists Inc.
- IFS.** (1991). *Proceedings of a Regional workshop on Traditional African Foods - Quality and Nutrition*. 25-29 November 1991. Westby, A. and Reilly, P.J.A., eds. International Foundation for Science.
- Kerehero, M.M. and Mtebe, K.** (1994). Acceptability of wheat-sorghum composite flour products - an assessment. v. 46 (4): 305-312. *Plant Foods for Human nutrition*. Netherlands.
- Munk L.** (1995). New milling technologies and products: Whole plant utilisation by milling and separation of the botanical and chemical components. *Sorghum and millets: chemistry and technology*. Dendy, D., ed. American Association of Cereal Chemists.
- NRI.** (1998). Small scale manufacture of animal feed. *Bulletin No 9*. Natural Resources Institute (NRI), Chatham, Kent, England, UK.
- Osman.** (1984).
- Pushpama, P.** (1987). Supplementary foods in India. pp. 69-77. *IDRC monograph*. No 249e.
- Recommended International Code of Practice.** (1985). *General Principles of Food Hygiene*. (CAP / RCP 1-1969, Rev. 2, 1985).
- Sautier, D. and O'Deye, M.** (1989). *Mil, Mais, Sorgho - Techniques et alimentation au Sahel*. pp. 171. Harmattan. Paris, France.

- Schmidt, O.G.** (1988). Sorghum processing , Botswana. *IDRC Monograph. The greening of aid sustainable livelihoods in practice.* pp. 128-133. Earthspan Publications. London, UK.
- Vogell, S. and Graham, M.** (Editors). (1979). Sorghum and millet -Food production and use. Proceedings of a workshop held in Nairobi 4-7 July 1978. pp. 64. IDRC. Ottawa, Ontario, Canada.
- Watson, S.A.** (1970). Wet-milling and products. *Sorghum Production and Utilisation.* Wall, J.S. and Ross, W.M., eds. Avi Publ. Co. Westport, CT, USA.
- Wood, J.F. and Thomson, M.** Unpublished data. Natural Resources Institute (NRI). Chatham, Kent, England, UK.

Industrial use of sorghum

Organisation: Sorghum Institute of LAAS

Author: Jianqiu Zou & Yuxue Shi

Edited by AGSI/FAO: Danilo Mejia (Technical), Beverly Lewis (Language&Style),

1. Introduction

Sorghum (*Sorghum bicolor* (L) Moench) is a globally cultivated cereal that is called a 'Life Saver' in some areas. It is a major crop grown in the semi-arid and arid regions of Africa and Asia where it is used as a staple food. In China, sorghum or kaoliang, is one of the earliest cultivated crops growing mainly in Northeast, Northwest and North China temperate zones. Chinese sorghum production is based on grain sorghum, to sugar-refining sorghum, forage sorghum and craft sorghum. It is a unique due to its tolerance to drought, waterlogging, saline-alkali, infertile soil and high temperatures. Sorghum can obtain a consistent high yield even in certain semi-arid and arid areas where rice, wheat and corn are not well adapted. Sorghum plays an important role in crop rotation systems. Sorghum is a C4 species with high photosynthesis efficiency. It can achieve higher yields with a lower input of resources in compared to other crops.

Most grain sorghum in China is used as food to make various breads, cakes, dumplings and noodles. But sorghum is commonly called "coarse food "because of its amino acids imbalance and high tannin content (Table 1).

Table 1. The Composition of Chinese Sorghum Resources and Hybrids

		Starch %	Protein %	Lysine % Tannin %
Chinese sorghum resources	the highest	16.30	0.43	1.29
	the lowest	6.62	0.10	0.04
	mean	11.46		
Hybrids	the highest	15.20	0.41	2.64
	the lowest	6.50	0.07	0.03

In recent years, Chinese sorghum researchers have directed their attention to improving sorghum quality by breeding and processing. Obvious improvements have been gained (14). Sorghum kernels provide good concentrated feed similar to corn in nutritional value. Sorghum stalks and leaves can be used as green fodder, ensilage or hay.

In China, making strong liquors from sorghum kernels represents a long history and high technological level. The world famous Maotai and Fen liquors are made from sorghum. Its by-product of distillers' grain can be used as high quality feed. Sorghum grains produce starch, starch noodles and vinegar.

Chinese Kaoliang is a special sorghum group in the world. There are about 17 thousand sorghums cultivars in China, the representatives of them are: *Guandong Qing*, *Luyi Waitou*, *Shanchishan*, *Wawa kaoliang*, *Bakecha*, *Xiaongyue 253*, *Fenzhi Dahongsui*, *Xiang Kaoliang*, *Zhuyeqing*, *Hongke Nian*, *Waibo Zhang* and etc. (7, 11).

Chinese sorghums have great variety of panicles (Fig. 1) (4), growing periods, plant heights, head lengths, and 1,000-kernel weights (Table 2) (2). Typically they are high dark red soft glum, white vein and dry pith.

Figure 1: The Sketch Map of Chinese Kaoliang Spike

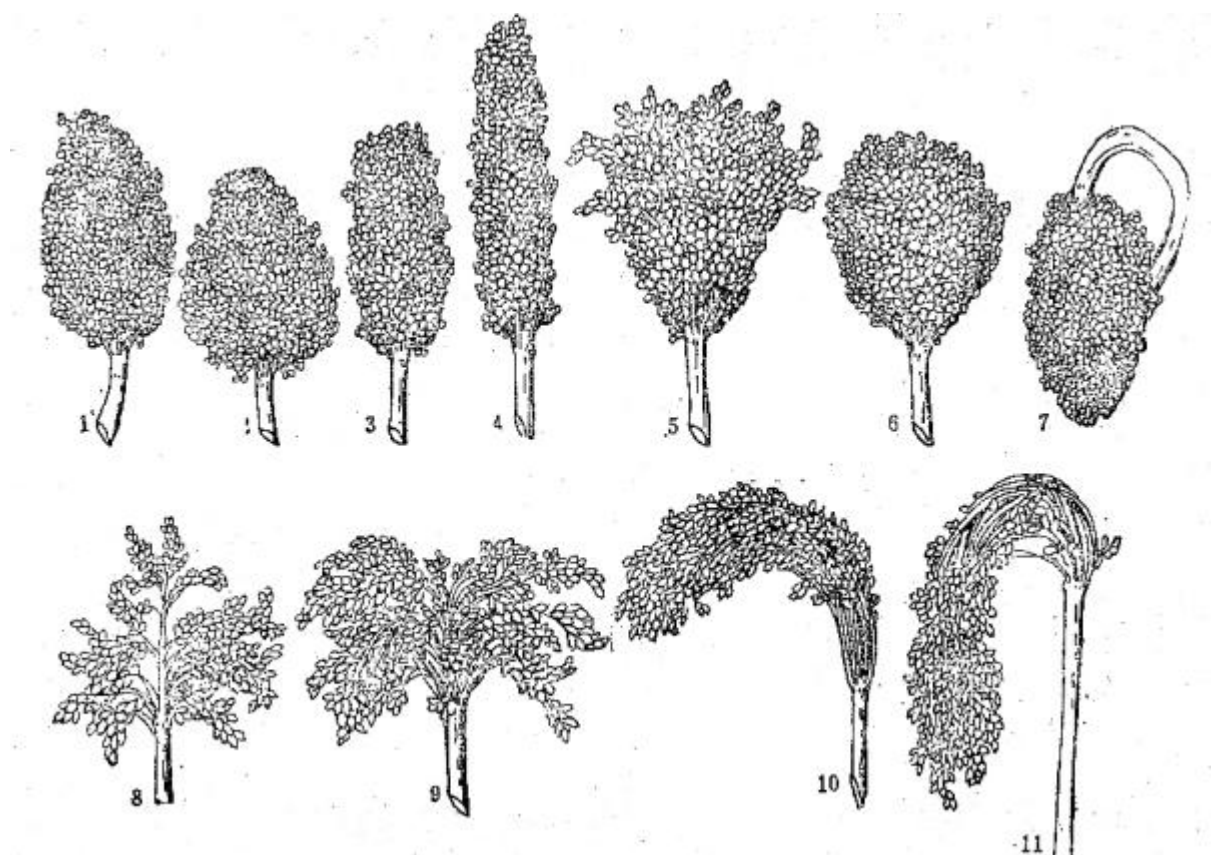

1. Spindle 2. Heart 3. Cylinder 4. Stick 5. Cup
6. Spherical 7. Elbow 8-9. Umbrella 10-11. Broom

Table 2. Structural Features of Chinese Sorghum

	Growing period day	Plant height cm	head length cm	length 1,000 kernel weight g
Max.	166	435	50	39
Min.	88	92	11	12
Mean	115-125	250-300	22-33	21-26

1.1 Primary product

Milling is very important in China, because many sorghum foods are made of decorticated sorghum and sorghum flour. Milled sorghum is usually decorticated to remove the pericarp, followed by crushing of the decorticated grains into flour.

Milling machines can be divided into three types: friction milling (pressure system), grinding milling (speed system) and mixed milling.

Friction milling decorticates grains depending on the friction between components and grains or between grains. The method suits the corneous endosperm variety. Peeled grains from this method are smooth, even, with less breakage and higher milling yields.

Relying on its hard, concentrated and sharp edges, the emery roller in grinding milling cuts pericarps repeatedly by relative motion at a set speed, so the pericarps are removed. The method is suited to floury endosperm varieties. The decorticated grains derived from this method are rough and uneven with poor colour.

Mixed milling was invented by China combining the advantages of grinding milling with friction milling, with stress on the former. It is a good milling method with a great future.

There are two kinds of dry flour milling methods: whole grain flour milling and decorticated grains flour milling. Making flour from whole grains can yield 90 percentage, but digestibility is low at 18.55 percentage with poor flavour. Making flour from peeled sorghum grain can produce high quality flour with good digestibility, but yields 8.5 percentage.

The wet flour milling method is better than dry milling. Flour produced by this method is good quality with white, fine grains and 5 percentage higher digestibility than dry milling.

The flour is easy to store. The procedure of wet flour milling is described in Figure 2. (4).

Unprocessed grains ->	Cleaning - >	Washing - >	Heating - >	Making flour - >	Drying - >	Packaging
--------------------------	-----------------	----------------	----------------	---------------------	---------------	-----------

Figure 2: Processing Method of Wet Flour Milling

Traditional sorghum foods

Sorghum is a staple food crop in China, especially in North China. People there can make many kinds of rich and colourful sorghum foods which have different flavours. According to Shukun Zhao (12,13), there are about 40 kinds of sorghum foods. Table 8 summarises some different sorghum foods.

Table 8 Classification of Sorghum Foods

Type		Name of representative
decorticated grain foods	cooked produces porridge	gan mifan, lao mifan, shui mifan, er mifan dou mifan chazi zhou, doumi zhou, ermi zhou, Jianmi zhou, naibuzi.
flour foods	steamed products boiled products baked products parched products glutinous products	YuYu, baocha, wowo, tiaotiao, jiaozi, dundun, boboye, fagao hele, miantiao, mianpian, gangsimian, miangedatang, daoxuemian, suantangzi jianbing, famianbing, dabingzi chao mian, youchamian niangao, niandoubao, nianhuoshao, nianbing, suhaozi
Popping foods		penghuasu, baomihua, chaomibua

1.2 Secondary and derived product

In China, almost every part of sorghum can be used (Table 9 and Figure 3).

Table 9 Utilisation of Sorghum By-Product

Sorghum component	Utilisation
root	fuel
stalk	fuel, mat, hat, building materials, frame materials, barrier
peduncle	cover
threshed spike	broom, potscouring brush



Figure 3: Articles Made of Sorghum By-products

1. Broom 2. Pot scouring brush 3. Cover

Making sorghum liquor using sorghum grains

Sorghum liquor is a unique Chinese alcoholic drink with a history of about 1500 years. It is one of six kinds of world famous distillation liquor. There are many kinds of sorghum liquor in China. The characteristics of Chinese sorghum liquor are:

- a. Strictly selected materials;
- b. Meticulous processing;
- c. Excellent quality;
- d. Special flavour;
- e. Very strong.

The traditional ingredient of alcoholic drinks in China is sorghum. "Good liquor is always connected with sorghum" is a well-known adage. China is the first country to make distillation liquor with sorghum. Famous and precious sorghum liquors of China include (4,9,15):

Maotai: It was produced in Guizhou province, in 1704. In the International Fair of Panama between 1915 and 1916, Maotai gained the second prize in the competition and was elected

World Famous Liquor. It is the most famous liquor in China served at state banquets. The key ingredient of Maotai is local high quality sorghum.

Fen Liquor: It is manufactured in Shanxi province, China. It has the longest brewing history (about 1500 years). In the International Fair of Panama of 1915, it won the First Class Gold Medal.

Wuliangye: It is made in Sichuan province of China. It was awarded the Gold Medal in the International Fair of Panama in 1915. It uses five kinds of crops as materials (Sorghum, glutinous rice, rice, corn and wheat). 60 percentage of Wuliangye is sorghum.

Jiannanchun: It is also made in Sichuan province of China. It begun to be produced 300 years ago in Qing dynasty. Its materials are five crops: Sorghum, rice, corn, wheat and glutinous rice, Sorghum accounts for 40 percentage of the recipe.

Xi Feng: It is produced in Shanxi province. It won second prize in Southeast Asia Competition of 1909. It is made exclusively from sorghum.

Luzhouliqu: It is produced in Sichuan province of China. It has about a 300-year history. It won the Gold Medal and Certificate of Merit in the International Fair of Panama in 1919. Sorghum and corn have very similar composition, but for making liquor, sorghum is better than corn. First, sorghum has a lower protein and lipids content than corn. During the fermentation, protein is hydrolysed for amino acids, and then the amino acids are changed into senior alcohol. These senior alcohols are the main source of the liquor flavour. If the protein content is too high, too much mixed alcohol will be produced, and the high mixed alcohol content in the liquor will produce white sediment in lower temperatures. Similarly, if the lipid is too high, a lot of fatty acid is produced causing a bad smell and white precipitate. So, suitable protein content will benefit distillation. Second, and most important, sorghum has a small tannin content (about 0.5~2.0 percentage). Tannin inhibits harmful micro-organisms and increases liquor-making productivity. Tannins also produce some aromatics which give sorghum liquors their special flavour. The general method of making sorghum liquor is described in Figure 4.

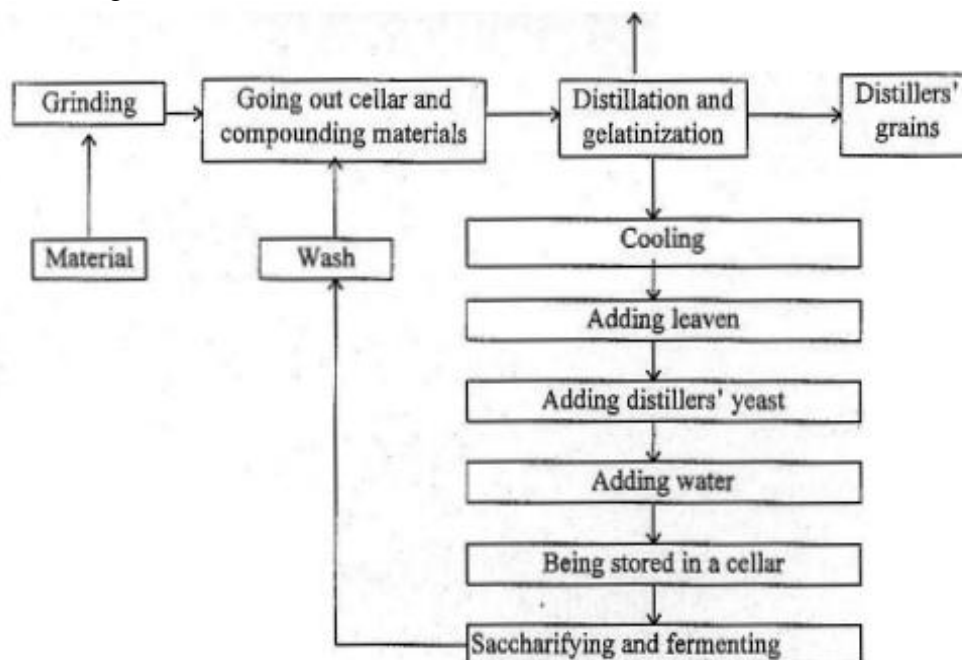

Figure 4: Flow Diagram of Sorghum Liquor Making Process

Making liquor using sweet sorghum stalk and waste residue from sugar refining

Sweet sorghum stalks have a high sugar content good for making liquor. Usually, 4.5-5.0 kg 62 percentage liquor can be distilled using 50-kg sweet sorghum stalks. The method is similar to using sorghum grain (Figure 5). The advantages of processing sweet sorghum stalks on the spot are that the residue can be used to produce methane, feed or manure. Moreover, the waste residue of refining sugar also contains some sugar, which can be fermented for sorghum liquor. About 1.5-2.5 kg 50 percentage sorghum liquor will be produced from 50-kg waste residue (4).

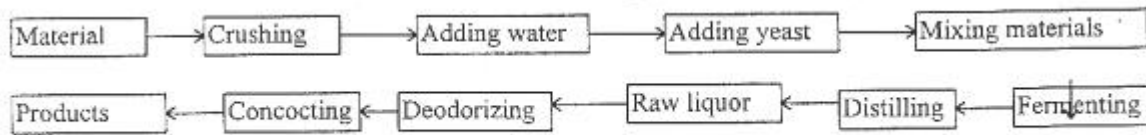

Figure 5: Processing Method of Liquor Using Sweet Sorghum Stalk

Making liquor using sweet sorghum stalk

Here the juice of stalks is directly fermented and then filtered (Figure 6).

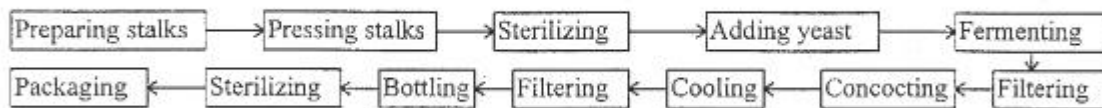

Figure 6: The Processing Method of Making Keller Liquor

Making Liquor By Sorghum Bran

Sorghum bran is a by-product of milling sorghum where generally, more than 20 percentage sorghum bran will be derived. The composition of sorghum bran is 40~ 60 percentage starch, 11~ 15 percentage raw protein, 4~ 10 percentage raw lipids and higher tannin content. Because the high content of lipids in sorghum bran cause too much acid, the temperature of cellar should be lower to guarantee the quality of the liquor (4).

Brewing beer

Traditional brewing ingredients of beer are barley and rice. Along with the development of the beer industry, there were insufficient resources. Sorghum is a new potential substitute for barley or rice, which can not only resolve the ingredient problem, but also raise economic benefits (10).

Although there is a traditional sorghum beer in Africa, it is an acid type of beer quite different from traditional beer in Europe. Chinese sorghum beer is similar to European beer. Its colour, flavour and quality are similar to barley beer. The brewing method is as follows (Figure 7).

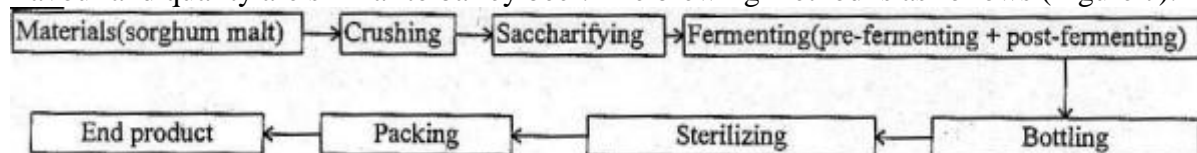

Figure 7: Brewing Method of Sorghum Beer

Refining sugar

Making syrup from sweet sorghum stalks has a long history in China, but the production of crystalline sugar is only several decades old. There are three end products in sugar refining-- yellow granulated sugar, brown granulated sugar and syrup. Their quality was up to standard.

The total sugar in crystalline sugar can generally reach about 92 percentage (82.09 percentage sucrose+10.5 percentage reducing sugar), and water content is about 7 percentage (4).

The sugar extracting productivity with sweet sorghum stalks is about 4 percentage (1). Figure 8 gives the details of sugar refining.

Making vinegar

Vinegar with its acid flavour can whet the appetite, help digestion, or assist medicine. A large amount of high-quality vinegars in North China are made from sorghum grains.

Sorghum vinegars are thick quality, mellow flavour and full of delicate fragrance. Shanxi Old Mature Vinegar is one of the most famous Chinese sorghum vinegars.

To make vinegar get ethanol from the starch by fermenting. Ethanol becomes vinegar by oxidisation. So, its processing method is similar to making sorghum liquor. Besides sorghum grains, many kinds of residues from sugar extraction, such as sediment foam, also can be used to manufacture vinegar. About 1.3-1.5 kg vinegar can be distilled from 1-kg sediment. Its quality is the same as vinegar made from grain.

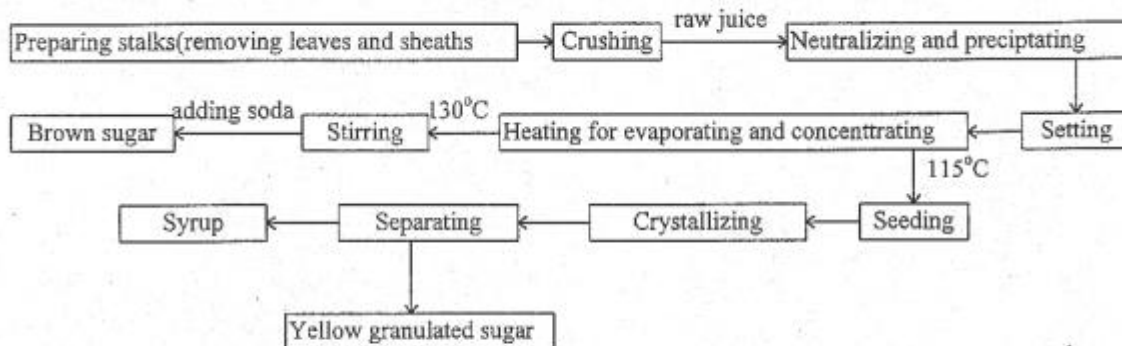
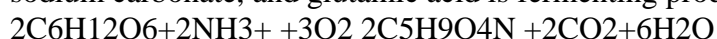

Figure 8: The Processing Method of Sugar

Making monosodium glutamate

Monosodium glutamate (MSG, $C_5H_8O_4NNa.H_2O$) is the reactant of glutamic acid and sodium carbonate, and glutamic acid is fermenting product of glucose ($C_6H_{12}O_6$).



In China, the raw component to make monosodium glutamate is starch, such as rice, corn and sorghum. If we use sweet sorghum stalks to make MSG, it should be very convenient, because the process from starch to sugar can be omitted. What we need to do is transform sucrose to glucose. If the yield of sweet sorghum stalk is 75,000 kg/ha, grain yield is 4,500 kg/ha, the output of MSG will be $243.8 + 80.4 = 324$ kg. It is 2.5 times more than rice which is a considerable economic benefit.

Making Sorghum Sweetmeat

In ancient China, people made malt sugar as a food; its other name is water malt sugar. Any kind of starch can be used make maltose. Because maltose has very strong hygroscopicity and gentle sweet taste, it is one of the necessary constituents in candy, cake and jam. Sorghum sweetmeat, a kind of maltose made of sorghum starch, is a famous special local product from the Shandong province. The main composition of sorghum sweetmeat is maltose (about 50~65 percentage) and dextrin (about 20~25 percentage). It also contains some moisture and a small amount of protein, starch, and ash (4).

Making paper

The leaves and stalks are the materials of the grass family paper making, which can be used to make writing paper (rough straw paper), wrapping paper, and other products. In addition, the residue which from sugar refining of sweet sorghum stalks is also used for papermaking. Comparing other papermaking materials, sorghum leaves and stalks are easy to convert into pulp. Size chemical pulp use only a small amount of chemicals to fabricate paper products that are homogeneous and smooth. However, the paper made from sorghum stalks and leaves show strong transparency and brittleness plus poor folding and bursting. The process of making paper is described as Figure 9 (4).

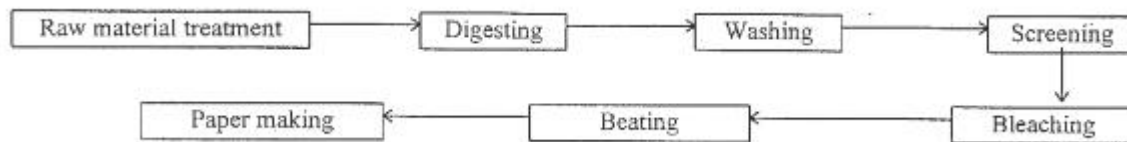

Figure 9: The Method of Making Paper Using Sorghum Leaves and Stalks

Making plywood using sorghum stalks

The cellulose content in sorghum stalk is very high, at about 48 percentage of dry weight (4). Sorghum stalks are not only light, but also pliable and hard. Sorghum stalks can be used to produce sorghum plywood. Comparing shaving board and fibreboard, sorghum plywood has many advantages.

- A. Light with high strength;
- B. Better insulation capability;
- C. Highly durable;
- D. The size, thickness and specific gravity of board are suitable for multi-function applications;
- E. The holding power of nails and screws is generally lower than that of wood board;
- F. Tropical rainforests for wood making materials are conserved.

The material used for sorghum plywood is from sorghum stalks. Sorghum is an annual plant with great deal planted all over the world making it simple to get raw materials for plywood. On the other hand, sorghum stalks are by-products of sorghum. By using sorghum stalks to make plywood, farmers can earn 3000 yuan/ha more than before. Because sorghum plywood is a substitute for woodboard, it can reduce the use of wood materials to conserve acres of forests.

Shenyang Xinyang Sorghum Plywood Company Ltd., which is a joint venture of China and Japan, can produce about 60,000-m³ plywood each year. Their processing method is described in Figure 10. The sorghum plywood can be used to construct tables, doors, furniture and decorative materials (Figure 11).

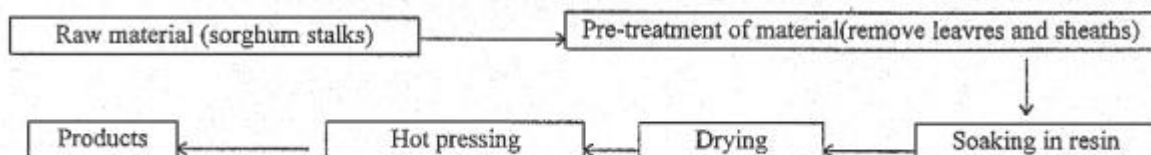

Figure 10: The processing method of sorghum plywood

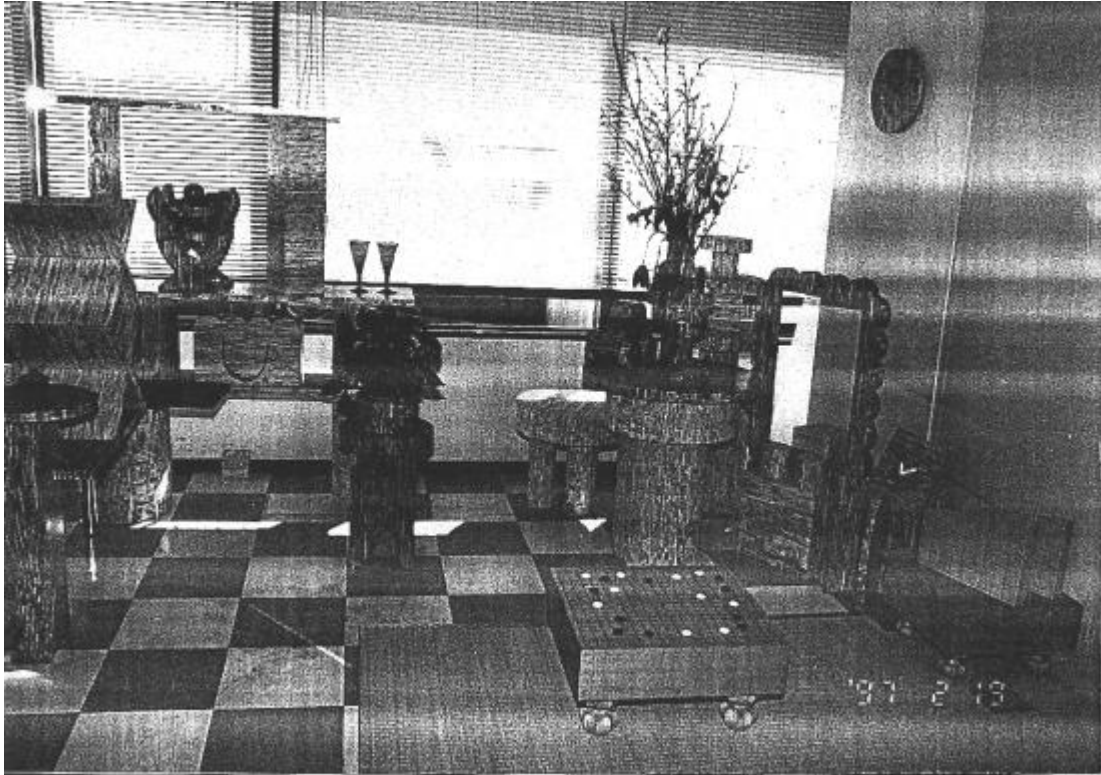

Figure 11: The Furniture and Ornament Made of Sorghum Plywood (the picture is kindly provided by Shenyang Xinyang Sorghum Plywood Company Ltd.)

Making alcohol

The oil crisis is a world-wide problem, creating urgency to seek new replaceable energy source with no delay. Alcohol can partly replace oil. So the challenge is how to get enormous volumes of alcohol? Sorghum is an efficient material in making alcohol.

Making alcohol using sorghum grains

In China, the main method to make alcohol is fermenting starchy materials. (Figure. 12). Because of its high starch content, sorghum grains are an important material of making alcohol. Normally, 1,000-kg sorghum grains can produce 390-L alcohol (9).

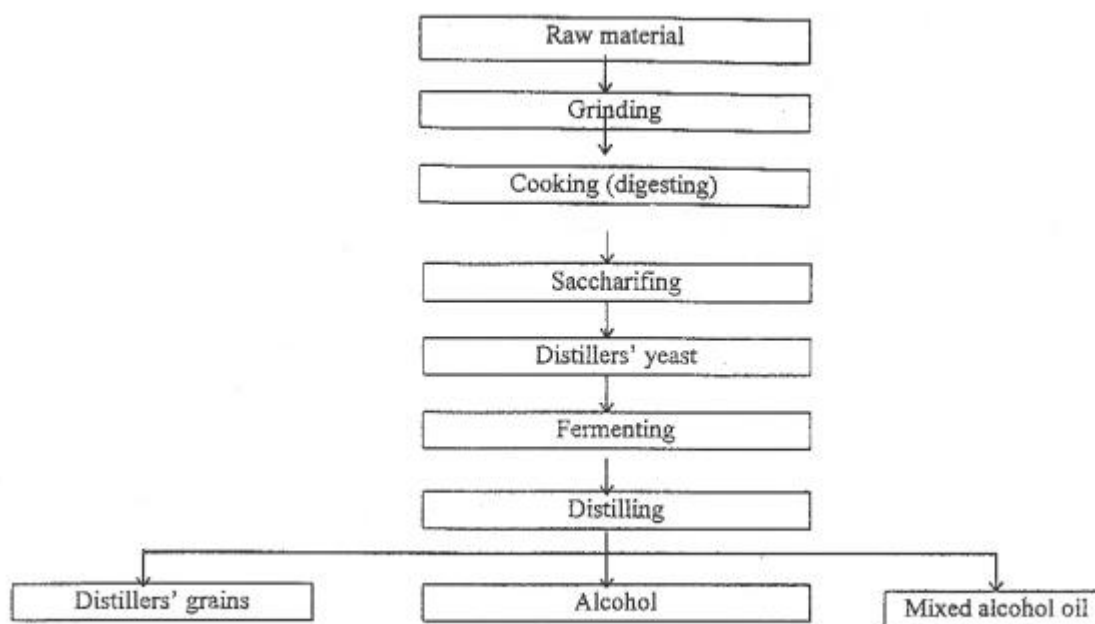

Figure 12: Flow Figure of Making Alcohol

Making alcohol using sweet sorghum stalks

Sweet sorghum is similar to sugarcane as its sugar storage organ is stalk. Sweet sorghum stalk contains considerable sugar and rich fibre. Compared to sugarcane, the advantages of sweet sorghum are:

- A: it reproduces with seeds, do not use stalk as seedling;
- B: growth period is only half of sugar cane.

Figure 13 is flowing diagram of using sweet sorghum stalks to make alcohol (4)

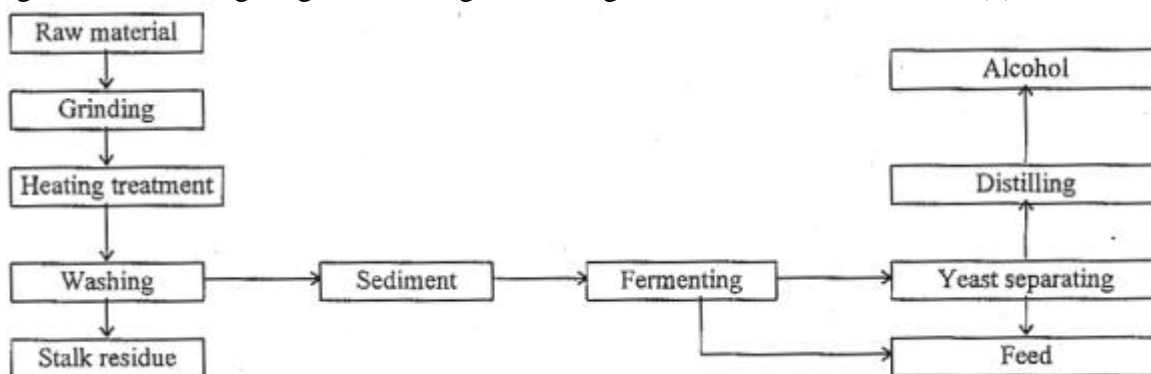

Figure 13: Flowing Diagram of Making Alcohol by Using Sweet Sorghum Stalks

In this procedure, the process of converting starch into sugar is eliminated shortening the producing time. The stalks can be utilised comprehensively. For example, the juice of the stalks cane used to produce alcohol and nitrogenous fertiliser which can satisfy the need of crops or herbage, leaves and residue may be used as feed, waste is used to produce methane used to generate electricity. So, the main products of pastureland are not only livestock products, but also liquid fuel. It takes about 18.2 tons sorghum stalks to produce one ton alcohol, the net income is 300-yuan (1).

Extracting pigments from sorghum glume

Most of sorghum pericarps and glumes are coloured, According to variety, their colour can be dark to light, such as brown, red, yellow, and white. Sorghum pigments belong to isoxanthoketone galactoside which has many kinds of components. In ancient China, people found glume pigment sorghum to be very stable useful to dye woollens, cotton, linen, and other textiles. However, most of sorghum glumes are either discarded or used as fertiliser, because no suitable pigment extracting method. In recent years, researchers in Sorghum Institute of Liaoning Academy of Agricultural Science have done a great deal of research work about pigments on its physiochemical properties, extracting methods and applications. They successfully extracted pigments from sorghum glumes, named Sorghum Red Pigment (Figure 14) (3). After the pigments extracted, sorghum glumes can be reused. For example, if one can use sorghum glumes as material for making vinegar and extracting glue, or as fillings to produce mushrooms. When it encounters light and heat, the pigments keep stable colouring and excellent function. Along with improvement of people's living standards, edible pigments are evolving from synthetic pigments to natural pigment. It is because synthetic pigments are harmful to human's health. People are more and more interested in natural pigments. Based on Chinese Law, synthetic pigments are not permitted to be used in food and cosmetics. Extracting pigments from sorghum glumes provides a good way for people to get treasures from waste.

Sorghum Red Pigment is dark red powder with natural soft colour, containing no poison or no special odour, which is able to be used in foods, meat products, beverage, cosmetics, medicine and textiles.

The main components of sorghum red pigment are 5,4'-dihydroxy-7-0-isoxanthoketone galactoside (molecular formula: C₂₁H₂₀O₁₀, molecular weight: 432.37) and 5,4'-dihydroxy-6, 8-dimethoxy-7-0-isoxanthoketone galactoside (molecular formula, C₂₃H₂₄O₁₂, molecular weight, 492.42), Their structural formulae are described as Figure15 (2).

Material (sorghum glumes) Cleaning Washing Extracting Filtering
 Concentrating Centrifuging Drying Sterilising Inspecting Packing
 Products

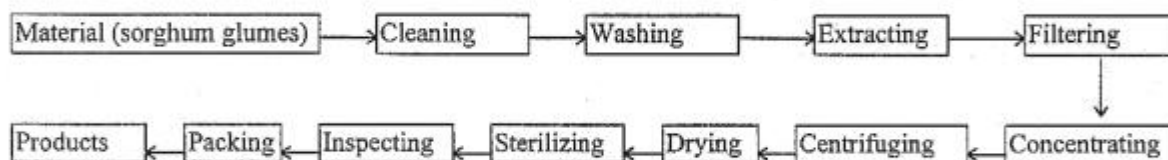
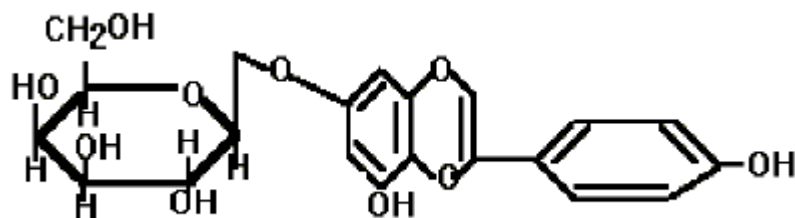

Figure 14: The General Extracting Method of Sorghum Red Pigment

(1) 5,4'-dihydroxy-7-O-isoxanthoketone galactoside



(2) 5,4'-dihydroxy-6, 8-dimethoxy-7-O-isoxanthoketone galactoside

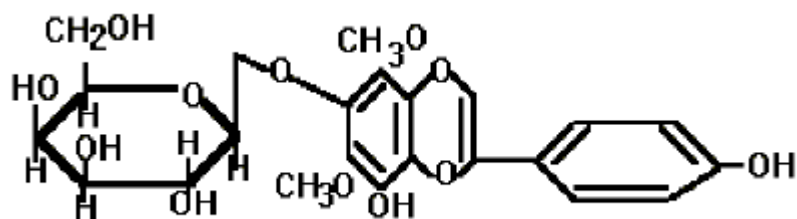

Figure 15: The Structural Formulae of Sorghum Red Pigments

In 1992, The Extracting Technology of Sorghum Red Pigment declared their invention patent. In 1995, Liaoning Keguang Natural Pigment Company Ltd. was established, which is a joint venture of Liaoning Academy of Agricultural Sciences, China and Koyo Shangyo Company Ltd., Japan. Their products fall into two series: alcohol soluble (A) and water soluble (W), produced through 6 technological processes. A-100, A-200, W-300, W-400, W-500, etc. are the main varieties sold at home and abroad. Annual output of natural Sorghum Red Pigment is more than 20 tons. Both economic performance and social effects are good. Following is some applications of Sorghum Red Pigment (6).

Meat products

Between August and November 1992, Shenjin Meat products Factory of Shenyang used Sorghum Red Pigment researched by Sorghum Institute, Liaoning Academy of Agricultural Science as an additive for ham, (The dosage was 0.34 g Sorghum Red Pigment in one kilogram ham.) roasted 400 kg ham at 3000C, which expresses soft nature tone and reality.

Cosmetics

Baita Daily Chemical Product Factory successfully used Sorghum Red Pigment on lipstick and shampoo. The Products has soft and bright colour, therefore natural Sorghum Red Pigment is thought to be a substitute of synthetic pigment in cosmetics.

Medicine: Using as colouring agent of sugar-coated tablets and capsules

In November 1992, Shenyang Pharmaceutical College successfully used Sorghum Red Pigment as colouring agent of sugar-coated pills. In March 1994, Tiexi Capsule Plant of Shenyang, added 4.6 g Sorghum Red Pigment per kilogram Capsule, got ideal results. The product is dark red, smooth, with no unpleasant door, no gaps or shapelessness. When inspected, every target adheres to national standards.

Using as Colouring Agent of Traditional Chinese Patent Medicine

Xinmin Hongqi Pharmaceutical Factory used Sorghum Red Pigment as colouring agent of traditional Chinese patent medicine. The problem has been resolved for the colour tone match of traditional Chinese patent medicine to pharmaceutical requirements.

Candy

In April 1993, Shenyang Bakery successfully made 10 kg fruit candy using Sorghum Red Pigment with the dosage of 0.025 g. The candy had stable colour with no unpleasant odor. The results were satisfactory.

Another confectionery manufacturer, Shenyang Dayi Manufactory, used Sorghum Red Pigment as a colouring agent of health-care candy, and got positive results. Moreover, Sorghum Red Pigment also can be used in colouring of beverage, jellies, cakes, and textiles.

2. Post-Production Operations

When sorghum grains are ripe, it is time to harvest. Using appropriate methods to harvest, thresh, dry and store at right moment, are the best guarantee of getting a high yield and good quality.

2.1 Pre-harvest operations

If the sorghum pollinates and fertilises normally, grains will form rapidly. Usually, it takes about 30-50 days from fertilising to ripening. The period includes three stages--milk stage, dough stage and ripening stage. During milk stage, sorghum grain is green or light green in colour, filled with milky liquid. At this the moment, embryo has the ability to germinate. In the dough stage the grain is slightly yellow with (almost solid and waxy) fillings. If you press the grain, it is not easy to crush which signals its ripening stage. During this stage, the head and grain appear in its original shape and colour with moisture content of 15-20 percentage. The highest accumulation of dry substance is in the dough stage, which contains about 20 percentage moisture. It is the optimum harvest time (5,8). If harvest takes place too early, the filling stage will be interrupted causing low 1,000-kernel weight, which corresponds to lower grain yield. If harvesting is too late, there will be moisture loss, natural grain falling, sprouting on the head, drought or respiration. The 1,000-kernel weight will drop, thus causing a decrease of grain yield. (Table 3) (5). Sweet sorghum, forage sorghum or ensilage sorghum, can be harvested at any time from heading stage to milk stage. The optimum time to harvest ensilage sorghum is at the end of the milk stage to obtain the highest biomass and nutrition. If grains are intended to be used as food and the stalks and leaves as ensilage, then the optimum harvest is at the end of the dough stage (4).

In addition, different harvest time will affect grain quality and viability. Premature harvesting will result in protein content that is a little higher while starch content and unit weight is lower. By slightly delaying harvesting time, starch content and unit weight are almost same, but protein and soluble sugar content drop. Late harvested sorghum measures lower for all indices (Table 3). In addition low temperatures decrease germination rate. Grains for seed must be harvested at the right time.

Table 3. The Influence of Harvest Time to Sorghum Grain Quality of Xiongyue 253

Harvesting time	Grain yield (%)	Unit weight(g/L)	Moisture (%)	Starch (%)	Soluble sugar (%)	Protein (%)	1,000 Kernel weight (g)
Early milk stage	100.0	700	66.6	66.6	1.41	8.63	7.5
Late milk stage	123.9	727	37.5	70.2	1.50	7.79	26.0
Middle dough stage	144.6	744	33.3	72.0	1.62	7.86	29.0
End of dough stage	162.1	741	20.0	72.9	1.50	7.74	29.0
Ripening stage	160.9	739	13.0	68.4	1.41	7.76	29.5

2.2 Harvesting

In China, there exist two harvest methods--traditional hand cut and mechanical harvest. At present, the dominant way is manual harvest:

- a. The harvest tradition of the Chinese;
- b. Reflects the economic situation, as many Chinese farmers are still poor;
- c. Most of planting fields for sorghum are on hillsides and fields are too small to harvest with machines;
- d. Too many sorghum cultivars are planted, and sometimes plants are not in good condition;
- e. There are not enough satisfied harvesters.

Manual harvesting cuts sorghum with a sickle. The first method is harvesting the plants with their heads on. The method is to cut plants first, then bind 20-30 plants together. After binding all the plants, a vertical rafter is made using 25 bundles for drying the sorghum in the field. If rainfall is not too great, the farmers put sorghum bundles on the ridge of the field for drying. The height of stubble is diverse. If the stubble is used as fuel, the stubble height will be 30 cm, otherwise, it will be 10 cm. After drying about 10 days, the heads are cut (about 50 cm long) and bound. Then the heads are sent to threshing site. This method can clear the fields allowing farmers to prepare fields for the next season. It is the most popular production method.

In the second method the sorghum heads are cut first tied up and dried. The straws are cut last. The method is primarily used in the coastland, low-lying land and southern China. Sometimes, the method is also used to harvest the short-stalked variety.

In some areas of Henan, Shanxi and Shandong province, the farmers dig the whole sorghum plants with roots, and then cut the heads in order to get more fuel,

Two kinds of mechanical harvesters are used in China. One is designed for short-stalked sorghum, the other for long-stalked sorghum. The advantages of mechanical harvest are efficiency and fewer losses.

The Dongfeng combine harvester is for short-stalked sorghum demanding sorghum less than 100 cm. However most Chinese sorghum cultivars have medium-long-stalks of 180-250 cm high. This machine is seldom used.

The Liaoning 4G-4 sorghum harvester is used for long-stalked sorghum varieties. Its efficiency is not as high as the combine, but it has only 15 kg grain loss per hectare. Today, the small holders and subsistence farmers use the traditional hand cut method. Harvesters are used on large farms.

2.3 Threshing

After being fully dried in the sun, sorghum needs to be threshed. The threshing methods can be divided into artificial threshing, animal threshing and mechanical threshing. Along with the rise of mechanisation, more and more farmers use mechanical threshing machines. Table 4 details different threshing methods (4).

2.4 Drying

Grain drying is the key to ensure good storage quality. Without drying, the moisture content of sorghum grains remains too high. The grains generate heat because of its respiration and a great amount of nutrition is wasted, so the edible and seed grain qualities decrease.

Natural drying is usually used for sorghum production, in the case of small holders and subsistence farmers. They spread sorghum grains out about 10 cm thick. To increase the irradiated area of grains, some small ridges can be made from south to north. Then they turn the grain over again and again to decrease moisture more rapidly. After 3~4 days when the moisture content is about 13 percentage, the grain is ready to store.

More and more grain depots and seed companies use mechanical drying. There are 8 kinds of dryers shown in Table 5.

Different sorghum cultivars should be dried separately. Also to speed up the drying process, the grains with different moisture content should be treated separately.

Table 4: Difference of Three Sorghum Threshing Methods

Threshing tools	Threshing Method/Procedure	Threshing output (kg/person)
Artificial threshing flail wooden fork	Spread sorghum heads in the threshing field, dry in the sun for half a day, then beat sorghum heads with flail. After most of grains have been threshed, turn over sorghum heads, beat sorghum heads again. Repeat these steps until all the grains are threshed . The method is inefficient and labour intensive, so it is seldom used now.	Threshing output (kg/person) 250
Animal threshing livestock stone roller wooden fork	Spread sorghum heads on threshing field (about 25-35 cm thick). Then let livestock pull the stone roller (rolling and pressing). When most of grains are threshed, turn over sorghum heads. Roll stone roller again, until all of grains are shelled. This is the most popular method in China.	Threshing output (kg/person) 1000
Mechanical threshing drum thresher large cereal- thresher	Place sorghum heads into thresher. Inspect the heads frequently to see if all the grains have been threshed. Monitor if there are crushed grains. The advantages of the method are high efficiency, clean threshing and low glumaceous rate.	Threshing output (kg/person) 4000

2.5 Cleaning

In the course of harvest, storage, and transportation, many kinds of impurities can easily enter the crop. Cleaning becomes a necessary step to ensure grain quality and machine safety.

In sieve cleaning separating grains from impurities by size is the principle of the method. The most popular equipment types are the vibrating screen and holding sieve (4).

The vibrating screen is composed of a deed hopper, sieves, dust remover, cleaner and drive equipment. The sieves lie on three layers with different slopes. The slope of the first layer is 3-5 degrees for removing large foreign matter. The slope of the second layer is 4-6 degrees for screening medium-sized impurities. The slope of the third layer is 6-9 degrees for cleaning impurities smaller than the grains.

The holding sieve is suitable to unprocessed grains with more glumaceous and obstinate grains. The components are the holding sieve, rubber mill and specific gravity separator. The use of the holding sieve is to separate good grains from glumaceous or obstinate grains. The rubber mill is for dehusking. The specific gravity separator can separate glumaceous grains from obstinate grains.

The principle of pneumatic cleaning is to separate impurities using the various specific gravity values of grains and impurities. The common equipment of pneumatic cleaning is the wooden windmill, aspirating separator and model 600 double board aspirating bellows.

2.6 Storage

Sorghum grains are not only an important food crop, but also provides animal feed and major industrial material. Maintaining good sorghum grain quality for food, industry, feed and seed are the significant objectives of storage. Over the period of storage, the grains' physical and chemical changes will have major impact.

During sorghum storage, air temperature, humidity, storage microbes, storage pest and moisture content of grains are key factors which affect storage quality. Among these factors, temperature and moisture content are the most important ones. Lower temperature and moisture content are the most efficient to restrain mould growth. The lower the moisture content, the longer keeping the grains from mildewing at high temperature. For example, if grain moisture content is 13 percentage, the grain temperature should be lower than 30 °C, but when grain moisture content is 14 percentage, the highest temperature should be 25 °C.

In order to safely store sorghum, according to grain quality, utilisation, moisture content, climate, and storage equipment, different storage methods can be used. The common storage methods in China are: drying storage, low-temperature storage, sealing storage, lack oxygen-free storage, ventilating storage and chemical storage. Table 6 details these methods. (4) Generally, small holders and subsistence farmers use natural storage methods, while large producers and grain depots use natural and mechanical storage methods.

3. Pest control

While sorghum is stored, keeping pests away is a very critical task because insects, moulds, mice and birds can cause tremendous loss and pollution of grains. Table 7 presents major pest species (4).

4. References

- Li, Dajue.** (1992). *Sweet Sorghum and Its Applications*. Beijing, Republic of China. Science Publishing House.
- Li, Jinglin.** (1993). *Liaoning Agricultural Sciences*. 5: 47-49.
- Li, Shufen.** (1993). *Liaoning Agricultural Sciences*. 1: 49-50.
- Liaoning Academy of Agricultural Sciences.** (editor). (1988). *Chinese Sorghum Culture*. Beijing, Republic of China. Agriculture Publishing House.
- Luan, Benrong.** (1966). *Liaoning Agricultural Sciences*. 3: 27-29.
- Pan, Shiquan.** (1994). *Liaoning Agricultural Sciences*. 3: 50-51.
- Qiao, Kuiduo.** (1984). Research on Crop Variety Resources. *Proceedings of Sorghum Research in Liaoning Academy of Agricultural Sciences*. Vol. I: 1-11.
- Qiu, Zhaofeng.** (1964). *Journal of Crops*. 3: 437-442.
- South China Industrial College.** (editor). (1982). *Technology of Liquor and Alcohol*. Beijing, Republic of China. Light Industry Publishing House.
- The Sorghum Institute of Shanxi Academy of Agricultural Sciences.** (1986). New Utilisation of Sorghum-Research on Sorghum Beer. *Proceedings of Exchange Material of the Fourth National Sorghum Meeting*. Shenyang, Republic of China.
- Wang, Zhiguang.** (1982). *Agricultural Resources and Division*. 1: 13-17.
- Zhao, Shukun.** (1985). *Liaoning Agricultural Sciences*. 3: 50-52.
- Zhao, Shukun.** (1987). *Liaoning Agricultural Sciences*. 2: 55-57.
- Zhang, Wenyi.** (1980). *Liaoning Agricultural Sciences*. 2: 37-43.
- Zhou, Yude.** (1988). *Knowledge of Wine*. Beijing, Republic of China. Light Industry Publishing House.